

 nomet



*... z pasji do wnetrza*



Udane połączenie tradycyjnych projektów z unikalną i lekką nutą nowoczesnego designu, uważane jest za nie lada sztukę. Doskonale urządzone wnętrza to nie tylko sposób jego aranżacji, odpowiednia kolorystyka, ale także dobór najmniejszych detali, ponieważ to one wpływają na atrakcyjność i nadają mu niepowtarzalny charakter.

Projektanci Nomet przygotowali ofertę produktów, które sprostają nawet największym oczekiwaniom i w zdecydowany sposób podkreślą indywidualność naszego Klienta. Codziennie szukamy nowych rozwiązań, stosujemy nowoczesne technologie, by efektywnie wykorzystać surowce najlepszej jakości i w pełni trafić w Państwa potrzeby.

Successful combination of traditional styles with unique and light modern design is a true art. A perfect interior is not just the layout and right colours, it is also the selection of the finest details because they are decisive to the attractiveness, making the place outstanding.

Nomet designers have prepared an offer of products that will meet the most demanding expectations and to clearly mark our Clients' individuality. We specialise in searching for new solutions and apply state-of-the-art technologies to use best quality materials so as to meet all your needs.



kolekcje / collections	/	005
uchwyty / handles	/	053
gałki / knobs	/	139
listwy aluminiowe / aluminum handles	/	157
wieszaki / hooks	/	171
nogi do mebli / furniture legs	/	197
akcesoria dekoracyjne / decorative accessories	/	205





**nomet**

kolekcje / collections



## Avanti

al

index	Ø	H	P
A-1646RA1	22	28	10

G2  
chrom połysk  
glossy chrome

G3  
złoty połysk  
glossy gold

A2  
anoda złota  
anodized gold

A10  
anoda czarna  
anodized black



## Avanti

al

index	S	Ø	H	L	P
C-6541RA1	32	22	30	80	10

G2  
chrom połysk  
glossy chrome

G3  
złoty połysk  
glossy gold

A2  
anoda złota  
anodized gold

A10  
anoda czarna  
anodized black



## Avanti

al

index	S	Ø	H	L	P
Z-5435RA1	16	22	42	80	10

G2  
chrom połysk  
glossy chrome

G3  
złoty połysk  
glossy gold

A2  
anoda złota  
anodized gold

A10  
anoda czarna  
anodized black







## Avanti

al

index	Ø	H	P
A-1646RA1	22	28	10

TL33  
pastelowy beżowy  
pastel beige

TL34  
pastelowy różowy  
pastel pink

TL35  
pastelowy błękit  
pastel blue



## Avanti

al

index	S	Ø	H	L	P
C-6541RA1	32	22	30	80	10

TL33  
pastelowy beżowy  
pastel beige

TL34  
pastelowy różowy  
pastel pink

TL35  
pastelowy błękit  
pastel blue



## Avanti

al

index	S	Ø	H	L	P
Z-5435RA1	16	22	42	80	10

TL33  
pastelowy beżowy  
pastel beige

TL34  
pastelowy różowy  
pastel pink

TL35  
pastelowy błękit  
pastel blue

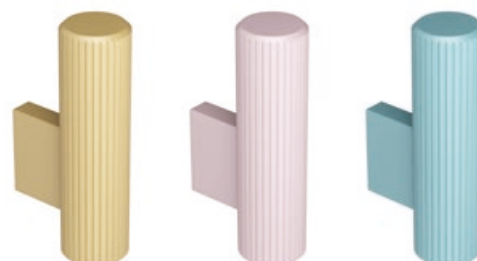





## Greta

al

index	Ø	H	P
A-1672RA2	22	25	10

A2  
anoda złota  
anodized gold

A10  
anoda czarna  
anodized black

G2  
chrom połysk  
glossy chrome



index	Ø	H	P
Z-5447RA2	22	55	10

A2  
anoda złota  
anodized gold

A10  
anoda czarna  
anodized black

G2  
chrom połysk  
glossy chrome





Wega

znal

index	S	W	H	L	P
A-1636	32	40,5	22	40	25

G4  
patyna na mosiądzu  
antique brass

G6  
chrom mat  
chrome matt

G8  
stal szlachetna  
stainless steel

G49  
cyna postarzana  
old tin

TL77  
złoto matowe  
gold matt

P59  
czarny połysk  
glossy black

P61  
czarny mat  
black matt

P67  
kość słoniowa  
ivory





## Wega

znal

index	S	W	H	L	P
C-6463	96	40	22	112	25

G4  
patyna na miedzi  
antique brass

G6  
chrom mat  
chrome matt

G8  
stal szlachetna  
stainless steel

G49  
cyna postarzana  
old tin

TL77  
złoto matowe  
gold matt

P59  
czarny połysk  
glossy black

P61  
czarny mat  
black matt

P67  
kość słoniowa  
ivory







## Sea

st

index	S	W	H	L	P
C-6562	64	50	20	100	10



index	S	W	H	L	P
Z-6909	32	50	18	70	10

P61  
czarny mat  
black matt

P67  
kość słoniowa  
ivory

P68  
antracyt  
anthracite







## Vende

al

index	Ø	H	L	P
A-1682RA2	12	25	12	10

A2  
anoda złota  
anodized gold

G4  
patyna na mosiądzu  
antique brass

A10  
anoda czarna  
anodized black



## Vende

al/znał

index	Ø	H	L	P
A-1692RA2	12	32	55	10

A2-TL77  
anoda złota-złoto matowe  
anodized gold-gold matt

G4-G4  
patyna na mosiądzu-patyna na mosiądzu  
antique brass-antique brass

A10-P61  
anoda czarna-czarny mat  
anodized black-black matt



## Vende

al/znał

index	S	W	H	L	P
C-6749-192RA2	192	12	32	252	10
C-6749-320RA2	320	12	32	380	10

A2-TL77  
anoda złota-złoto matowe  
anodized gold-gold matt

G4-G4  
patyna na mosiądzu-patyna na mosiądzu  
antique brass-antique brass

A10-P61  
anoda czarna-czarny mat  
anodized black-black matt





## Mondo

al

index	Ø	H	P
A-1656RA2	12	25	10

A2  
anoda złota  
anodized gold

A8  
stal szlachetna  
stainless steel

A10  
anoda czarna  
anodized black



## Mondo

al/znał

index	W	H	L	P
A-1626RA2	12	30	55	10

A2-TL77  
anoda złota-złoto matowe  
anodized gold-gold matt

A8-G8  
stal szlachetna-stal szlachetna  
stainless steel-stainless steel

A10-P61  
anoda czarna-czarny mat  
anodized black-black matt





## Mondo

al/znał

index	S	W	H	L	P
C-6449-160RA2	160	12	30	186	25
C-6449-320RA2	320	12	30	346	25

A2-TL77  
anoda złota-złoto matowe  
anodized gold-gold matt

A8-G8  
stal szlachetna-stal szlachetna  
stainless steel-stainless steel

A10-P61  
anoda czarna-czarny mat  
anodized black-black matt





## Torn

st

index	S	W	H	L	P
C-6259-32	16	79	28	32	10
C-6259-120	16	79	28	120	10

G73-P61  
stara miedź-czarny mat  
old copper-black matt

P61-G2  
czarny mat-chrom połysk  
black matt-glossy chrome

P68-P61  
antracyt-czarny mat  
anthracite-black matt

P68-P68  
antracyt-antracyt  
anthracite-anthracite

SS-P61  
stal szlachetna-czarny mat  
stainless steel-black matt





## Torn

st

index	S	W	H	L	P
C-6269-32	16	57	34	32	10
C-6269-120	16	57	34	120	10

G73-P61  
stara miedź-czarny mat  
old copper-black matt

P61-G2  
czarny mat-chrom połysk  
black matt-glossy chrome

P68-P61  
antracyt-czarny mat  
anthracite-black matt

P68-P68  
antracyt-antracyt  
anthracite-anthracite

SS-P61  
stal szlachetna-czarny mat  
stainless steel-black matt





## Torn

st

index	S	W	H	L	P
C-6279-32	16	151	28	32	10

G73-P61

stara miedź-czarny mat  
old copper-black matt

P61-G2

czarny mat-chrom połysk  
black matt-glossy chrome

P68-P61

antracyt-czarny mat  
anthracite-black matt

P68-P68

antracyt-antracyt  
anthracite-anthracite

SS-P61

stal szlachetna-czarny mat  
stainless steel-black matt



## Torn

st

index	S	W	H	L	P
Z-5431	3x16	400	28	79	1

P61-G2

czarny mat-chrom połysk  
black matt-glossy chrome

P68-G2

antracyt-chrom połysk  
anthracite-glossy chrome

P68-P61

antracyt-czarny mat  
anthracite-black matt

SS-P61

stal szlachetna-czarny mat  
stainless steel-black matt

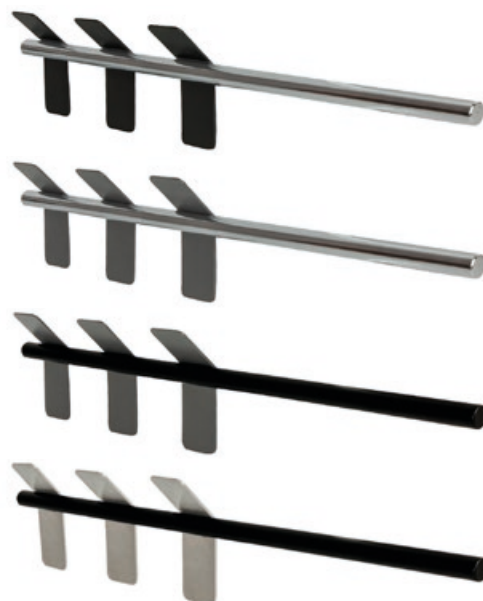



## Torn st

index	S	W	H	L	P
C-6259-32	16	79	28	32	10
C-6259-120	16	79	28	120	10

TL33-TL35  
pastelowy beżowy-pastelowy błękit  
pastel beige-pastel blue

TL35-TL33  
pastelowy błękit-pastelowy beżowy  
pastel blue-pastel beige

TL34-TL36  
pastelowy różowy-pastelowy zielony  
pastel pink-pastel green

TL36-TL34  
pastelowy zielony-pastelowy różowy  
pastel green-pastel pink

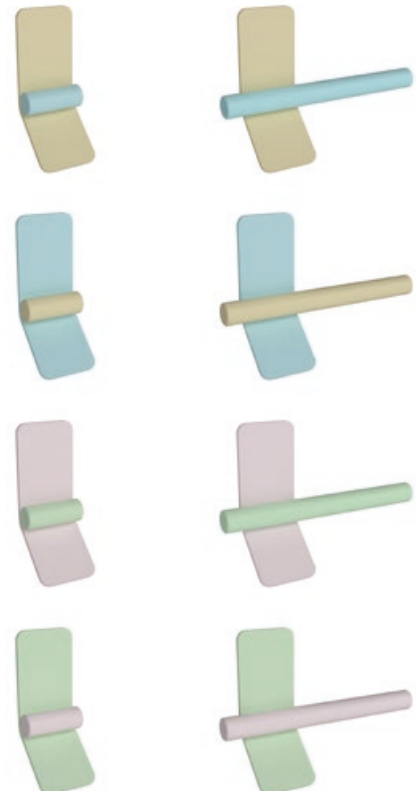





## Torn st

index	S	W	H	L	P
C-6269-32	16	57	34	32	10
C-6269-120	16	57	34	120	10

TL33-TL35  
pastelowy beżowy-pastelowy błękit  
pastel beige-pastel blue

TL35-TL33  
pastelowy błękit-pastelowy beżowy  
pastel blue-pastel beige

TL34-TL36  
pastelowy różowy-pastelowy zielony  
pastel pink-pastel green

TL36-TL34  
pastelowy zielony-pastelowy różowy  
pastel green-pastel pink

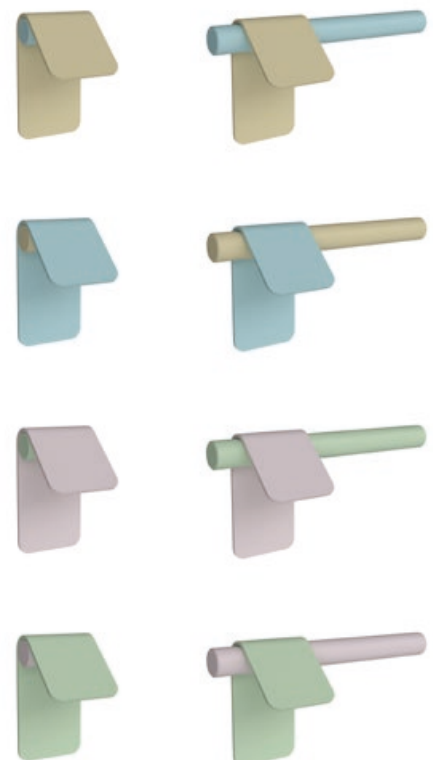



## Torn

st

index	S	W	H	L	P
C-6279-32	16	151	28	32	10

TL33-TL35  
pastelowy beżowy-pastelowy błękit  
pastel beige-pastel blue

TL35-TL33  
pastelowy błękit-pastelowy beżowy  
pastel blue-pastel beige

TL34-TL36  
pastelowy różowy-pastelowy zielony  
pastel pink-pastel green

TL36-TL34  
pastelowy zielony-pastelowy różowy  
pastel green-pastel pink



## Torn

st

index	S	W	H	L	P
Z-5431	3x16	400	28	79	1

TL33-TL35  
pastelowy beżowy-pastelowy błękit  
pastel beige-pastel blue

TL35-TL33  
pastelowy błękit-pastelowy beżowy  
pastel blue-pastel beige

TL34-TL36  
pastelowy różowy-pastelowy zielony  
pastel pink-pastel green

TL36-TL34  
pastelowy zielony-pastelowy różowy  
pastel green-pastel pink

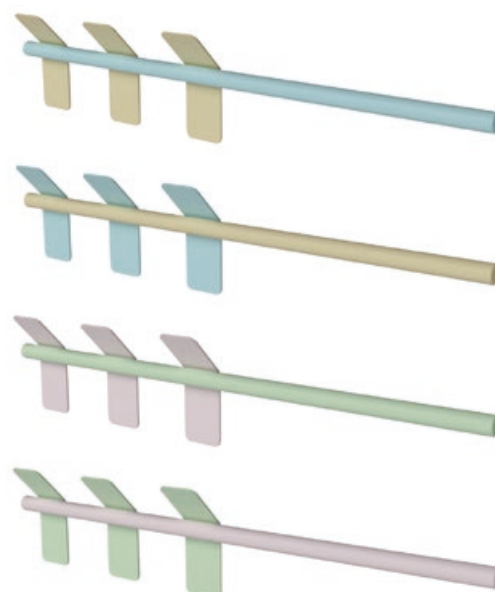





## Lago

złan

index	S	W	H	L	P
Z-5434	16	31	28	56	25

G2  
chrom połysk  
glossy chrome

G8  
stal szlachetna  
stainless steel

G74  
stary mosiądz  
old brass

G77  
złoto matowe czesane  
gold matt brushed

P61  
czarny mat  
black matt

P67  
kość słoniowa  
ivory





## Lago

znal

index	S	W	H	L	P
C-6171	32	56	28	65	25

G2  
chrom połysk  
glossy chrome

G8  
stal szlachetna  
stainless steel

G74  
stary mosiądz  
old brass

G77  
złoto matowe czesane  
gold matt brushed

P61  
czarny mat  
black matt

P67  
kość słoniowa  
ivory



index	S	W	H	L	P
C-6173	96/128	56	28	156	25

G2  
chrom połysk  
glossy chrome

G8  
stal szlachetna  
stainless steel

G74  
stary mosiądz  
old brass

G77  
złoto matowe czesane  
gold matt brushed

P61  
czarny mat  
black matt

P67  
kość słoniowa  
ivory



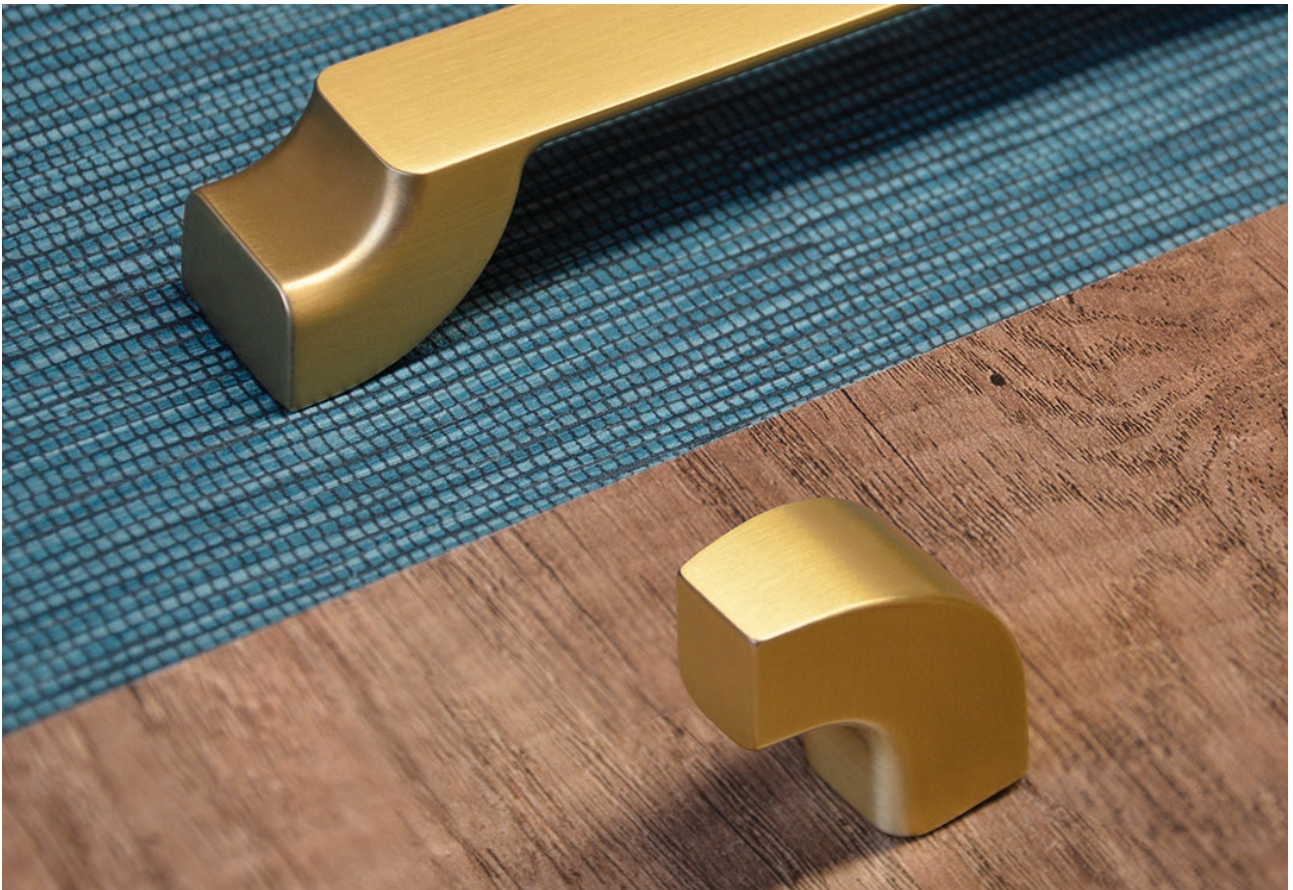



## Solde

znal

index	S	W	H	L	P
A-1572	-	18	36,6	29	25

G2  
chrom połysk  
glossy chrome

G8  
stal szlachetna  
stainless steel

G77  
złoto matowe czesane  
gold matt brushed

P61  
czarny mat  
black matt

P67  
kość słoniowa  
ivory



## Solde

znal

index	S	W	H	L	P
C-5725	160	24	26	170	25
C-5729-320	320	24	26	330	10

G2  
chrom połysk  
glossy chrome

G8  
stal szlachetna  
stainless steel

G77  
złoto matowe czesane  
gold matt brushed

P61  
czarny mat  
black matt

P67  
kość słoniowa  
ivory





# Sid

znał

index	S	W	H	L	P
C-5711	32	12	28	41	25
C-5715	160	12	30	170	25

G2  
chrom połysk  
glossy chrome

G6  
chrom mat  
chrome matt

G49  
cyna postarzana  
old tin

G70  
miedź czesana  
copper brushed

G77  
złoto matowe czesane  
gold matt brushed

P61  
czarny mat  
black matt



index	S	W	H	L	P
Z-5430	-	12	30	65	25

G2  
chrom połysk  
glossy chrome

G6  
chrom mat  
chrome matt

G49  
cyna postarzana  
old tin

G70  
miedź czesana  
copper brushed

G77  
złoto matowe czesane  
gold matt brushed

P61  
czarny mat  
black matt

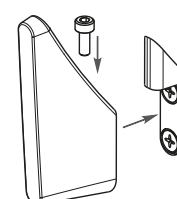



## Aksis

al/znał

index	S	W	H	L	P
A-1522	-	25	30	35	25



index	S	W	H	L	P
C-5039-128	128	25	30	148	25
C-5039-160	160	25	30	180	25
C-5039-192	192	25	30	212	25
C-5039-224	224	25	30	244	25
C-5039-256	256	25	30	276	25
C-5039-320	320	25	30	340	25



A1-G2  
anoda naturalna-chrom połysk  
anodized natural-glossy chrome

G2-G2  
chrom połysk-chrom połysk  
glossy chrome-glossy chrome



## Tavolo

znal

index	S	W	H	L	P
A-1552	-	24	27	26	25



index	S	W	H	L	P
C-5265	160	24	27	184	25

G2  
chrom połysk  
glossy chrome

G49  
cyna postarzana  
old tin

P61  
czarny mat  
black matt





**Salix**  
plst/znal

index	S	W	H	L	P
C-3634	128	18	26	149	25

T1-G2  
biały-chrom połysk  
white-glossy chrome



index	S	W	H	L	P
Z-5415	32	15	39	108	25

T1-G2  
biały-chrom połysk  
white-glossy chrome





## Altare

złot

index	S	W	H	L	P
A-1532	-	25	24	25	25



index	S	W	H	L	P
C-5193	96	25	23	104	25
C-5195	160	25	23	168	25

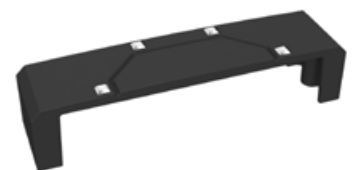

G6  
chrom mat  
chrome matt

G49  
cyna postarzana  
old tin

P61  
czarny mat  
black matt

  
SWAROVSKI



## Caldo

znal

index	S	W	H	L	P
C-5101	32	35	28	40	25
C-5104	128	24	28	135	25

P61  
czarny mat  
black matt

P67  
kość słoniowa  
ivory







## Fiore

znał

index	S	W	H	L	P
C-5111	32	37	29	40	25
C-5114	128	24	29	136	25

P61  
czarny mat  
black matt

P67  
kość słoniowa  
ivory







## Libretto

znal

index	S	W	H	L	P
C-5180	16	16	25	26	25



index	S	W	H	L	P
C-5183	96	22	24	111	25
C-5184	128	22	24	143	25
C-5185	160	22	26	175	25



index	S	W	H	L	P
Z-5421	-	22	28	54	25



G4  
patyna na miedzi  
antique brass

G49  
cyna postarzana  
old tin



## Chorus

znal

index	S	W	H	L	P
C-3052	64	35	25	76	50

G4  
patyna na miedzi  
antique brass

G49  
cyna postarzana  
old tin



index	S	W	H	L	P
Z-5409	32	60	179	68	10

G4  
patyna na miedzi  
antique brass

G49  
cyna postarzana  
old tin





## Leda

znal

index	S	W	H	L	P
B-100	-	34	17	97	100

index	S	W	H	L	P
E-370	-	34	3	97	100

index	S	W	H	L	P
D-062	64	43	17	97	100

G4  
patyna na miedzi  
antique brass







## Sparta

znal

index	S	W	H	L	P
A-1434	-	38	23	-	25

index	S	W	H	L	P
C-3264	128	38	23	155	25

index	S	W	H	L	P
Z-5413	32	42	59	174	25

G4  
patyna na miedzi  
antique brass

G35  
srebro postarzone  
old silver







# Campana

znał

index	S	W	H	L	P
C-5821	32	8,5	28	51	25
C-5823	96	8,5	28	114	50
C-5824	128	8,5	28	146	50
C-5825	160	8,5	28	178	25
C-5826	192	8,5	28	210	25
C-5828	256	8,5	28	274	25
C-5829-320	320	8,5	28	338	25
C-5829-416	416	8,5	28	434	25

G2

chrom połysk  
glossy chrome

G3

złoty połysk  
glossy gold

G5

nikiel mat  
nickel matt

G6

chrom mat  
chrome matt

G8

stal szlachetna  
stainless steel

G10A

patyna na miedzi czesana na krawędziach  
black nickel on brass brushed on edges

G20A

patyna na miedzi czesana na krawędziach  
black nickel on copper brushed on edges

G49

cyna postarzana  
old tin

G70

miedź czesana  
copper brushed

G77

złoto matowe czesane  
gold matt brushed

P59

czarny połysk  
glossy black

P60

biały połysk  
glossy white

P61

czarny mat  
black matt

P68

antracyt  
anthracite







index	W	H	P
A-1602	25	17	20

- G2  
chrom połysk  
glossy chrome
- G3  
złoty połysk  
glossy gold
- G5  
nikiel mat  
nickel matt
- G6  
chrom mat  
chrome matt
- G10A  
patyna na miedzi czesana na krawędziach  
black nickel on brass brushed on edges
- G20A  
patyna na miedzi czesana na krawędziach  
black nickel on copper brushed on edges
- G49  
cyna postarzana  
old tin
- G70  
miedź czesana  
copper brushed
- G77  
złoto matowe czesane  
gold matt brushed
- P59  
czarny połysk  
glossy black
- P60  
biały połysk  
glossy white
- P61  
czarny mat  
black matt
- P68  
antracyt  
anthracite

## Campana

znal







uchwyty / handles

## Prato

st

index	S	W	H	L	P
C-6193	96	44	39	136	10
C-6195	160	44	39	200	10

G73  
stara miedź  
old copper

P61  
czarny mat  
black matt

P68  
antracyt  
anthracite

SS  
stal szlachetna  
stainless steel



## Prato ażurowe symetryczne Prato openwork symmetric

st

index	S	W	H	L	P
C-6483	96	44	39	136	10
C-6485	160	44	39	200	10
C-6489-320	320	39	360	10	

P61  
czarny mat  
black matt

P67  
kość słoniowa  
ivory

P68  
antracyt  
anthracite





## Prato ażurowe asymetryczne Prato openwork unsymmetric

st

index	S	W	H	L	P
C-6493	96	44	39	136	10
C-6495	160	44	39	200	10
C-6499-320	320	44	39	360	10

P61  
czarny mat  
black matt

P67  
kość słoniowa  
ivory

P68  
antracyt  
anthracite







## Ondin

al/znal

index	S	W	H	L	P
C-6729-192RA2	192	30	32	272	10
C-6729-320RA2	320	30	32	400	10

A10-TL77  
anoda czarna-złoto matowe  
anodized black-gold matt

A10-P61  
anoda czarna-czarny mat  
anodized black-black matt

A2-TL77  
anoda złota-złoto matowe  
anodized gold-gold matt



## Cert

al/znal

index	S	W	H	L	P
C-6739-192	192	30	32	272	10
C-6739-320	320	30	32	400	10

A10-TL77  
anoda czarna-złoto matowe  
anodized black-gold matt

A10-P61  
anoda czarna-czarny mat  
anodized black-black matt

A2-TL77  
anoda złota-złoto matowe  
anodized gold-gold matt





## Natale

st/znał

index	S	W	H	L	P
C-6219-160	160	12	36	171	10
C-6219-192	192	12	36	203	10
C-6219-320	320	12	36	331	10



G72-G2  
tytan-chrom połysk  
titanium-glossy chrome

P61-G2  
czarny mat-chrom połysk  
black matt-glossy chrome

G72-G72  
tytan-tytan  
titanium-titanium

P61-G77  
czarny mat-złoto matowe czesane  
black matt-gold matt brushed



## Natale

al/znał

index	S	W	H	L	P
C-6219-160RA1	160	12	36	171	10
C-6219-192RA1	192	12	36	203	10
C-6219-320RA1	320	12	36	331	10

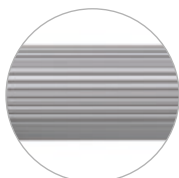

A1-G2  
anoda naturalna-chrom połysk  
anodized natural-glossy chrome

A10-G2  
anoda czarna-chrom połysk  
anodized black-glossy chrome

A10-G72  
anoda czarna-tytan  
anodized black-titanium

A10-G77  
anoda czarna-złoto matowe czesane  
anodized black-gold matt brushed



## Natale

al/znał

index	S	W	H	L	P
C-6219-160RA2	160	12	36	171	10
C-6219-192RA2	192	12	36	203	10
C-6219-320RA2	320	12	36	331	10

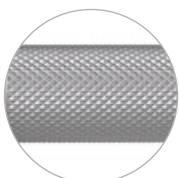

A1-G2  
anoda naturalna-chrom połysk  
anodized natural-glossy chrome

A10-G2  
anoda czarna-chrom połysk  
anodized black-glossy chrome

A10-G72  
anoda czarna-tytan  
anodized black-titanium

A10-G77  
anoda czarna-złoto matowe czesane  
anodized black-gold matt brushed





## Alambre

st/znał

index	S	W	H	L	P
C-6229-160	160	12	36	181	10
C-6229-192	192	12	36	213	10
C-6229-320	320	12	36	341	10

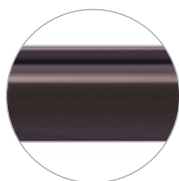

G72-G2  
tytan-chrom połysk  
titanium-glossy chrome

P61-G2  
czarny mat-chrom połysk  
black matt-glossy chrome

G72-G72  
tytan-tytan  
titanium-titanium

P61-G77  
czarny mat-złoto matowe czesane  
black matt-gold matt brushed



## Alambre

al/znał

index	S	W	H	L	P
C-6229-160RA1	160	12	36	181	10
C-6229-192RA1	192	12	36	213	10
C-6229-320RA1	320	12	36	341	10

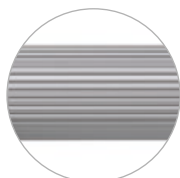

A1-G2  
anoda naturalna-chrom połysk  
anodized natural-glossy chrome

A10-G2  
anoda czarna-chrom połysk  
anodized black-glossy chrome

A10-G72  
anoda czarna-tytan  
anodized black-titanium

A10-G77  
anoda czarna-złoto matowe zesane  
anodized black-gold matt brushed



## Alambre

al/znał

index	S	W	H	L	P
C-6229-160RA2	160	12	36	181	10
C-6229-192RA2	192	12	36	213	10
C-6229-320RA2	320	12	36	341	10

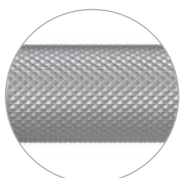

A1-G2  
anoda naturalna-chrom połysk  
anodized natural-glossy chrome

A10-G2  
anoda czarna-chrom połysk  
anodized black-glossy chrome

A10-G72  
anoda czarna-tytan  
anodized black-titanium

A10-G77  
anoda czarna-złoto matowe zesane  
anodized black-gold matt brushed





## Tiara

st/znał

index	S	W	H	L	P
C-6239-192	192	12	36	204	10
C-6239-320	320	12	36	332	10

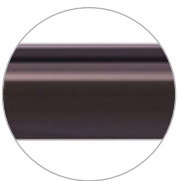

P61-G2  
czarny mat-chrom połysk  
black matt-glossy chrome

G72-G2  
tytan-chrom połysk  
titanium-glossy chrome

G72-G72  
tytan-tytan  
titanium-titanium

P61-G77  
czarny mat-złoto matowe czesane  
black matt-gold matt brushed



## Tiara

al/znał

index	S	W	H	L	P
C-6239-192RA1	192	12	36	204	10
C-6239-320RA1	320	12	36	332	10



A1-G2  
anoda naturalna-chrom połysk  
anodized natural-glossy chrome

A10-G2  
anoda czarna-chrom połysk  
anodized black-glossy chrome

A10-G72  
anoda czarna-tytan  
anodized black-titanium

A10-G77  
anoda czarna-złoto matowe czesane  
anodized black-gold matt brushed



## Tiara

al/znał

index	S	W	H	L	P
C-6239-192RA2	192	12	36	204	10
C-6239-320RA2	320	12	36	332	10

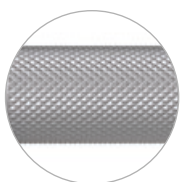

A1-G2  
anoda naturalna-chrom połysk  
anodized natural-glossy chrome

A10-G2  
anoda czarna-chrom połysk  
anodized black-glossy chrome

A10-G72  
anoda czarna-tytan  
anodized black-titanium

A10-G77  
anoda czarna-złoto matowe czesane  
anodized black-gold matt brushed





Remo

st/znał

index	S	W	H	L	P
C-6249-192	192	12	36	262	10
C-6249-320	320	12	36	390	10

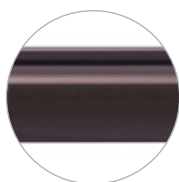

P61-G2  
czarny mat-chrom połysk  
black matt-glossy chrome

G72-G2  
tytan-chrom połysk  
titanium-glossy chrome

G72-G72  
tytan-tytan  
titanium-titanium

P61-G77  
czarny mat-złoto matowe czesane  
black matt-gold matt brushed





## Remo

al/znał

index	S	W	H	L	P
C-6249-192RA1	192	12	36	262	10
C-6249-320RA1	320	12	36	390	10

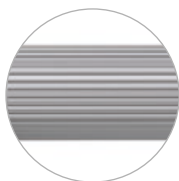

A1-G2  
anoda naturalna-chrom połysk  
anodized natural-glossy chrome

A10-G2  
anoda czarna-chrom połysk  
anodized black-glossy chrome

A10-G72  
anoda czarna-tytan  
anodized black-titanium

A10-G77  
anoda czarna-złoto matowe czesane  
anodized black-gold matt brushed



## Remo

al/znał

index	S	W	H	L	P
C-6249-192RA2	192	12	36	262	10
C-6249-320RA2	320	12	36	390	10

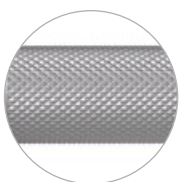

A1-G2  
anoda naturalna-chrom połysk  
anodized natural-glossy chrome

A10-G2  
anoda czarna-chrom połysk  
anodized black-glossy chrome

A10-G72  
anoda czarna-tytan  
anodized black-titanium

A10-G77  
anoda czarna-złoto matowe czesane  
anodized black-gold matt brushed







## Cruso

al/znał

index	S	W	H	L	P
C-2100-188RA2	128	12	32	188	10
C-2100-220RA2	160	12	32	220	10
C-2100-272RA2	192	12	32	272	10
C-2100-400RA2	320	12	32	400	10

G2-G2  
chrom połysk-chrom połysk  
glossy chrome-glossy chrome

G3-G3  
złoty połysk-złoty połysk  
glossy gold-glossy gold

A10-P61  
anoda czarna-czarny mat  
anodized black -black matt





## Dublin

znal

index	S	W	H	L	P
C-3014N	128	15	25	143	25
C-3015N	160	15	25	175	25

G4  
patyna na mosiądzu  
antique brass

G49  
cyna postarzana  
old tin

P61  
czarny mat  
black matt





## Hermes

st/znał

index	S	W	H	L	P
C-6515	160	13	32	173	25
C-6516	192	13	32	205	25
C-6519-320	320	13	32	333	25

P61-G2  
czarny mat-chrom połysk  
black matt-glossy chrome

P61-TL77  
czarny mat-złoto matowe  
black matt-gold matt

P61-P61  
czarny mat-czarny mat  
black matt-black matt



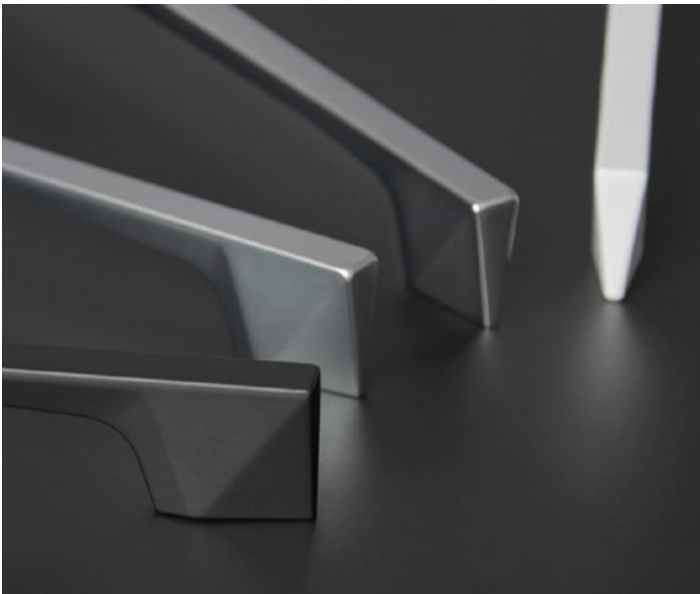

## Linea

znał

index	S	W	H	L	P
C-6476	192	10	28	235	25
C-6479-320	320	10	28	362	25

G2  
chrom połysk  
glossy chrome

G6  
chrom mat  
chrome matt

P61  
czarny mat  
black matt

P67  
kość słoniowa  
ivory





## Enzo

al

index	S	W	H	L	P
C-5849-160	160	12	30	177	10
C-5849-192	192	12	30	209	10
C-5849-256	256	12	30	273	10
C-5849-320	320	12	30	337	10

A1  
anoda naturalna  
anodized natural

G2  
chrom połysk  
glossy chrome

P61  
czarny mat  
black matt









## Apro

al

index	S	W	H	L	P
C-5769-394/352	352	12	35	394	10
C-5769-522/352	352/480	12	35	522	10

A1  
anoda naturalna  
anodized natural

A2  
anoda złota  
anodized gold

G2  
chrom połysk  
glossy chrome

G3  
złoty połysk  
glossy gold

P61  
czarny mat  
black matt



index	S	W	H	L	P
C-3159-398	398/462	13	30	500	10



index	S	W	H	L	P
C-3159A-1024	1024(2x512)/1088	13	30	1126	1



index	S	W	H	L	P
C-3159B-1024	1024(672+352)/1088	13	30	1126	1



G2-G2  
chrom połysk-chrom połysk  
glossy chrome-glossy chrome

A10-P61  
anoda czarna-czarny mat  
anodized black-black matt



## Arno

al/znał

index	S	W	H	L	P
C-6759-416RA1	416	22	45	496	1



index	S	W	H	L	P
C-6759-1056RA1	1056	22	45	1136	1

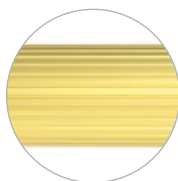

G3-G3  
złoty połysk-złoty połysk  
glossy gold-glossy gold

A2-TL77  
anoda złota-złoto matowe  
anodized gold-gold matt

A10-P61  
anoda czarna-czarny mat  
anodized black-black matt

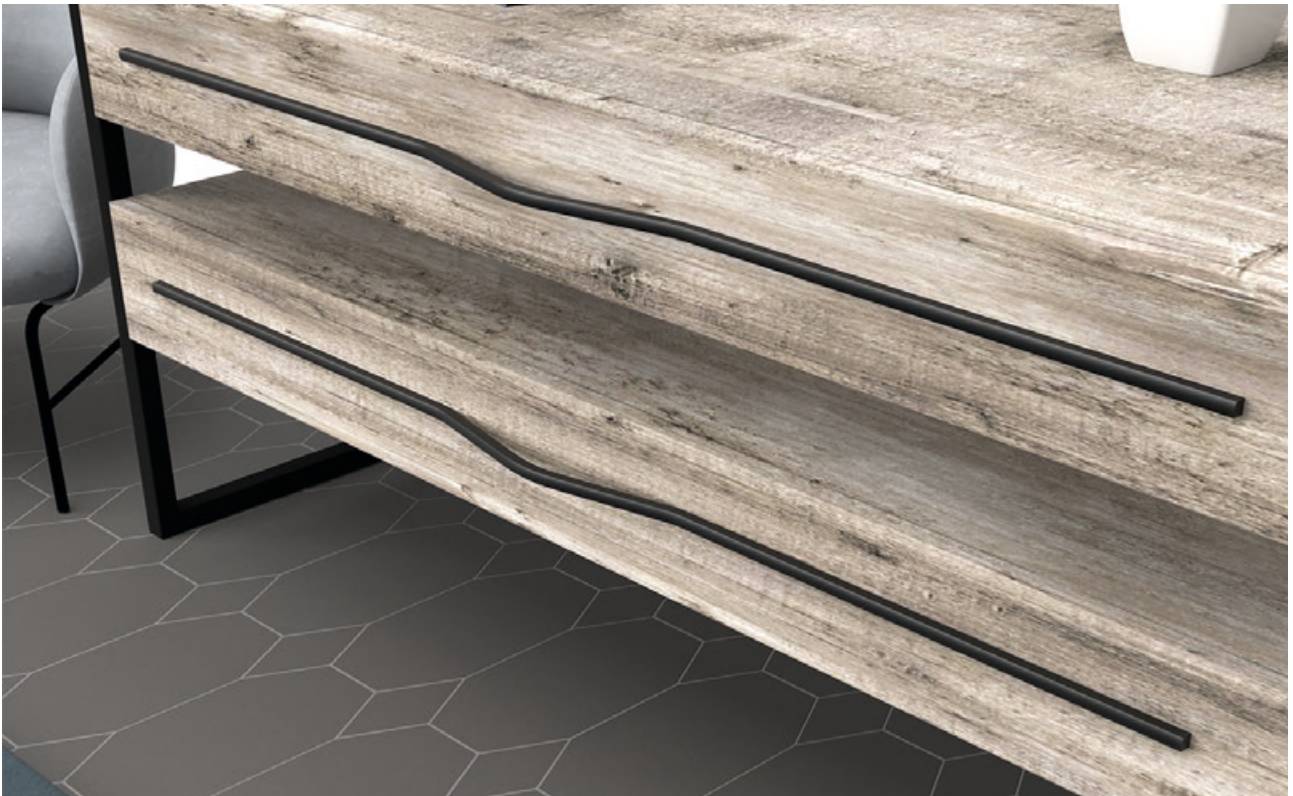

index	S	W	H	L	P	A	B
C-5769-1135/352	352/1056	12	35	1135	5	352	1056

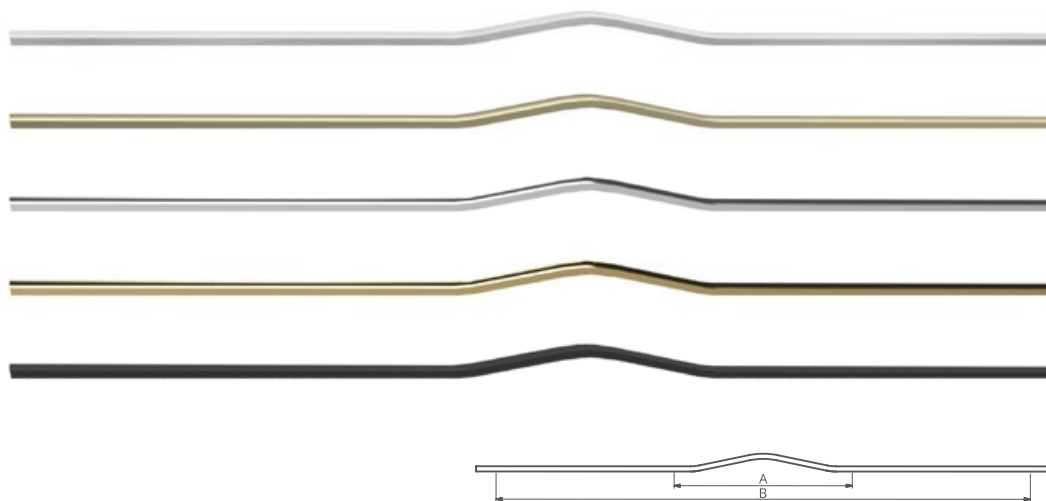

index	S	W	H	L	P	A	B	C	D
C-5769-1135A/352	352/1056	12	35	1135	5	21	64	352	640

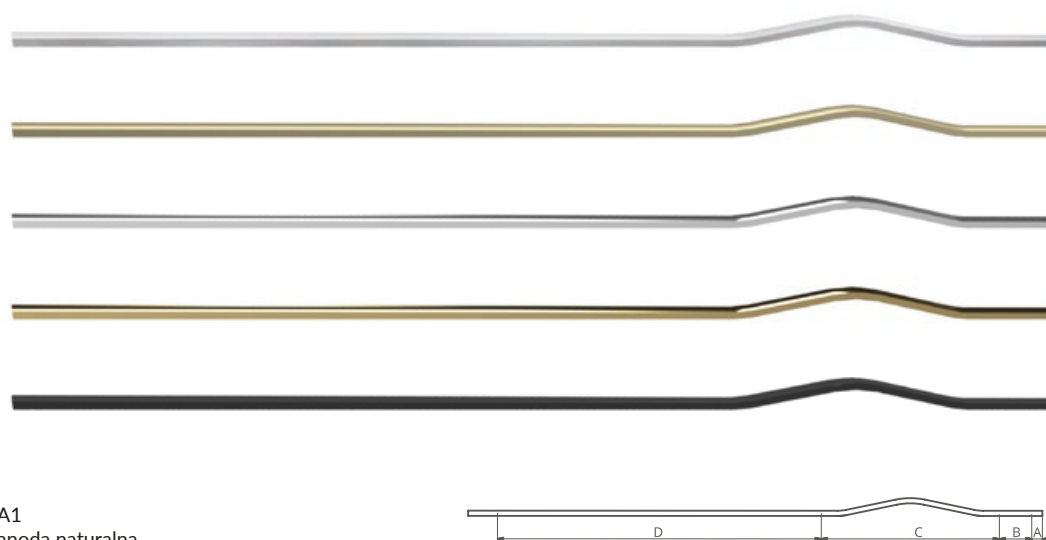

A1  
anoda naturalna  
anodized natural

A2  
anoda złota  
anodized gold

G2  
chrom połysk  
glossy chrome

G3  
złoty połysk  
glossy gold

P61  
czarny mat  
black matt



index	S	W	H	L	P	A	B	C
C-5439-1028/1135	1028	8	30	1135	10	8,5	256	772

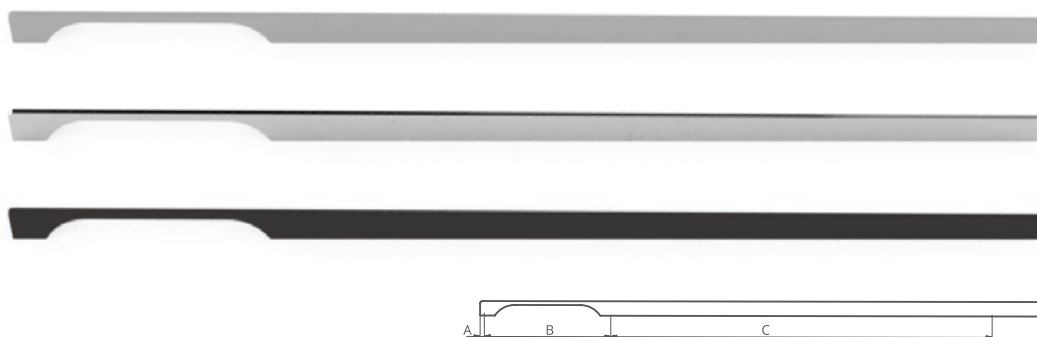

index	S	W	H	L	P	A	B
C-5439-1024/1135A	832/1024	8	30	1135	10	832	1024

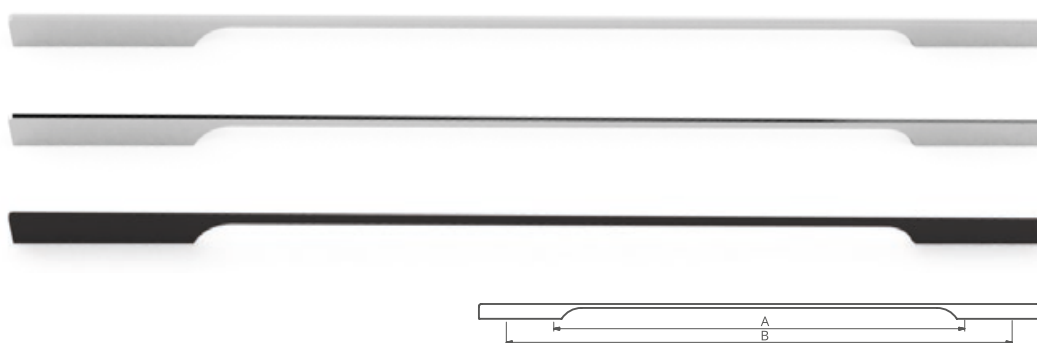

index	S	W	H	L	P	A	B
C-5579-1024/1135	512/1024	8	30	1135	10	512	1024

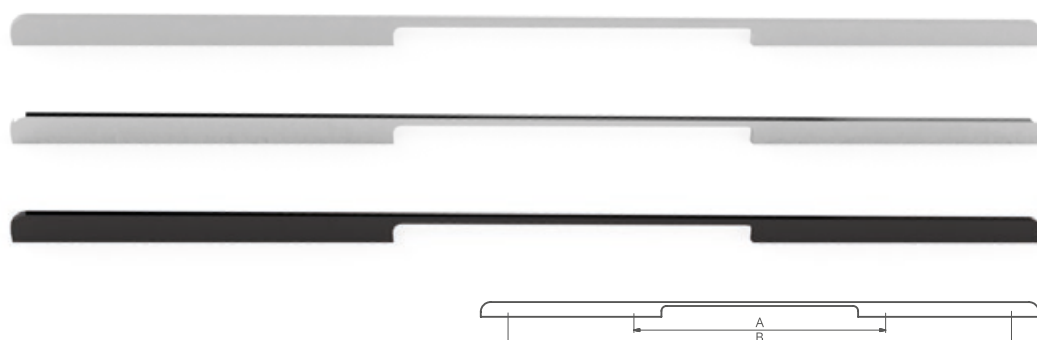

A1  
anoda naturalna  
anodized natural

G2  
chrom połysk  
glossy chrome

P61  
czarny mat  
black matt



## Preso

znal

index	S	W	H	L	P
C-5705	160	19,5	27	169	25

G2  
chrom połysk  
glossy chrome

G6  
chrom mat  
chrome matt

G8  
stal szlachetna  
stainless steel

G49  
cyna postarzana  
old tin





## Andora

znal

index	S	W	H	L	P
C-1654	128	19	27	160	50
C-1655	160	20	28	194	50

G49  
cyna postarzana  
old tin

P61  
czarny mat  
black matt



## Ferro

znal

index	S	W	H	L	P
C-5923	96	18	24	144	25
C-5929-320	320	18	24	368	10

G2  
chrom połysk  
glossy chrome

G8  
stal szlachetna  
stainless steel

P61  
czarny mat  
black matt





## Wood

znal

index	S	W	H	L	P
C-5634	128	20	26	168	25

G10M  
patyna na miedzi  
antique brass

G20M  
patyna na miedzi  
antique copper

P67  
kość słoniowa  
ivory

P68  
antracyt  
anthracite





## Letto

znal

index	S	W	H	L	P
C-5065	160	11	34	203	25
C-5069-320	320	11	34	363	25

G2  
chrom połysk  
glossy chrome

G6  
chrom mat  
chrome matt

G8  
stal szlachetna  
stainless steel

G77  
złoto matowe czesane  
gold matt brushed





## Galium

al/znał

index	S	W	H	L	P
C-094RA2	128	10	30	158	10
C-095RA2	160	10	30	190	10
C-096RA2	192	10	30	222	10
C-099-320RA2	320	10	30	330	10

A10-G2  
anoda czarna-chrom połysk  
anodized black-glossy chrome

A8-G6  
stal szlachetna-chrom mat  
stainless steel-chrome matt

G4-G4  
patyna na mosiądzu-patyna na mosiądzu  
antique brass-antique brass







## Galium

st/znał

index	S	W	H	L	P
C-094ST	128	14	30	158	25
C-095ST	160	14	30	190	25
C-096ST	192	14	30	222	25
C-099-320ST	320	14	30	350	25

G2-G2  
chrom połysk-chrom połysk  
glossy chrome-glossy chrome

G3-G3  
złoty połysk-złoty połysk  
glossy gold-glossy gold

G4-G4  
patyna na miedzi-patyna na miedzi  
antique brass-antique brass

G8-G2  
stal szlachetna-chrom połysk  
stainless steel-glossy chrome

P60-G2  
biały połysk-chrom połysk  
glossy white-glossy chrome





## Viva

al/znał

index	S	W	H	L	P
C-4509-128	128	10	18	146	25
C-4509-160	160	10	18	178	25
C-4509-192	192	10	18	221	25
C-4509-320	320	10	18	338	25

P59-G2  
czarny połysk-chrom połysk  
glossy black-glossy chrome

P60-G2  
biały połysk-chrom połysk  
glossy white-glossy chrome





## Pero

al/znał

index	S	W	H	L	P
C-5149-160	160	12	30	180	25
C-5149-256	256	12	30	276	25
C-5149-320	320	12	30	340	25

P59-G2  
czarny połysk-chrom połysk  
glossy black-glossy chrome

P60-G2  
biały połysk-chrom połysk  
glossy white-glossy chrome



## Pablo

al/znał

index	S	W	H	L	P
C-5509-128	128	12	30	140	25
C-5509-160	160	12	30	172	25
C-5509-192	192	12	30	204	25
C-5509-320	320	12	30	332	25

P60-G2  
biały połysk-chrom połysk  
glossy white-glossy chrome

P61-G2  
czarny mat-chrom połysk  
black matt-glossy chrome







## Prestige

al/znał

index	S	W	H	L	P
C-4429-128	128	12	38	140	25
C-4429-160	160	12	38	172	25
C-4429-192	192	12	38	204	25
C-4429-320	320	12	38	332	25

A11-G2  
anoda szczotkowana-chrom połysk  
anodized brushed-glossy chrome

P59-G2  
czarny połysk-chrom połysk  
glossy black-glossy chrome

P60-G2  
biały połysk-chrom połysk  
glossy white-glossy chrome



## Lavice

al/znal

index	S	W	H	L	P
C-3809-128	128	18	29	146	25
C-3809-160	160	18	29	178	25
C-3809-192	192	18	29	210	25
C-3809-224	224	18	29	242	25
C-3809-256	256	18	29	274	25
C-3809-320	320	18	29	338	25
C-3809-384	384	18	29	402	25

A1-G6  
anoda naturalna-chrom mat  
anodized natural-chrome matt

G2-G2  
chrom połysk-chrom połysk  
glossy chrome-glossy chrome



## Encato

al/znal

index	S	W	H	L	P
C-4409-128	128	24	29	136	25
C-4409-160	160	24	29	168	25
C-4409-192	192	24	29	200	25
C-4409-320	320	24	29	328	25

A1-G2  
anoda naturalna-chrom połysk  
anodized natural-glossy chrome

A11-G2  
anoda szczotkowana-chrom połysk  
anodized brushed-glossy chrome

P59-G2  
czarny połysk-chrom połysk  
glossy black-glossy chrome

P60-G2  
biały połysk-chrom połysk  
glossy white-glossy chrome



## Fresco

al/znał

index	S	W	H	L	P
C-4469-128	128	18	28	165	25
C-4469-160	160	18	31	197	25
C-4469-192	192	18	33	229	25
C-4469-320	320	18	35	357	25

A1-G2  
anoda naturalna-chrom połysk  
anodized natural-glossy chrome

A11-G2  
anoda szczotkowana-chrom połysk  
anodized brushed-glossy chrome

P59-G2  
czarny połysk-chrom połysk  
glossy black-glossy chrome

P60-G2  
biały połysk-chrom połysk  
glossy white-glossy chrome



## Vigor

al/znał

index	S	W	H	L	P
C-4189-128	128	24	29	136	25
C-4189-160	160	24	29	168	25
C-4189-192	192	24	29	200	25
C-4189-320	320	24	29	328	25

A1-G2  
anoda naturalna-chrom połysk  
anodized natural-glossy chrome

A11-G2  
anoda szczotkowana-chrom połysk  
anodized brushed-glossy chrome

P59-G2  
czarny połysk-chrom połysk  
glossy black-glossy chrome

P60-G2  
biały połysk-chrom połysk  
glossy white-glossy chrome





index	S	W	H	L	P
C-5455	160	18	34	170	25
C-5458	256	18	34	266	25
C-5459-320	320	18	34	330	25

G8-G2  
stal szlachetna-chrom połysk  
stainless steel-glossy chrome

TL20-P59  
miedź-czarny połysk  
cop-glossy black

P59-TL20  
czarny połysk-miedź  
glossy black-copper

G2-P59  
chrom połysk-czarny połysk  
glossy chrome-glossy black

P59-G2  
czarny połysk-chrom połysk  
glossy black-glossy chrome

G2-P60  
chrom połysk-biały połysk  
glossy chrome-glossy white

P60-G2  
biały połysk-chrom połysk  
glossy white-glossy chrome

P59-P60  
czarny połysk-biały połysk  
glossy black-glossy white

P60-P59  
biały połysk-czarny połysk  
glossy white-glossy black



## Aris

znal

index	S	W	H	L	P
C-4519Z-128	128	12	22	148	25

G2  
chrom połysk  
glossy chrome

G6  
chrom mat  
chrome matt

G8  
stal szlachetna  
stainless steel



## Fivela

znal

index	S	W	H	L	P
C-4005	128/160	10	30	230	25

G2  
chrom połysk  
glossy chrome



## Teres

znal

index	S	W	H	L	P
C-4565	160	22	26	276	25

G2  
chrom połysk  
glossy chrome



## Asser

znal

index	S	W	H	L	P
C-3314	128	31	31	135	25
C-3318	256	31	31	263	25

G2  
chrom połysk  
glossy chrome





## Ashema

znał

index	S	W	H	L	P
C-192	64	27	20	94	50

G2  
chrom połysk  
glossy chrome

G4  
patyna na miedzi  
antique brass

P61  
czarny mat  
black matt







## Rene

znal

index	S	W	H	L	P
D-033	96	45	17	125	100

G71  
stary nikiel  
old nickel



## Virtus

znal

index	S	W	H	L	P
D-168	96	50	19	126	100

G71  
stary nikiel  
old nickel



## Rahim

znal

index	S	W	H	L	P
D-023	96	41	18	119	100

G71  
stary nikiel  
old nickel





Clio

znal

index	S	W	H	L	P
C-1973	96	24	26	140	100

G4  
patyna na miedzi  
antique brass

G49  
cyna postarzana  
old tin

P61  
czarny mat  
black matt



## Kronos

znal

index	S	W	H	L	P
C-293	96	14	24	135	100

G4  
patyna na miedzi  
antique brass



## Nyja

znal

index	S	W	H	L	P
C-1983	96	16	28	112	100

G4  
patyna na miedzi  
antique brass

G49  
cyna postarzana  
old tin



## Cerber

znal

index	S	W	H	L	P
C-1553	96	16	32	114	100

G4  
patyna na miedzi  
antique brass

G49  
cyna postarzana  
old tin





## Ansa

plst/znal

index	S	W	H	L	P
C-3444	128	25	33	169	100

T41-G4  
kość słoniowa-patyna na mosiądzu  
ivory-antique brass



## Bachus

znal

index	S	W	H	L	P
C-1003	96	15	29	111	100

G4  
patyna na mosiądzu  
antique brass

P61  
czarny mat  
black matt



## Zeus

znal

index	S	W	H	L	P
C-2943	96	23	24	150	100

G4  
patyna na mosiądzu  
antique brass

G49  
cyna postarzana  
old tin





## Torre

złot

index	S	W	H	L	P
C-5834	128	11	28	145	25
C-5836	192	11	28	209	25
C-5838	256	11	28	273	25
C-5839-320	320	11	28	337	25

G2  
chrom połysk  
glossy chrome

G6  
chrom mat  
chrome matt

G8  
stal szlachetna  
stainless steel

G77  
złoto matowe czesane  
gold matt brushed

P60  
biały połysk  
glossy white

P61  
czarny mat  
black matt



## Fede

znal

index	S	W	H	L	P
C-5275	160	9	35	178	25

G2  
chrom połysk  
glossy chrome

G6  
chrom mat  
chrome matt

G70  
miedź czesana  
copper brushed

P61  
czarny mat  
black matt



## Rotto

znal

index	S	W	H	L	P
C-5875Z	160	22	25	180	25

G5  
nikiel mat  
nickel matt

G6  
chrom mat  
chrome matt

P60  
biały połysk  
glossy white

P61  
czarny mat  
black matt







## Noak

złot

index	S	W	H	L	P
C-4484	128	15	32	145	50
C-4485	160	15	32	177	50
C-4486	192	15	32	209	50
C-4489-320	320	15	32	337	25

G2  
chrom połysk  
glossy chrome

G5  
nikiel mat  
nickel matt

G6  
chrom mat  
chrome matt

G8  
stal szlachetna  
stainless steel



## Enel

złot

index	S	W	H	L	P
C-4474	128	14	33	149	50
C-4475	160	15	37	183	50
C-4476	192	15	37	219	50
C-4478	256	15	37	293	50

G2  
chrom połysk  
glossy chrome

G5  
nikiel mat  
nickel matt

G6  
chrom mat  
chrome matt

G8  
stal szlachetna  
stainless steel





Verne

znal

index	S	W	H	L	P
C-5074	128	20	26	168	25
C-5075	160	20	28	200	25

G2  
chrom połysk  
glossy chrome

G4  
patyna na miedzi  
antique brass

G49  
cyna postarzana  
old tin

P61  
czarny mat  
black matt



## Libro

złot

index	S	W	H	L	P
C-5053	96	12	25	134	25
C-5055	160	14	27	198	25

G2  
chrom połysk  
glossy chrome

G6  
chrom mat  
chrome matt

G8  
stal szlachetna  
stainless steel



## Vea

złot

index	S	W	H	L	P
C-4495	160	23	29	182	25
C-4498	256	23	29	278	25

G2  
chrom połysk  
glossy chrome

G6  
chrom mat  
chrome matt

G77  
złoto matowe czesane  
gold matt brushed

P68  
antracyt  
anthracite





## Songo

znal

index	S	W	H	L	P
C-3484	128	20	25	145	50
C-3485	160	20	26	177	50
C-3486	192	22	27	209	50
C-3488	256	23	27	273	50
C-3489-320	320	26	29	337	25

G2  
chrom połysk  
glossy chrome

G6  
chrom mat  
chrome matt

G8  
stal szlachetna  
stainless steel

P61  
czarny mat  
black matt

P68  
antracyt  
anthracite





## Alternative

znal

index	S	W	H	L	P
C-3274	128	10	31	192	50
C-3278	256	10	31	318	25

G2  
chrom połysk  
glossy chrome

G5  
nikiel mat  
nickel matt

G6  
chrom mat  
chrome matt

G8  
stal szlachetna  
stainless steel





## Rustico

znal

index	S	W	H	L	P
C-3814	128	16	27	150	50
C-3815	160	16	29	182	50
C-3816	192	16	29	214	50
C-3818	256	19	30	299	50
C-3819-320	320	20	31	363	25

G2  
chrom połysk  
glossy chrome

G6  
chrom mat  
chrome matt

G8  
stal szlachetna  
stainless steel





## Fibbia

znal

index	S	W	H	L	P
C-3824	128	14	30	173	50
C-3825	160	15	32	209	50
C-3826	192	15	32	241	50
C-3827	224	15	32	273	50
C-3828	256	15	32	302	50
C-3829-320A	320	15	32	366	25

G2  
chrom połysk  
glossy chrome

G5  
nikiel mat  
nickel matt

G8  
stal szlachetna  
stainless steel



## Pectus

znal

index	S	W	H	L	P
C-4414	128	8	29	165	50
C-4415	160	8	33	207	50
C-4419-320	320	8	37	337	25

G2  
chrom połysk  
glossy chrome

G6  
chrom mat  
chrome matt





## Golden Gate

znał

index	S	W	H	L	P
C-3475	160	18	26	228	50
C-3479-320	320	18	26	388	25

G2  
chrom połysk  
glossy chrome

G6  
chrom mat  
chrome matt

G8  
stal szlachetna  
stainless steel





## Ordo

znal

index	S	W	H	L	P
C-4435	160	10	28	183	25

G2  
chrom połysk  
glossy chrome

G4  
patyna na mosiądzu  
antique brass

G6  
chrom mat  
chrome matt

P61  
czarny mat  
black matt



## Armado

znal

index	S	W	H	L	P
C-5305	160	14	35	179	25

G2  
chrom połysk  
glossy chrome

G6  
chrom mat  
chrome matt

G49  
cyna postarzana  
old tin

P61  
czarny mat  
black matt



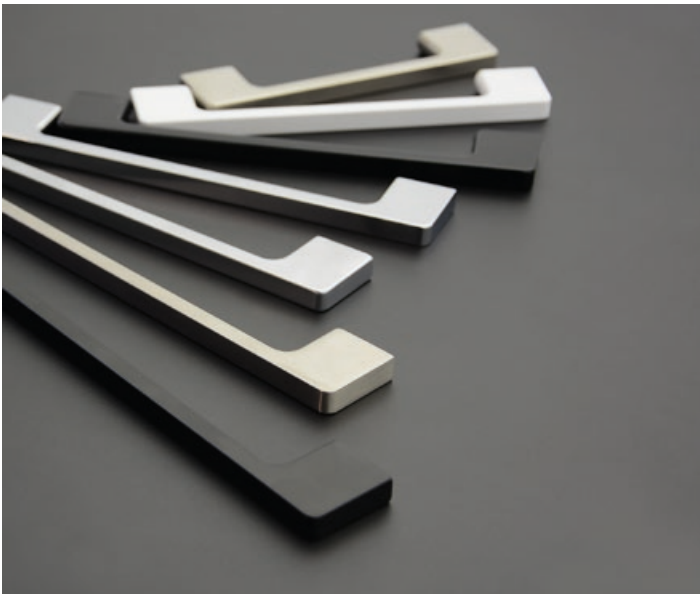

## Techno

znal

index	S	W	H	L	P
C-1143	96	9	30	137	50
C-1144	128	9	30	169	50
C-1145	160	9	30	187	25
C-1146	160/192	9	30	204	25
C-1148	256	9	30	268	25
C-1149-320	320	9	30	332	25

G2  
chrom połysk  
glossy chrome

G5  
nikiel mat  
nickel matt

G6  
chrom mat  
chrome matt

G8  
stal szlachetna  
stainless steel

P59  
czarny połysk  
glossy black

P60  
biały połysk  
glossy white

P61  
czarny mat  
black matt





## House

znał

index	S	W	H	L	P
C-2951	32	8	34	55	25
C-2954	128	8	34	151	50
C-2955	160	8	34	183	50
C-2957	224	8	34	247	50
C-2958	256	8	34	279	50
C-2959-320	320	8	34	343	25

G2  
chrom połysk  
glossy chrome

G5  
nikiel mat  
nickel matt

G6  
chrom mat  
chrome matt

G8  
stal szlachetna  
stainless steel





## Left Field

znal

index	S	W	H	L	P
C-3147	224	8	32	250	25

G2  
chrom potysk  
glossy chrome

G5  
nikiel mat  
nickel matt

G6  
chrom mat  
chrome matt

G8  
stal szlachetna  
stainless steel



## Fuga

znal

index	S	W	H	L	P
C-3135	128/160	8	32	215	50
C-3137	224	8	32	250	25

G2  
chrom potysk  
glossy chrome

G5  
nikiel mat  
nickel matt

G6  
chrom mat  
chrome matt

G8  
stal szlachetna  
stainless steel





## Frotto

znał

index	S	W	H	L	P
C-3839Z-128	128	7	25	144	50
C-3839Z-160	160	7	25	176	50
C-3839Z-192	192	7	25	208	50
C-3839Z-224	224	7	25	240	50
C-3839Z-320	320	7	25	336	25
C-3839Z-416/450	288/416	7	25	450	25

G2  
chrom połysk  
glossy chrome

G6  
chrom mat  
chrome matt

P59  
czarny połysk  
glossy black

P60  
biały połysk  
glossy white



## Pronus

znal

index	S	W	H	L	P
C-4089Z-96	96	7	25	120	50
C-4089Z-128	128	7	25	152	50
C-4089Z-160	160	7	25	184	50
C-4089Z-192	192	7	25	216	50
C-4089Z-320	320	7	25	344	25

G2  
chrom połysk  
glossy chrome

G6  
chrom mat  
chrome matt



## Baleno

znal

index	S	W	H	L	P
C-5324	128	9	17	158	50

G2  
chrom połysk  
glossy chrome

G5  
nikiel mat  
nickel matt

G6  
chrom mat  
chrome matt



## Dubstep

znal

index	S	W	H	L	P
C-1881	32	9	18	48	100
C-1882	64	9	18	80	100
C-1883	96	9	18	140	100

G5  
nikiel mat  
nickel matt

G6  
chrom mat  
chrome matt

P59  
czarny połysk  
glossy black





## Amaro

znal

index	S	W	H	L	P
C-5285	160	14	29	174	25
C-5286	192	14	29	206	25
C-5289-320	320	14	29	334	25

G2  
chrom połysk  
glossy chrome

G6  
chrom mat  
chrome matt

G49  
cyna postarzana  
old tin

P61  
czarny mat  
black matt





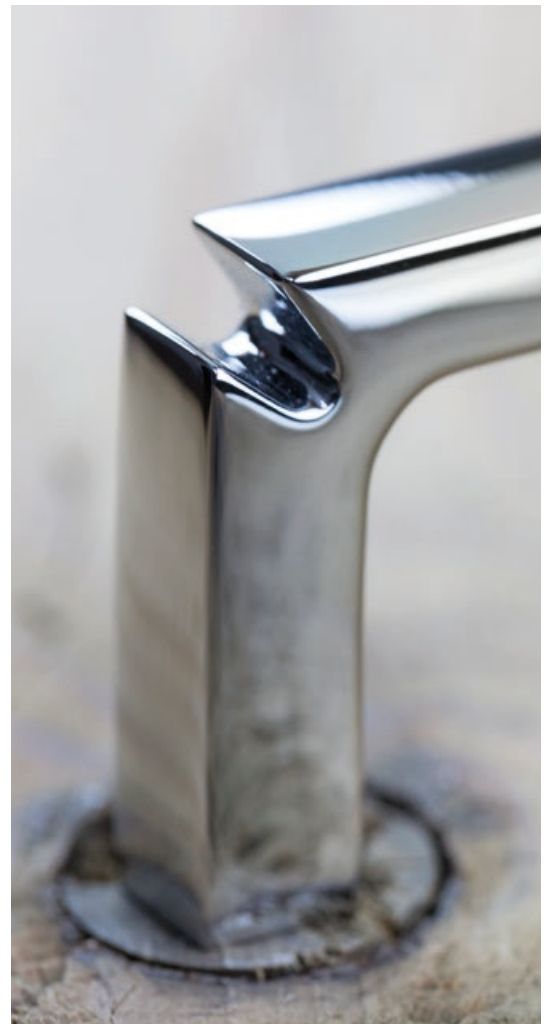

## Ricato

znal

index	S	W	H	L	P
C-5645	160	9	31	169	25
C-5649-320	320	9	31	329	25

G2  
chrom połysk  
glossy chrome

G6  
chrom mat  
chrome matt

P60  
biały połysk  
glossy white

P61  
czarny mat  
black matt



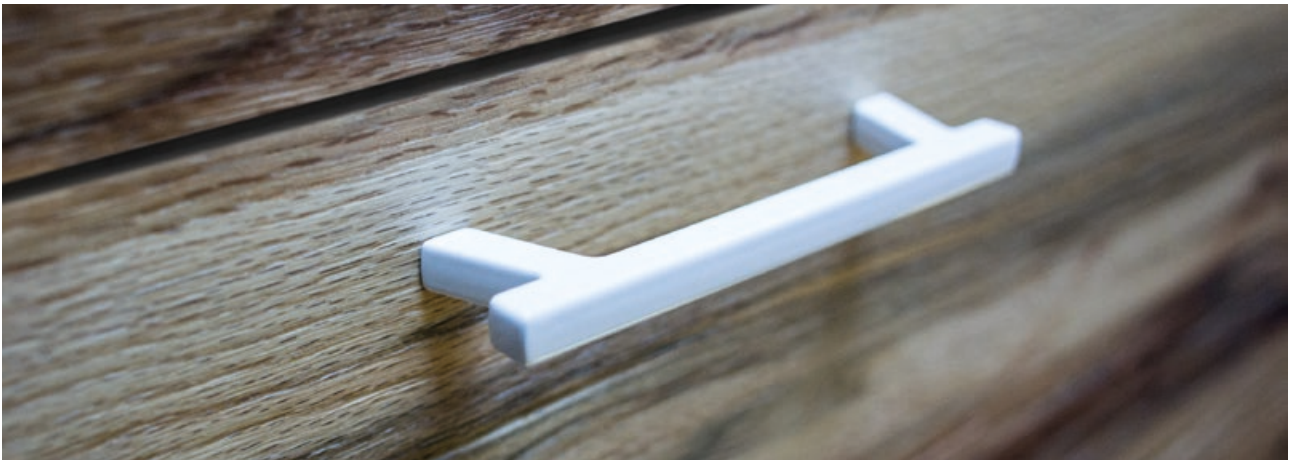

## Verico

znal

index	S	W	H	L	P
C-5293	96	8	28	114	25
C-5295	160	8	28	178	25

G6  
chrom mat  
chrome matt

G70  
miedź czesana  
copper brushed

G77  
złoto matowe czesane  
gold matt brushed

P61  
czarny mat  
black matt

P67  
kość słoniowa  
ivory





## Piano

znal

index	S	W	H	L	P
C-3504	128	21	26	168	50
C-3505	160	26	33	210	50
C-3506	192	26	35	250	25

G2  
chrom połysk  
glossy chrome

G5  
nikiel mat  
nickel matt

G6  
chrom mat  
chrome matt

G8  
stal szlachetna  
stainless steel



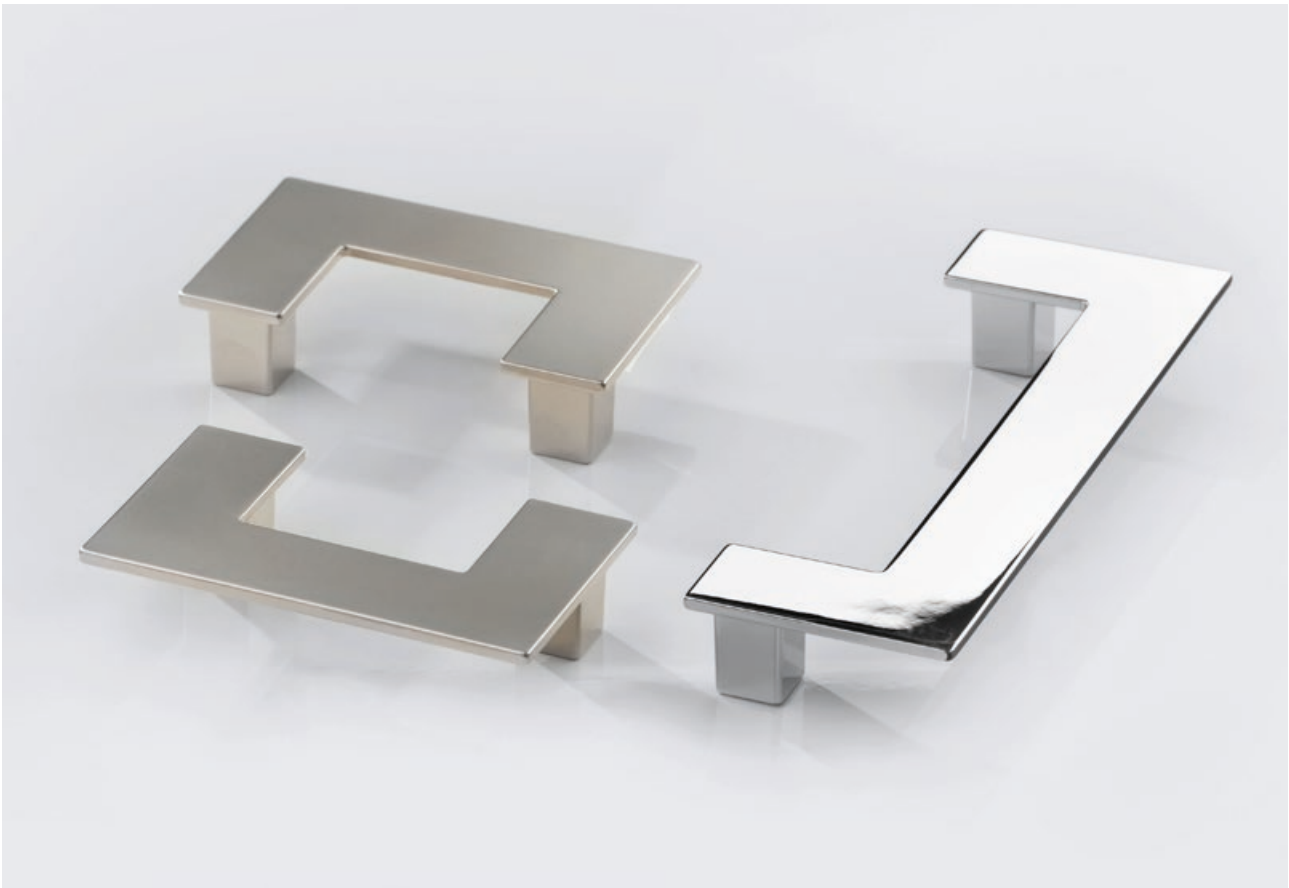

## Solea

znal

index	S	W	H	L	P
C-4132	64	50	21	85	25

index	S	W	H	L	P
C-4134	128	50	21	149	25

G2  
chrom połysk  
glossy chrome

G6  
chrom mat  
chrome matt

P61  
czarny mat  
black matt





## Strada

znal

index	S	W	H	L	P
C-5121	32	10	25	42	25

index	S	W	H	L	P
C-5124	128	10	25	137	25

G2  
chrom połysk  
glossy chrome

P59  
czarny połysk  
glossy black





## Ska

znał

index	S	W	H	L	P
A-955	-	50	18	22	50
C-1891	32	50	18	50	50
C-1892	64	50	18	80	50

G2  
chrom połysk  
glossy chrome

G6  
chrom mat  
chrome matt

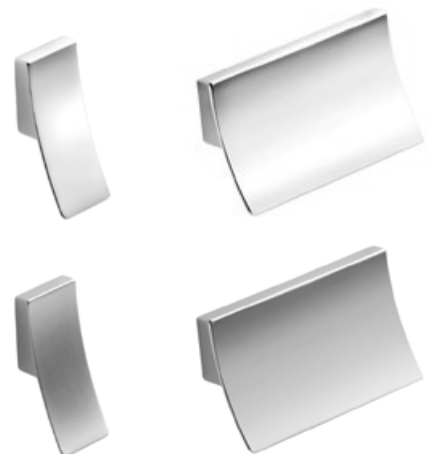

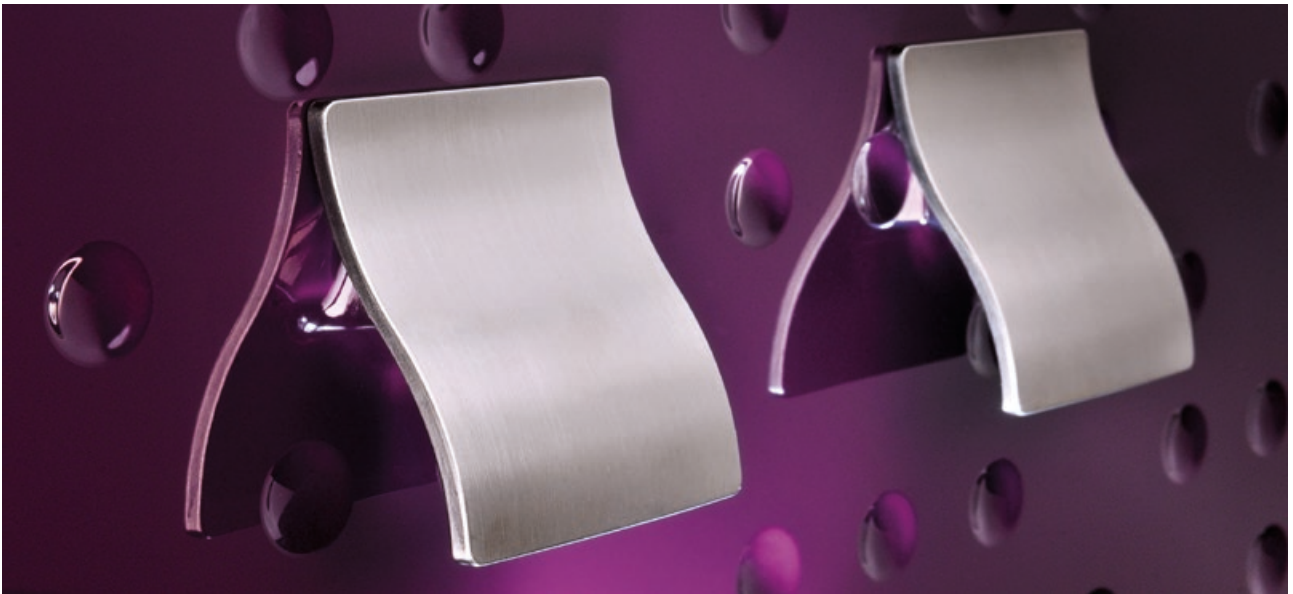

## Pumpin

znal

index	W	H	L	P
C-3031	70	26	80	10

G2  
chrom potysk  
glossy chrome

G6  
chrom mat  
chrome matt

G8  
stal szlachetna  
stainless steel



## Jazz

znal

index	W	H	L	P
C-3042	85	30	84	10

G2  
chrom potysk  
glossy chrome



## Pasto

znal

index	S	W	H	L	P
C-962	64	21	20	102	100

G6  
chrom mat  
chrome matt



## Baltic

znal

index	S	W	H	L	P
C-451	32	20	20	41	100

G2  
chrom połysk  
glossy chrome

G6  
chrom mat  
chrome matt



## Plymouth

znal

index	S	W	H	L	P
C-2701	32	14	46	44	50

G2  
chrom połysk  
glossy chrome

G5  
nikiel mat  
nickel matt

G6  
chrom mat  
chrome matt





## Caracas

znal

index	S	W	H	L	P
C-2331	32	8	20	42	50

G2  
chrom połysk  
glossy chrome



## Fondo

znal

index	S	W	H	L	P
C-5361	32	8	25	41	50

G2  
chrom połysk  
glossy chrome

P61  
czarny mat  
black matt



## Daina

znal

index	S	W	H	L	P
C-3232	64	9	24	75	25

G2  
chrom połysk  
glossy chrome

G5  
nikiel mat  
nickel matt

G6  
chrom mat  
chrome matt



## Virgo

znal

index	S	W	H	L	P
C-1093	96	13	25	106	100
C-1094	128	13	27	138	100

G5  
nikiel mat  
nickel matt

G6  
chrom mat  
chrome matt



## Regulus

znal

index	S	W	H	L	P
C-1083	96	13	25	105	100
C-1084	128	13	26	137	100

G5  
nikiel mat  
nickel matt

G6  
chrom mat  
chrome matt



## Fornax

znal

index	S	W	H	L	P
C-1103	96	13	25	109	100
C-1104	128	13	27	141	100

G5  
nikiel mat  
nickel matt

G6  
chrom mat  
chrome matt



## Victoria

znal

index	S	W	H	L	P
C-2123	96	17	23	138	100
C-2124	128	23	24	184	50

G2  
chrom potysk  
glossy chrome

G5  
nikiel mat  
nickel matt



## Arco

znał

index	S	W	H	L	P
C-622	64	10	24	81	100
C-623	96	10	25	115	100
C-624	128	11	28	160	100

G2  
chrom połysk  
glossy chrome

G4  
patyna na mosiądzu  
antique brass

G5  
nikiel mat  
nickel matt

G6  
chrom mat  
chrome matt



## Argus

znał

index	S	W	H	L	P
C-313A	96	16	29	133	100
C-314	128	16	29	165	100

G2  
chrom połysk  
glossy chrome

G4  
patyna na mosiądzu  
antique brass

G5  
nikiel mat  
nickel matt

G6  
chrom mat  
chrome matt





## Galway

znal

index	S	W	H	L	P
C-1743	96	13	23	141	100

G5  
 nikiel mat  
 nickel matt

G6  
 chrom mat  
 chrome mattyy



## La Paz

znal

index	S	W	H	L	P
C-713	96	15	24	129	100
C-714	128	15	25	158	100

G5  
nikiel mat  
nickel matt

G6  
chrom mat  
chrome matt



## Georgia

znal

index	S	W	H	L	P
C-173A	96	10	28	126	100
C-174	128	10	30	157	100G

G2  
chrom potysk  
glossy chrome

G5  
nikiel mat  
nickel matt

G6  
chrom mat  
chrome matt



## Olivia

znal

index	S	W	H	L	P
C-503	96	12	24	127	100
C-504A	128	13	24	164	100

G2  
chrom potysk  
glossy chrome

G4  
patyna na mosiądzu  
antique brass

G5  
nikiel mat  
nickel matt

G6  
chrom mat  
chrome matt



## Monaco

znal

index	S	W	H	L	P
C-074	128	19	23	141	100

G5  
nikiel mat  
nickel matt

G6  
chrom mat  
chrome matt



## Porto

znal

index	S	W	H	L	P
C-3074	128	15	26	136	100
C-3076	192	19	29	202	50

G5  
nikiel mat  
nickel matt

G6  
chrom mat  
chrome matt



## Tribal

znal

index	S	W	H	L	P
C-3374	128	9	22	159	50

G2  
chrom połysk  
glossy chrome

G5  
nikiel mat  
nickel matt

G8  
stal szlachetna  
stainless steel



## Lahti

znal

index	S	W	H	L	P
C-2044	128	11	33	168	50

G5  
nikiel mat  
nickel matt

G6  
chrom mat  
chrome matt



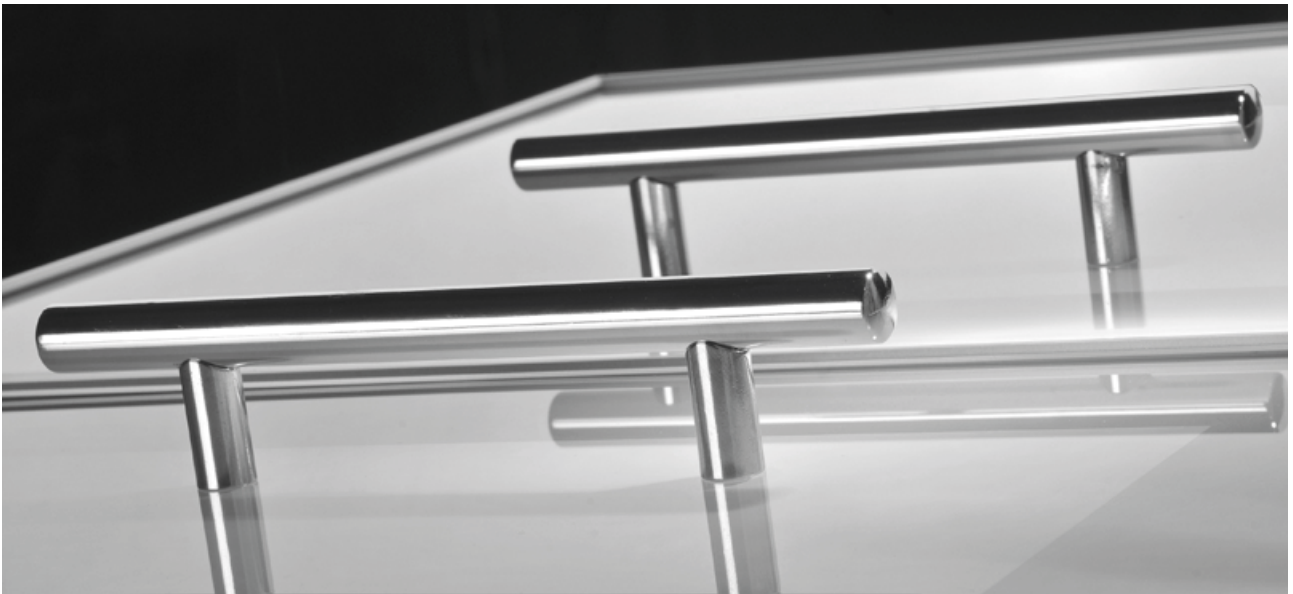

## Santa Cruz

st/znał

index	S	Ø	H	L	P
C-2100-156	96	12	32	156	20
C-2100-188	128	12	32	188	20
C-2100-208	128	12	32	208	20
C-2100-220	160	12	32	220	20
C-2100-240	160	12	32	240	20
C-2100-272	192	12	32	272	20
C-2100-304	224	12	32	304	20
C-2100-356	256	12	32	356	20
C-2100-368	288	12	32	368	20
C-2100-400	320	12	32	400	20
C-2100-432	352	12	32	432	20
C-2100-464	384	12	32	464	20
C-2100-496	416	12	32	496	20
C-2100-528	448	12	32	528	20
C-2100-560	480	12	32	560	20
C-2100-592	512	12	32	592	20
C-2100-624	544	12	32	624	20
C-2100-656	576	12	32	656	20
C-2100-752	672	12	32	752	10

G2  
chrom połysk  
glossy chrome

G5  
nikiel mat  
nickel matt

G6  
chrom mat  
chrome matt

G8  
stal szlachetna  
stainless steel

P61  
czarny mat  
black matt





## Celer

znal

index	S	W	H	L	A	B	C	P
C-1751	32	35	17	44	40	31	14	50
C-1753	96	42	17	108	104	38	14	50
C-1755	160	42	17	174	168	38	14	25

G5  
 nikiel mat  
 nickel matt

G6  
 chrom mat  
 chrome matt



## Quadrum

znal

index	W	H	L	P
A-1135	45	16,5	45	25

G5  
 nikiel mat  
 nickel matt

G6  
 chrom mat  
 chrome matt







## Vinella

znal

index	W	H	L	P
B-160	16	50	50	25

G2  
chrom połysk  
glossy chrome

G49  
cyna postarzana  
old tin



## Liberc

znal

index	Ø	H	P
A-1294	30	20	50

G2  
chrom połysk  
glossy chrome

G6  
chrom mat  
chrome matt







**nomet**

gałki / knobs



## Diuna

znal

index	W	H	L	P
A-1562	30	25	38,5	25

G2  
chrom potysk  
glossy chrome

G5  
nikiel mat  
nickel matt

G6  
chrom mat  
chrome matt

G49  
cyna postarzana  
old tin

G77  
złoto matowe czesane  
gold matt brushed





## Marsias

znał

index	Ø	H	P
A-1234	30	29	100

G71  
stary nikiel  
old nickel



## Sedin

znał

index	Ø	H	P
A-743	31	21	100

G71  
stary nikiel  
old nickel





## Tanza

złot

index	W	H	L	P
A-1393	20	22	28	50

K1-G35M  
srebro postarzone  
old silver

  
SWAROVSKI



## Ikar

złot

index	Ø	H	P
A-1014	30	22	100

G4  
patyna na miedzi  
antique brass

G49  
cyna postarzana  
old tin

P61  
czarny mat  
black matt





## Perseus

znał

index	W	H	L	P	
A-1053	-	25	27	-	100
E-580	37	21	-	45	100

G4  
patyna na mosiądzu  
antique brass



## Pinus

znał

index	W	H	L	P	
A-256	15	26	37	100	

T41-G4  
kość słoniowa-patyna na mosiądzu  
ivory-antique brass





## Soho

znal

index	W	H	L	P
B-150	25	20	58	100

G4  
patyna na miedzi  
antique brass

G71  
stary nikiel  
old nickel



## Hino

znal

index	W	H	L	P
B-070	35	16	55	100

G4  
patyna na miedzi  
antique brass







## Mars

znal

index	W	H	L	P
B-090	63	17	51	100

G4  
patyna na mosiądzu  
antique brass



## Hestia

znal

index	Ø	W	H	L	P
A-013	25	-	23	-	100
E-450	-	34	-	63	100

G4  
patyna na mosiądzu  
antique brass



## Demeter

znal

index	W	H	L	P
A-025	20	21	35	100
E-460	25	-	79	100

G4  
patyna na mosiądzu  
antique brass



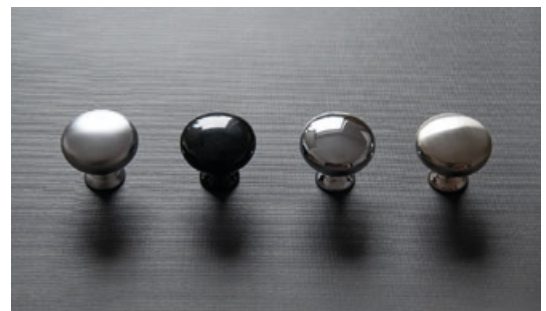
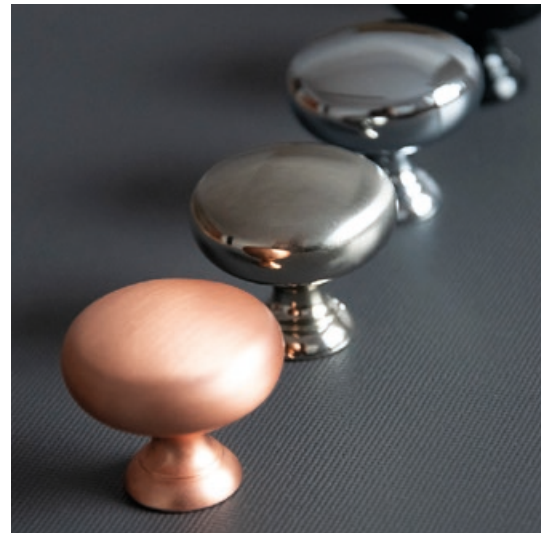

index	Ø	H	P
A-823	31	29	100

- G2 chrom połysk  
glossy chrome
- G3 złoty połysk  
glossy gold
- G5 nikiel mat  
nickel matt
- G6 chrom mat  
chrome matt
- G8 stal szlachetna  
stainless steel
- G49 cyna postarzana  
old tin
- G70 miedź czesana  
copper brushed
- G77 złoto matowe czesane  
gold matt brushed
- P59 czarny połysk  
glossy black
- P60 biały połysk  
glossy white
- P61 czarny mat  
black matt

## Toronto

znal



## Napoli

znal

index	W	H	L	P
A-325	23	27	36	100

- G2  
chrom połysk  
glossy chrome
- G3  
złoty połysk  
glossy gold
- G4  
patyna na miedzi  
antique brass
- G5  
nikiel mat  
nickel matt
- G6  
chrom mat  
chrome matt
- G8  
stal szlachetna  
stainless steel
- G77  
złoto matowe czesane  
gold matt brushed
- P59  
czarny połysk  
glossy black
- P60  
biały połysk  
glossy white
- P61  
czarny mat  
black matt



## Carlo

znal

index	W	H	L	P
A-077A	21	25	43	25

- G2  
chrom połysk  
glossy chrome
- G3  
złoty połysk  
glossy gold
- G6  
chrom mat  
chrome matt
- G49  
cyna postarzana  
old tin
- TL77  
złoto matowe  
gold matt
- P61  
czarny mat  
black matt



## Astro

znal

index	Ø	H	P
A-1503	36	19	25

G2  
chrom połysk  
glossy chrome

G3  
złoty połysk  
glossy gold

G6  
chrom mat  
chrome matt

G49  
cyna postarzana  
old tin

TL77  
złoto matowe  
gold matt

P61  
czarny mat  
black matt



## Ambient

znal

index	Ø	H	P
A-312	25	25	100

G2  
chrom połysk  
glossy chrome

G5  
nikiel mat  
nickel matt

G6  
chrom mat  
chrome matt

G8  
stal szlachetna  
stainless steel

G70  
miedź czesana  
copper brushed

G77  
złoto matowe czesane  
gold matt brushed

P61  
czarny mat  
black matt



## Milan

znał

index	W	H	L	P
A-246	27	26	37	100

G2  
chrom połysk  
glossy chrome

G4  
patyna na mosiądzu  
antique brass

G5  
nikiel mat  
nickel matt

G6  
chrom mat  
chrome matt

P59  
czarny połysk  
glossy black

P60  
biały połysk  
glossy white



## Sydney

znał

index	Ø	H	P
A-400	24	20	100

G2  
chrom połysk  
glossy chrome

G5  
nikiel mat  
nickel matt

G6  
chrom mat  
chrome matt

G77  
złoto matowe czesane  
gold matt brushed

P59  
czarny połysk  
glossy black

P60  
biały połysk  
glossy white

P61  
czarny mat  
black matt



## Pallada

znal

index	Ø	H	P
A-763	30	22	100

P61  
czarny mat  
black matt



## Afrodyta

znal

index	Ø	H	P
A-264	28	22	100

P61  
czarny mat  
black matt



## Virgo

znal

index	Ø	H	P
A-464	28	23	100

G5  
nikiel mat  
nickel matt

G6  
chrom mat  
chrome matt



## Reggae

znal

index	W	H	L	P
A-1272	20	23	20	100

G2  
chrom potysk  
glossy chrome

G5  
nikiel mat  
nickel matt

G6  
chrom mat  
chrome matt



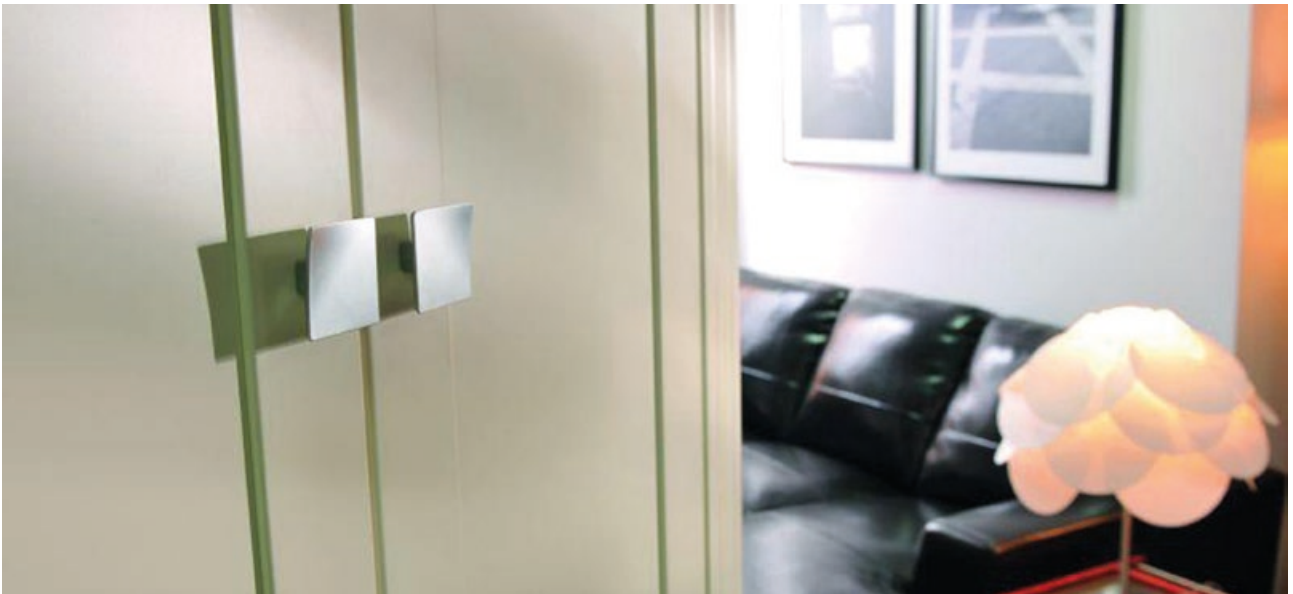

## Blues

znał

index	W	H	L	P
A-1313	45	22	45	50

G2  
chrom połysk  
glossy chrome

G5  
nikiel mat  
nickel matt

G6  
chrom mat  
chrome matt



## Altro

znał

index	S	W	H	L	P
C-3710	16	59	21	59	10
C-3711	32	90	24	90	10

G2  
chrom połysk  
glossy chrome





## Ars Nova

złot

index	Ø	H	P
A-1455	61	25	10

G4-G2  
patyna na mosiądzu-chrom połysk  
antique brass-glossy chrome

G5-G2  
nikiel mat-chrom połysk  
nickel matt-glossy chrome

G6-G2  
chrom mat-chrom połysk  
chrome matt-glossy chrome

G8-G2  
stal szlachetna-chrom połysk  
stainless steel-glossy chrome

P1-G2  
biały-chrom połysk  
white-glossy chrome

P2-G2  
czarny-chrom połysk  
black-glossy chrome







## Big Beat

znał

index	H	L	P
A-1465	24	57	10

G4-G2  
patyna na mosiądzu-chrom połysk  
antique brass-glossy chrome

G5-G2  
nikiel mat-chrom połysk  
nickel matt-glossy chrome

G6-G2  
chrom mat-chrom połysk  
chrome matt-glossy chrome

G8-G2  
stal szlachetna-chrom połysk  
stainless steel-glossy chrome

P1-G2  
biały-chrom połysk  
white-glossy chrome

P2-G2  
czarny-chrom połysk  
black-glossy chrome





## Grime

znal/plst

index	Ø	H	P
A-1425	60	25	10

G2  
chrom połysk  
glossy chrome

G5  
nikiel mat  
nickel matt

G6  
chrom mat  
chrome matt

T37  
niebieski  
blue

T38  
biały  
white

T39  
czerwony  
red

T40  
pomarańczowy  
orange



## Calypso

znal/plst

index	W	H	L	P
A-1405	55	24	55	10

G2  
chrom połysk  
glossy chrome

G5  
nikiel mat  
nickel matt

G6  
chrom mat  
chrome matt

T10  
czarny  
black

T37  
niebieski  
blue

T38  
biały  
white

T39  
czerwony  
red

T40  
pomarańczowy  
orange



## Trip Hop

znal/plst

index	W	H	L	P
A-1415	60	24	60	10

G2  
chrom połysk  
glossy chrome

G5  
nikiel mat  
nickel matt

G6  
chrom mat  
chrome matt

T10  
czarny  
black

T37  
niebieski  
blue

T38  
biały  
white

T39  
czerwony  
red

T40  
pomarańczowy  
orange







listwy aluminiowe / aluminum handles



## Highway

al

index	L	P
C-3590-146	146	1
C-3590-196	196	1
C-3590-246	246	1
C-3590-296	296	1
C-3590-346	346	1
C-3590-396	396	1
C-3590-446	446	1
C-3590-496	496	1
C-3590-596	596	1
C-3590-696	696	1
C-3590-796	796	1
C-3590-896	896	1
C-3590-996	996	1
C-3590-1096	1096	1
C-3590-1196	1196	1



A1  
anoda naturalna  
anodized natural

A11  
anoda szczotkowana  
anodized brushed

G2  
chrom połysk  
glossy chrome

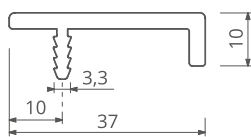



## Andare

al

index	L	P
C-5750-146	146	1
C-5750-196	196	1
C-5750-246	246	1
C-5750-296	296	1
C-5750-346	346	1
C-5750-396	396	1
C-5750-446	446	1
C-5750-496	496	1
C-5750-596	596	1
C-5750-696	696	1
C-5750-796	796	1
C-5750-896	896	1
C-5750-996	996	1
C-5750-1096	1096	1
C-5750-1196	1196	1

A1  
anoda naturalna  
anodized natural

A11  
anoda szczotkowana  
anodized brushed

G2  
chrom połysk  
glossy chrome

G49  
cyna postarzana  
old tin

P61  
czarny mat  
black matt

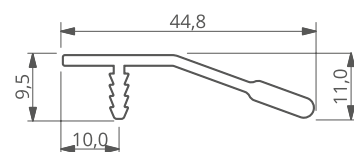
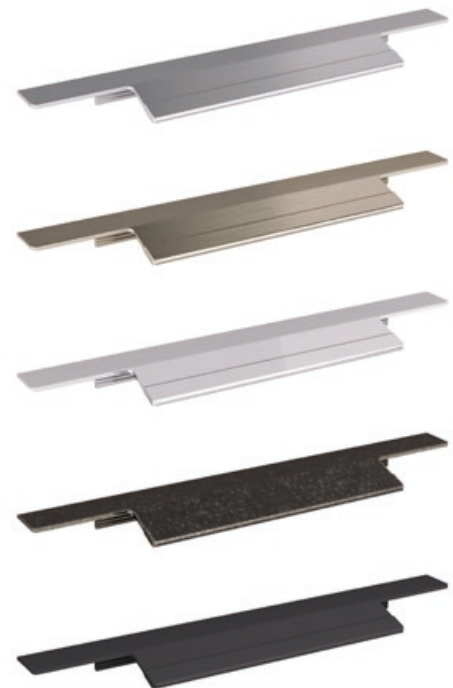



## Vera

al

index	S	L	P
C-4909A-94	64	94	25
C-4909A-126	96	126	25
C-4909A-158	128	158	25
C-4909A-190	160	190	25
C-4909A-222	192	222	25
C-4909A-286	256	286	25
C-4909A-350	320	350	25

A1  
anoda naturalna  
anodized natural

A2  
anoda złota  
anodized gold

G2  
chrom połysk  
glossy chrome

P60  
biały połysk  
glossy white

P61  
czarny mat  
black matt

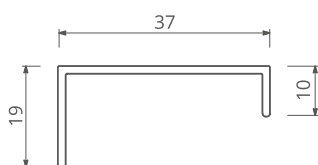
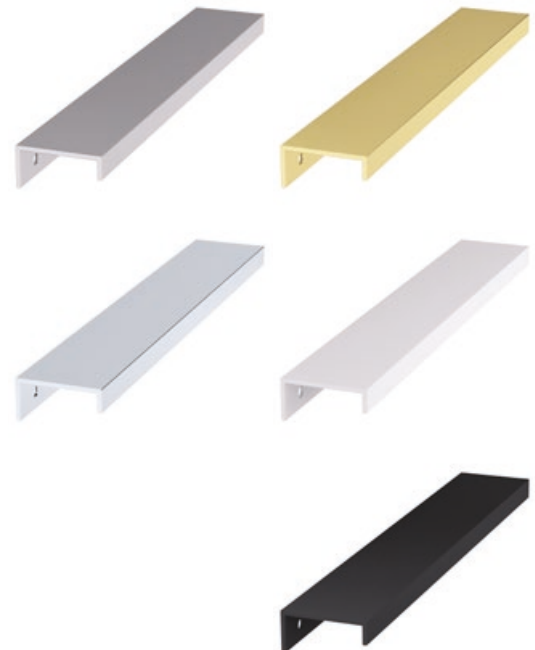



## Terra Pro

al

index	S	L	P
C-5000A-158-R10	128	158	25
C-5000A-190-R10	160	190	25
C-5000A-222-R10	192	222	25
C-5000A-286-R10	256	286	25
C-5000A-350-R10	320	320	25

A1  
anoda naturalna  
anodized natural

A11  
anoda szczotkowana  
anodized brushed

G2  
chrom połysk  
glossy chrome

P61  
czarny mat  
black matt

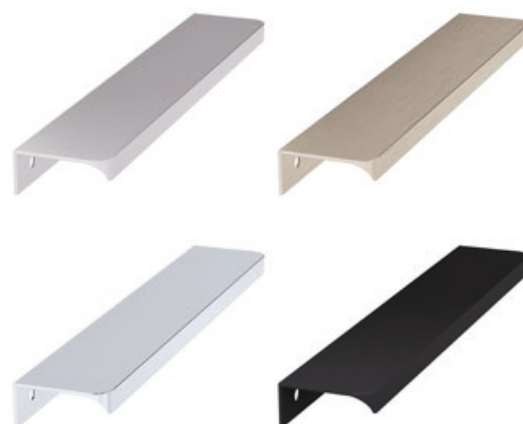
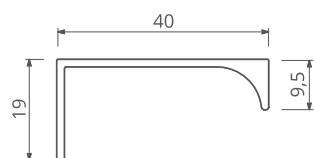

## Terra

al

index	S	L	P
C-5000A-158	128	158	25
C-5000A-190	160	190	25
C-5000A-222	192	222	25
C-5000A-286	256	286	25
C-5000A-350	320	350	25

A1  
anoda naturalna  
anodized natural

A10S  
anoda czarna szczotkowana  
anodized black brushed

A11  
anoda szczotkowana  
anodized brushed

G2  
chrom połysk  
glossy chrome

P61  
czarny mat  
black matt

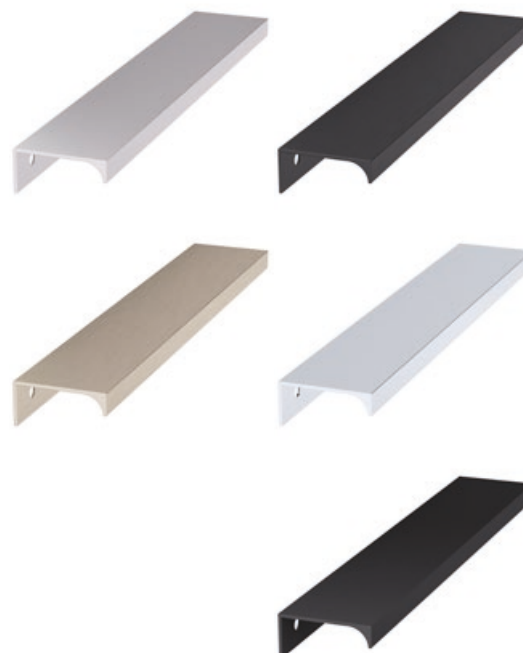
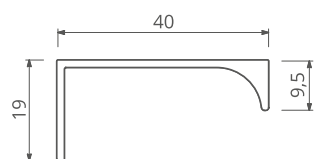



## Costa

al

index	S	L	P
C-4789A-94	64	94	25
C-4789A-126	96	126	25
C-4789A-158	128	158	25
C-4789A-190	160	190	25
C-4789A-222	192	222	25
C-4789A-286	256	286	25
C-4789A-350	320	350	25

A1  
anoda naturalna  
anodized natural

A2  
anoda złota  
anodized gold

A11  
anoda szczotkowana  
anodized brushed

G2  
chrom połysk  
glossy chrome

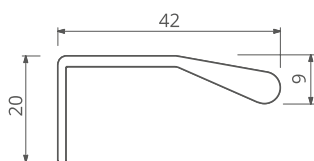
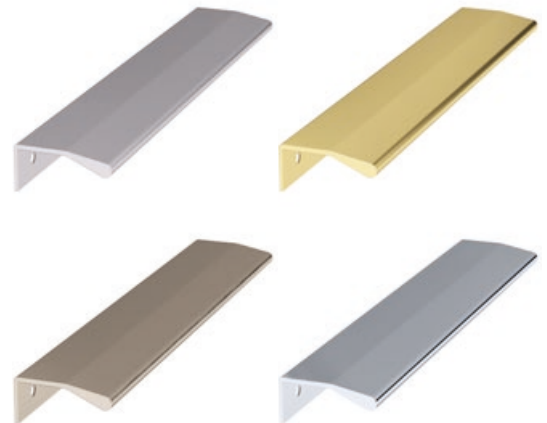

## Nolan

al

index	S	L	P
C-5519A-158	128	158	25
C-5519A-190	160	190	25
C-5519A-222	192	222	25
C-5519A-286	256	286	25
C-5519A-350	320	350	25

G2  
chrom połysk  
glossy chrome

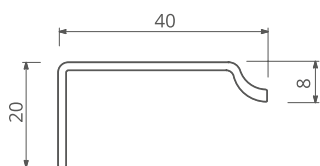

## Tonga

al

index	S	L	P
C-5539A-158	128	158	25
C-5539A-190	160	190	25
C-5539A-222	192	222	25
C-5539A-286	256	286	25
C-5539A-350	320	350	25

A1  
anoda naturalna  
anodized natural

A11  
anoda szczotkowana  
anodized brushed

G2  
chrom połysk  
glossy chrome

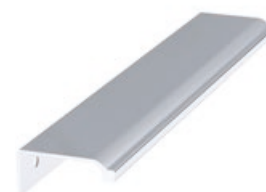
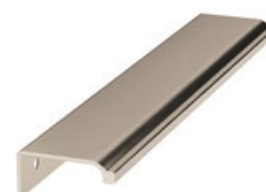
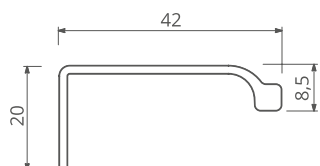



## Verba

al

index	S	W	H	L	P
C-5810-92/64	64	40	18	92	25
C-5810-340/320	320	40	18	340	10

P60  
biały połysk  
glossy white

P61  
czarny mat  
black matt

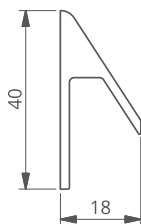



## Vena

al

index	S	L	P
C-5020-148	128	148	25
C-5020-180	160	180	25
C-5020-212	192	212	25
C-5020-276	256	276	25
C-5020-340	320	340	25

A2  
anoda złota  
anodized gold

A11  
anoda szczotkowana  
anodized brushed

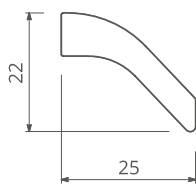



## Veleno

al

index	S	L	P
C-5080-148	128	148	25
C-5080-180	160	180	25
C-5080-212	192	212	25
C-5080-276	256	276	25
C-5080-340	320	340	25

A1  
anoda naturalna  
anodized natural

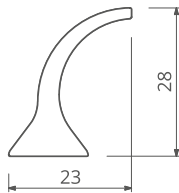

## Fado

al

index	S	L	P
C-2360-148	128	148	25
C-2360-180	160	180	25
C-2360-212	192	212	25
C-2360-276	256	276	25
C-2360-340	320	340	25

A1  
anoda naturalna  
anodized natural

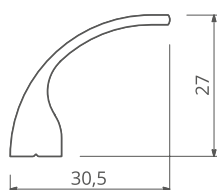

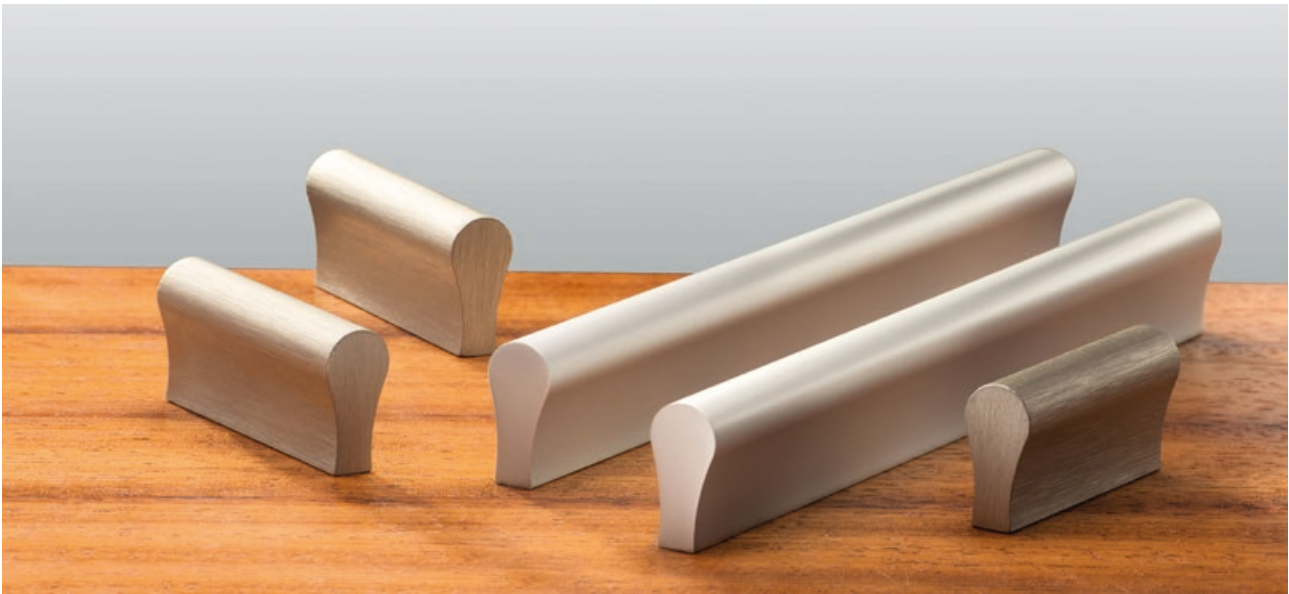

## Makao

al

index	S	L	P
C-1760-148	128	148	25
C-1760-212	192	212	25
C-1760-340	320	340	25

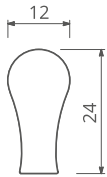

A1  
anoda naturalna  
anodized natural

A11  
anoda szczotkowana  
anodized brushed



## Malta

al

index	S	L	P
C-2050-148	128	148	25
C-2050-180	160	180	25
C-2050-212	192	212	25
C-2050-276	256	276	25
C-2050-340	320	340	25

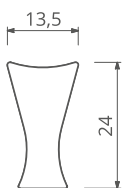

A1  
anoda naturalna  
anodized natural

A11  
anoda szczotkowana  
anodized brushed





## Tiro

al

index	S	L	P
C-5370-148	128	148	25
C-5370-180	160	180	25
C-5370-212	192	212	25
C-5370-276	256	276	25
C-5370-340	320	340	25

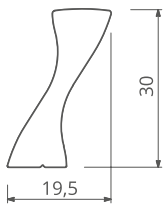

A1  
anoda naturalna  
anodized natural



## Avere

al

index	S	L	P
C-5010-148	128	148	25
C-5010-180	160	180	25
C-5010-212	192	212	25
C-5010-276	256	276	25
C-5010-340	320	340	25

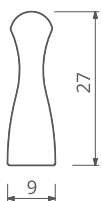

A11  
anoda szczotkowana  
anodized brushed





## Latino

al

index	S	L	P
C-1770-148	128	148	25
C-1770-180	160	180	25
C-1770-212	192	212	25
C-1770-276	256	276	25
C-1770-340	320	340	25

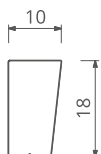

A1  
anoda naturalna  
anodized natural

A11  
anoda szczotkowana  
anodized brushed

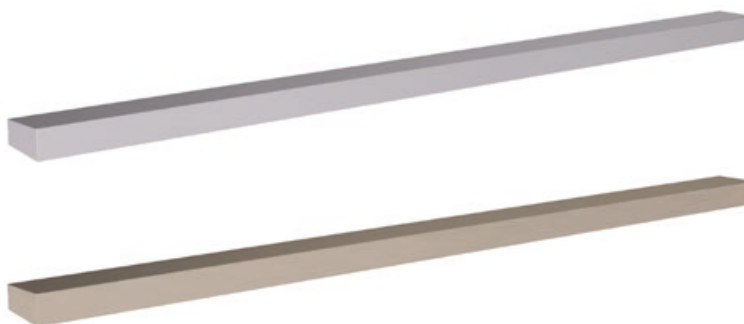

## Essen

al

index	S	L	P
C-2020-148	128	148	50
C-2020-180	160	180	50
C-2020-212	192	212	50
C-2020-276	256	276	50
C-2020-340	320	340	50

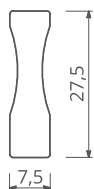

A2  
anoda złota  
anodized gold

A11  
anoda szczotkowana  
anodized brushed



## Sartre

al

index	S	L	P
C-5779-92/64	64	92	25
C-5779-348/320	320	348	10

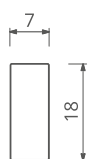

A1  
anoda naturalna  
anodized natural

P61  
czarny mat  
black matt







**nomet**

wieszaki / hooks



## Louisiana

znal

index	Ø	Ø	H	P
Z-5412	25	18	47	100

G2  
chrom połysk  
glossy chrome

G5  
nikiel mat  
nickel matt

G6  
chrom mat  
chrome matt

G8  
stal szlachetna  
stainless steel

TL77  
złoto matowe  
gold matt



## Cartagena

znal

index	Ø	H	P
A-995A	20	50	100

G6  
chrom mat  
chrome matt

TL77  
złoto matowe  
gold matt

P61  
czarny mat  
black matt



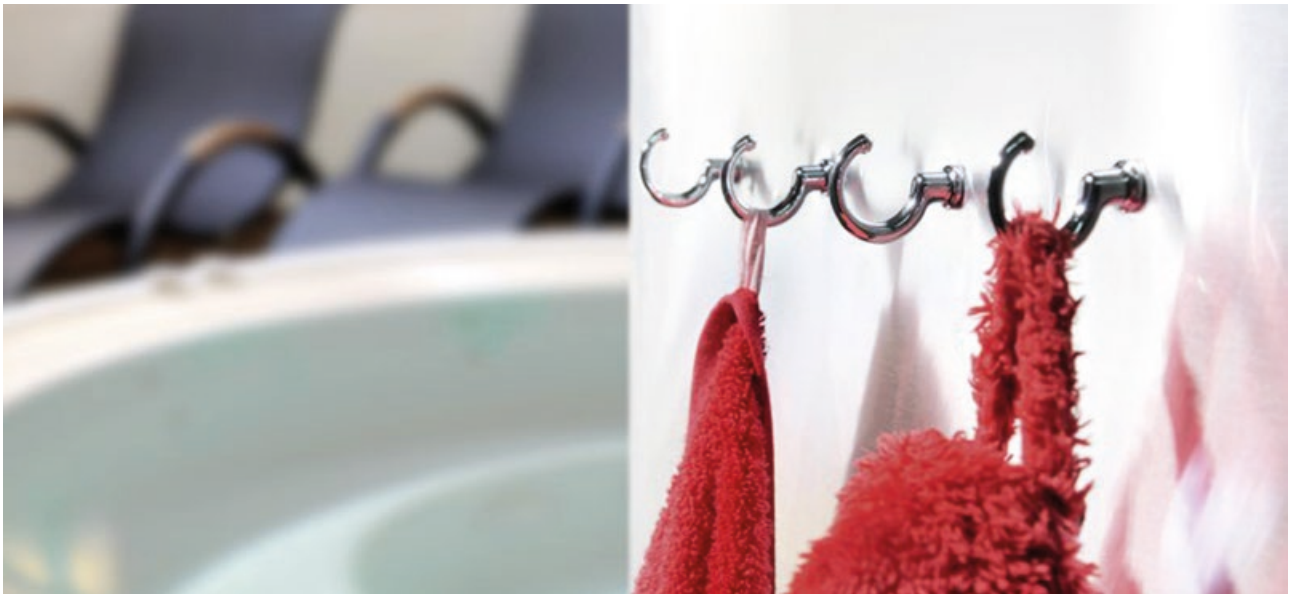

## Ontario

znal

index	Ø	H	L	P
Z-422	12	35	28	100
Z-423	15	44	33	100

G2  
chrom połysk  
glossy chrome

G4  
patyna na miedzi  
antique brass

G5  
nikiel mat  
nickel matt

G6  
chrom mat  
chrome matt



## Dominica

znal

index	S	W	H	L	P
Z-391	18	58	29	32	100

G2  
chrom połysk  
glossy chrome

G3  
złoty połysk  
glossy gold

G4  
patyna na miedzi  
antique brass

G5  
nikiel mat  
nickel matt

G6  
chrom mat  
chrome matt

P61  
czarny mat  
black matt

P67  
kość słoniowa  
ivory





## Arto

znal

index	S	W	H	L	P
Z-5426	16	34	51	79	25

G2  
chrom połysk  
glossy chrome

G6  
chrom mat  
chrome matt

P61  
czarny mat  
black matt

P67  
kość słoniowa  
ivory

TL77  
złoto matowe  
gold matt

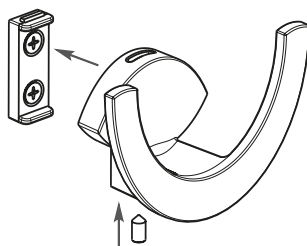



## Sol

znal

index	S	W	H	L	P
Z-5402	23	41	31	65	50
Z-5401	23	72	82	191	25

G4  
patyna na miedzi  
antique brass







## Yukon

znal

index	S	W	H	L	P
Z-361	20	78	30	47	50

G2  
chrom połysk  
glossy chrome

G3  
złoty połysk  
glossy gold

G4  
patyna na mosiądzu  
antique brass

G5  
nikiel mat  
nickel matt

G6  
chrom mat  
chrome matt

P61  
czarny mat  
black matt

P67  
kość słoniowa  
ivory



## Celebes

znal

index	S	W	H	L	P
Z-375	20	78	77	125	50

G2  
chrom połysk  
glossy chrome

G3  
złoty połysk  
glossy gold

G4  
patyna na mosiądzu  
antique brass

G5  
nikiel mat  
nickel matt

G6  
chrom mat  
chrome matt

P61  
czarny mat  
black matt

P67  
kość słoniowa  
ivory





## Argus

znał

index	S	W	H	L	P
Z-341	32	78	32	58	50
Z-355	32	78	65	148	50

G2  
chrom połysk  
glossy chrome

G3  
złoty połysk  
glossy gold

G5  
nikiel mat  
nickel matt

G6  
chrom mat  
chrome matt

P61  
czarny mat  
black matt

P67  
kość słoniowa  
ivory





## Deep

znal

index	S	W	H	L	P
Z-5408	32	60	60	180	10

G2  
chrom potysk  
glossy chrome







## Ponti

al

index	S	W	H	L	P
Z-5419-400	64	10	40	400	1

G2  
chrom połysk  
glossy chrome

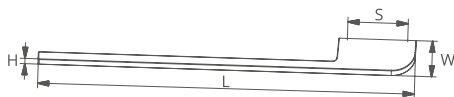

## Dante

al

index	S	W	H	L	P
Z-5420-400	64	10	40	400	1

G2  
chrom połysk  
glossy chrome

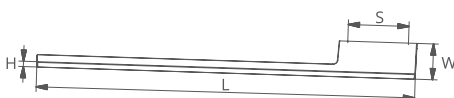



## Prato

znal/st

index	S	H	L	P
Z-5442	288	70	400	1

TL77-P61  
złoto matowe-czarny mat  
gold matt -black matt

P61-P61  
czarny mat-czarny mat  
black matt-black matt

index	Ø	H	P
Cartagena A-995A	20	50	100

TL77  
złoto matowe  
gold matt

P61  
czarny mat  
black matt

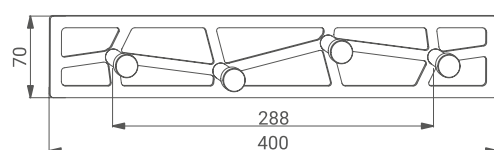



## Ska

zmal/st

index	S	H	L	P
Z-5438	352	30	400	1

P67  
kość słoniowa  
ivory

P61  
czarny mat  
black matt

index	W	H	L	P
A-955	50	18	22	50

P67  
kość słoniowa  
ivory

P61  
czarny mat  
black matt

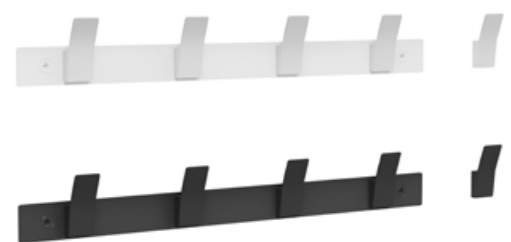



## Libretto

znal/st

index	S	H	L	P
Z-5436	352	45	400	1

G4  
patyna na miedzi  
antique brass

G49  
cyna postarzana  
old tin



index	W	H	L	P
Z-5421	22	28	54	25

G4  
patyna na miedzi  
antique brass

G49  
cyna postarzana  
old tin

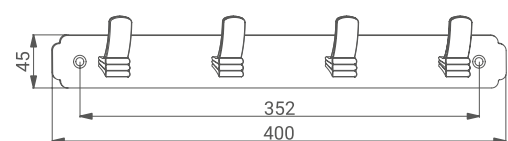





## Redo

znal/st

index	S	H	L	P
Z-5437	352	45	400	1

G5  
 nikiel mat  
 nickel matt

G49  
 cyna postarzana  
 old tin

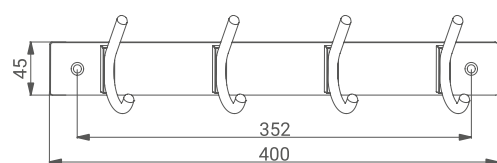
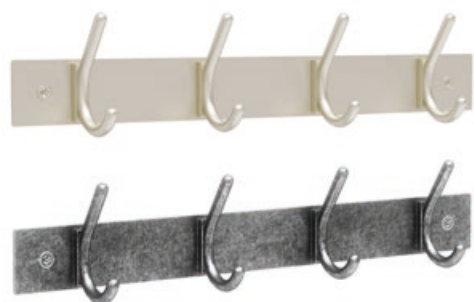



## Cartagena

znal/st

index	S	H	L	P
Z-5440	96	40	178	1

G6  
chrom mat  
chrome matt



index	S	H	L	P
Z-5441	288	40	370	1

G6  
chrom mat  
chrome matt



index	Ø	H	P
A-995A	20	50	100

G6  
chrom mat  
chrome matt

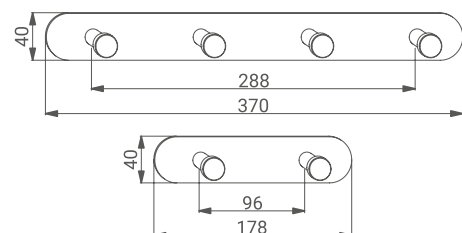



## Alvero

zmal/st

index	S	H	L	P
Z-5439	352	45	400	1

G2  
chrom połysk  
glossy chrome

G5  
nikiel mat  
nickel matt



index	S	W	H	L	P
Z-5423A	16	21	31	48	25

G2  
chrom połysk  
glossy chrome

G5  
nikiel mat  
nickel matt

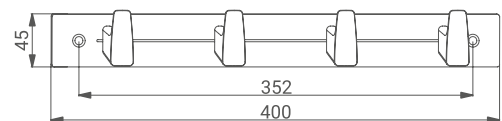



## Campana

al/zna1

index	S	W	H	L	P
Z-5445-680	680	232	70	690	1

A1-G6  
 anoda naturalna-chrom mat  
 anodized natural-chrome matt

A10-P61  
 anoda czarna-czarny mat  
 anodized black-black matt

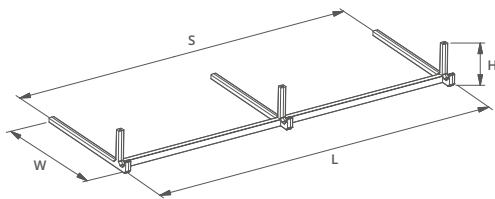

## Campana

al/znał

index	S	W	H	L	P
Z-5445A-590	590	232	70	600	1

A1-G6  
anoda naturalna-chrom mat  
anodized natural-chrome matt

A10-P61  
anoda czarna-czarny mat  
anodized black-black matt

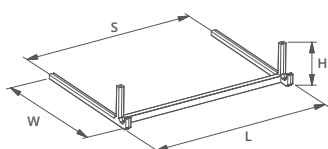

## Campana

znał

index	S/S1	W	H	L	P
Z-5445	205/65	232	70	10	20

G6  
chrom mat  
chrome matt

P61  
czarny mat  
black matt

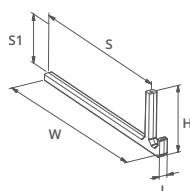

## Campana

znał

index	S	W	H	L	P
Z-5444	32	40	45	10	50

G6  
chrom mat  
chrome matt

P61  
czarny mat  
black matt





## Alvero

al/zna1

index	S	W	H	L	P
Z-6823-680	680	220	111	700	1

G2  
chrom połysk  
glossy chrome

G6  
chrom mat  
chrome matt

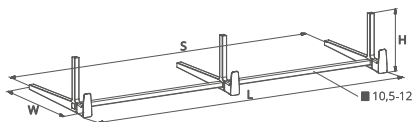

## Alvero

al/zna1

index	S	W	H	L	P
Z-6823A-590	590	220	111	610	1

G2  
chrom połysk  
glossy chrome

G6  
chrom mat  
chrome matt

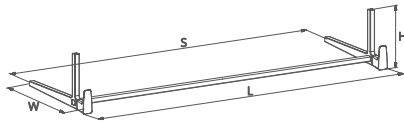

## Alvero

zna1

index	S/S1	W	H	L	P
Z-6823	173/100	220	111	20	5

G2  
chrom połysk  
glossy chrome

G6  
chrom mat  
chrome matt

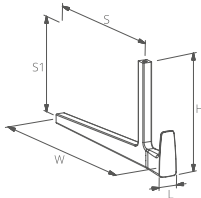

## Alvero

zna1

index	S	W	H	L	P
A-1542	-	21	30	26	25
Z-5423A	16	21	31	48	25
Z-5423	16	29	31	63	25

G2  
chrom połysk  
glossy chrome

G6  
chrom mat  
chrome matt





## Asti

st/znał

index	S	W	H	L	P
Z-5309A-590	590	234	56	612	1

G6  
chrom mat  
chrome matt

P61  
czarny mat  
black matt

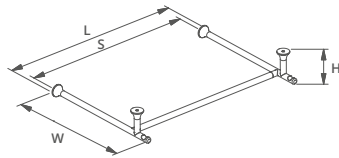

## Asti

st/znał

index	S/S1	W	H	L	P
Z-5309-680	680	234	56	702	1

G6  
chrom mat  
chrome matt

P61  
czarny mat  
black matt

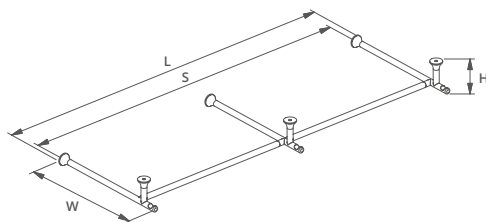





## Tavolo

al/znał

index	S	W	H	L	P
Z-6841A-590	590	234	71	614	1

G2-G2  
chrom połysk-chrom połysk  
glossy chrome-glossy chrome

A10-P61  
anoda czarna-czarny mat  
anodized black-black matt



## Tavolo

znał

index	S	W	H	L	P
A-1552	-	24	27	26	25
C-5265	160	24	27	184	25

G2  
chrom połysk  
glossy chrome

P61  
czarny mat  
black matt





## Crudo

st

index	S/S1	W	H	L	P
Z-6827-700	400/660	235	74	700	1

G5  
nikiel mat  
nickel matt

G6  
chrom mat  
chrome matt

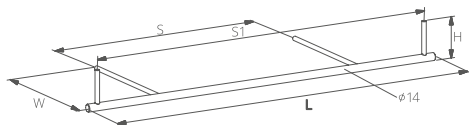

## Silen

st

index	S/S1	W	H	L	P
Z-6814-680	661/640	234	74	680	1

G5  
nikiel mat  
nickel matt

G6  
chrom mat  
chrome matt

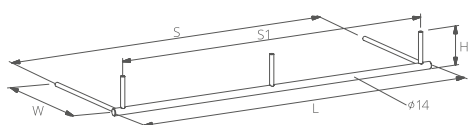



## Aspro

st

index	S	W	P
Z-6811-203	209	116	20

G5  
nikiel mat  
nickel matt

G6  
chrom mat  
chrome matt

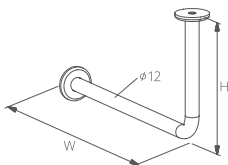

## Antago

st

index	S	W	H	L	P
Z-6806	288	10	50	298	1

G5  
nikiel mat  
nickel matt

G6  
chrom mat  
chrome matt

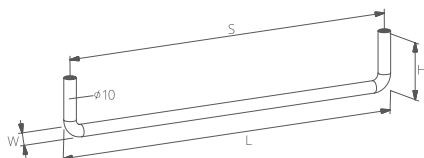





nogi do mebli / furniture legs



# Nogi ze stelażem Eren – kpl. Legs with frame Eren – set

znal/al



Z-6913-600.P61



Z-6913-600.P94



Z-6913-600.TL77

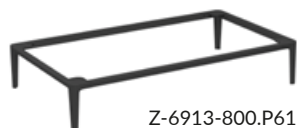

Z-6913-800.P61

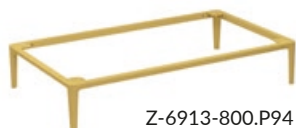

Z-6913-800.P94

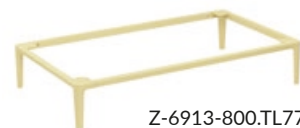

Z-6913-800.TL77

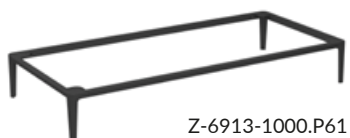

Z-6913-1000.P61

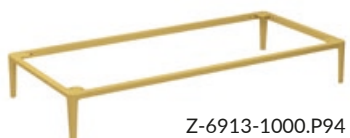

Z-6913-1000.P94

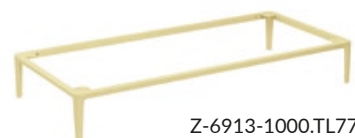

Z-6913-1000.TL77

P61  
czarny mat  
black matt

P94  
złoty  
gold

TL77  
złoto matowe  
gold matt

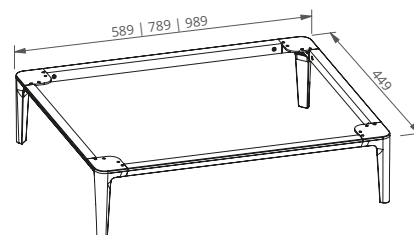

\*oferta nie dotyczy rynku brytyjskiego  
\* this offer does not apply in the UK

## Eren

znal

index	H	P
Z-6913-001	140	2

P61  
czarny mat  
black matt

P94  
złoty  
gold

TL77  
złoto matowe  
gold matt

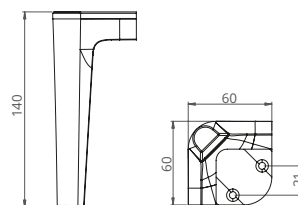

\*oferta nie dotyczy rynku brytyjskiego  
\* this offer does not apply in the UK

# Avanti

al/st

index	H	P
Z-4619-100RA1	100	2
Z-4619-150RA1	150	2



index	H	P
Z-4620-100RA1	100	2
Z-4620-150RA1	150	2



index	H	P
Z-4621-100RA1	100	2
Z-4621-150RA1	150	2



A2-P61  
anoda złota-czarny mat  
anodized gold-black matt

A10-P61  
anoda czarna-czarny mat  
anodized black-black matt

G2-P61  
chrom połysk-czarny mat  
glossy chrome-black matt

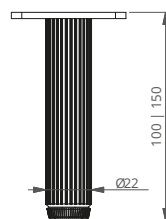
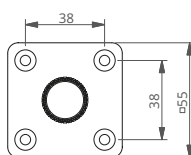

Z-4619

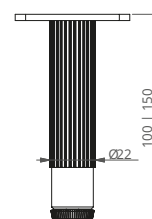

Z-4620

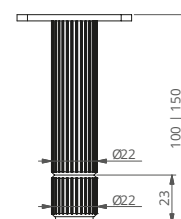

Z-4621







## Avanti

al/st

index	H	P
Z-4622-150RA1	150	2

A2-P61  
anoda złota-czarny mat  
anodized gold-black matt

A10-P61  
anoda czarna-czarny mat  
anodized black-black matt

G2-P61  
chrom połysk-czarny mat  
glossy chrome-black matt

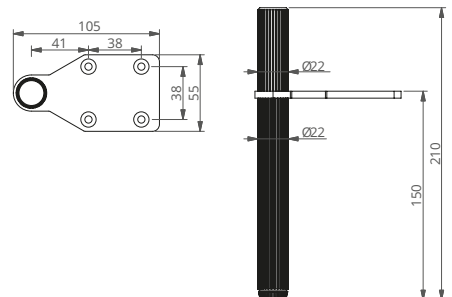

## Sempre

st

index	H	P
Z-4615-100	100	2
Z-4615-150	150	2
Z-4615-190	190	2

G2  
chrom połysk  
glossy chrome

G77  
złoto matowe czesane  
gold matt brushed

P61  
czarny mat  
black matt

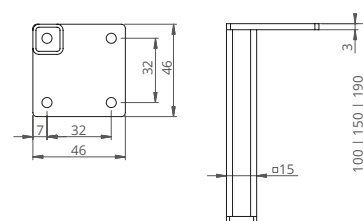

## Olin

st

index	H	P
Z-4613-348	348	2

P78  
srebrny mat  
silver mat

P94  
złoto  
gold

TL77  
złoto matowe  
gold matt

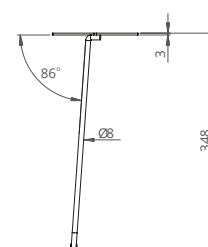

index	H	P
Z-4618-126	126	2

P61  
czarny mat  
black matt

P94  
złoto  
gold

TL77  
złoto matowe  
gold matt

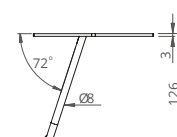





akcesoria dekoracyjne / decorative accessories



Prato nogi stolika kawowego - set  
Prato coffe table legs - set

index	W	H	P
Z-6891.P61	600	400	1

P61  
czarny mat  
black matt

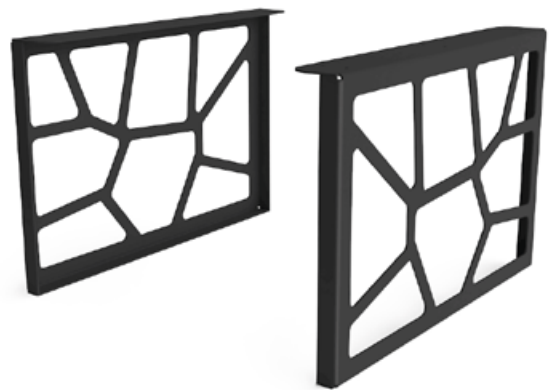



## Verso półka Verso shelf

st

index	W	H	P
Z-6893L.P67	350	100	1
Z-6893L.P68	350	100	1
Z-6893P.P67	350	100	1
Z-6893P.P68	350	100	1

P67  
kość słoniowa  
ivory

P68  
antracyt  
anthracite





## Magnetic wall - set

st

index	W	H	P
Z-6892.P67	544	338	1
Z-6892.P68	544	338	1

P67  
kość słoniowa  
ivory

P68  
antracyt  
anthracite

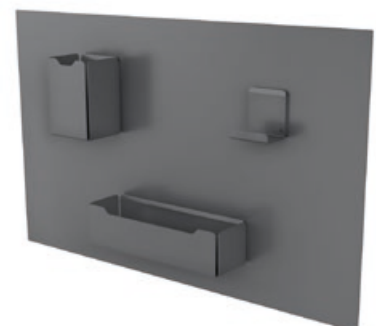



## Tablica Wall

st

index	W	H	P
Z-6892-01.P67	544	338	1
Z-6892-01.P68	544	338	1

P67  
kość słoniowa  
ivory

P68  
antracyt  
anthracite

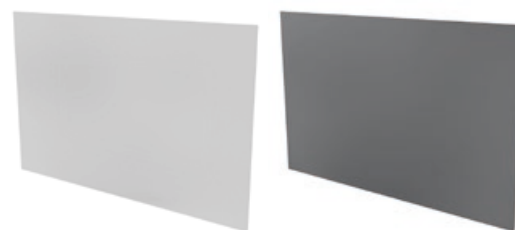

## Wieszak magnetyczny Magnetic hanger

st

index	W	H	P
Z-6892-02.P67	50	55	1
Z-6892-02.P68	50	55	1

P67  
kość słoniowa  
ivory

P68  
antracyt  
anthracite



## Półka pionowa magnetyczna Magnetic vertical shelf

st

index	W	H	P
Z-6892-03.P67	70	100	1
Z-6892-03.P68	70	100	1

P67  
kość słoniowa  
ivory

P68  
antracyt  
anthracite



## Półka pozioma magnetyczna Magnetic horizontal shelf

st

index	W	H	P
Z-6892-04.P67	205	55	1
Z-6892-04.P68	205	55	1

P67  
kość słoniowa  
ivory

P68  
antracyt  
anthracite

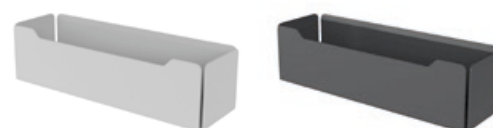

## A

### powłoka anodowana anodized finish



**A1**  
anoda naturalna  
anodized natural



**A2**  
anoda złota  
anodized gold



**A8**  
stal szlachetna  
stainless steel

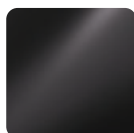

**A10**  
anoda czarna  
anodized black



**A10S**  
anoda czarna szczotkowana  
anodized black brushed



**A11**  
anoda szczotkowana  
anodized brushed

## G

### powłoka galwaniczna galvanic finish



**G2**  
chrom połysk  
glossy chrome



**G3**  
złoty połysk  
glossy gold



**G4**  
patyna na miedzi  
antique brass



**G5**  
nikiel mat  
nickel matt



**G6**  
chrom mat  
chrome matt

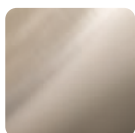

**G8**  
stal szlachetna  
stainless steel

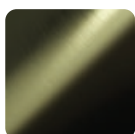

**G10A**  
patyna na miedzi  
czesana na krawędziach  
black nickel on brass  
brushed on edges



**G10M**  
patyna na miedzi  
antique brass

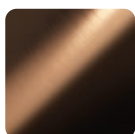

**G20A**  
patyna na miedzi  
czesana na krawędziach  
black nickel on copper  
brushed on edges

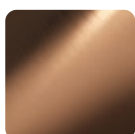

**G20M**  
patyna na miedzi  
antique copper

## G

### powłoka galwaniczna galvanic finish



**G35, G35M**  
srebro postarzone  
old silver



**G49**  
cyna postarzana  
old tin



**G70**  
miedź czesana  
copper brushed



**G71**  
stary nikiel  
old nickel



**G72**  
tytan  
titanium



**G73**  
stara miedź  
old copper



**G74**  
stary miedź  
old brass



**G77**  
złoto matowe czesane  
gold matt brushed

**P** lakier proszkowy  
powder coating



**P1**  
biały  
white



**P2**  
czarny  
black



**P59**  
czarny połysk  
glossy black



**P60**  
biały połysk  
glossy white



**P61**  
czarny mat  
black matt



**P67**  
kość słoniowa  
ivory



**P68**  
antracyt  
anthracite

**T** tworzywo sztuczne  
plastic



**T1**  
biały  
white



**T10**  
czarny  
black



**T37**  
niebieski  
blue



**T38**  
biały  
white



**T39**  
czerwony  
red



**T40**  
pomarańczowy  
orange



**T41**  
kość słoniowa  
ivory

**TL** powłoka lakierowana  
lacquered finish



**TL20**  
miedź  
copper



**TL33**  
pastelowy beżowy  
pastel beige



**TL34**  
pastelowy różowy  
pastel pink



**TL35**  
pastelowy błękit  
pastel blue



**TL36**  
pastelowy zielony  
pastel green



**TL77**  
złoto matowe  
gold matt

**SS** stal szlachetna  
stainless steel



**SS**  
stal szlachetna  
stainless steel

**RA** struktury  
structures



**RA1**  
liniowa  
linear

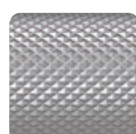

**RA2**  
krzyżkowa  
crossed

## Oznaczenia / symbols

- A – gałka / knob  
 C – uchwyt / handle  
 D – uchwyt kołatka / handle-knocker  
 Z – wieszak / hook
- S – rozstaw otworów (mm) / hole spacing (mm)  
 Ø – średnica (mm) / diameter (mm)  
 W – szerokość (mm) / width (mm)  
 H – wysokość (mm) / height (mm)  
 L – długość (mm) / length (mm)  
 P – pakowanie (ilość szt.) / number of pieces packed

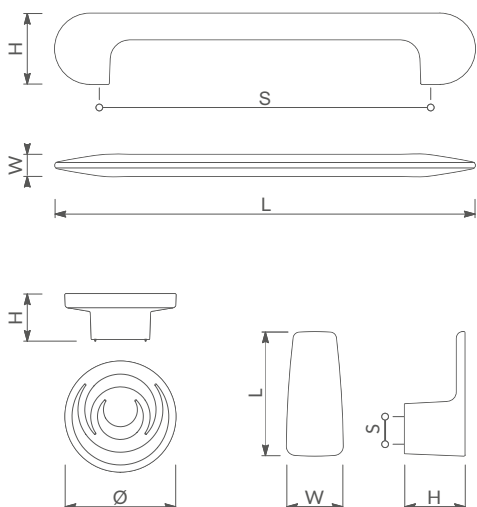

## Materiał / material

- al - aluminium / aluminum  
 plst - tworzywo sztuczne / plastic  
 st - stal / steel  
 znal - ZnAl / zinc-aluminum alloy

## Rodzaj pokrycia / type of coating

- A – powłoka anodowana / anodized finish  
 G – powłoka galwaniczna / galvanic finish  
 P – lakier proszkowy / powder coating  
 TL - powłoka lakierowana / lacquered finish

Niniejszy katalog jest wyłącznie materiałem reklamowym nie stanowiącym oferty handlowej w rozumieniu art. 66 Kodeksu Cywilnego. Producent zastrzega sobie prawo do wycofania niektórych produktów z oferty oraz wprowadzania zmian technicznych produktów. Nie ponosimy odpowiedzialności za błędy drukarskie. Prawa autorskie do katalogu są zastrzeżone. Bez pisemnej zgody nie ma możliwości kopiowania katalogu w całości ani w jakiegokolwiek innej formie.

This is the advertising material which does not constitute an offer within the meaning of art. 66 of the Civil Code. We reserve the right to withdraw certain products included in the offer. We reserve the right to make technical changes. No liability for printing errors or mistakes. In relation to this catalog we reserve the copyright. Without our written permission is prohibited to copy the catalog in any form either in whole or in a part.

## Spis treści wg indeksu / contents by index

A-013	145	A-955	183
A-025	145	A-995A	172
A-077A	147	A-995A	182
A-1014	142	A-995A	186
A-1053	143	B-070	144
A-1135	136	B-090	145
A-1234	141	B-100	45
A-1272	150	B-150	144
A-1294	137	B-160	137
A-1313	151	C-074	134
A-1393	142	C-094RA2	84
A-1405	155	C-094ST	86
A-1415	155	C-095RA2	84
A-1425	154	C-095ST	86
A-1434	47	C-096RA2	84
A-1455	152	C-096ST	86
A-1465	153	C-099-320RA2	84
A-1503	148	C-099-320ST	86
A-1522	36	C-1003	101
A-1532	39	C-1083	130
A-1542	191	C-1084	130
A-1552	37	C-1093	130
A-1552	193	C-1094	130
A-1562	140	C-1103	130
A-1572	33	C-1104	130
A-1602	51	C-1143	114
A-1626RA2	18	C-1144	114
A-1636	12	C-1145	114
A-1646RA1	7	C-1146	114
A-1646RA1	9	C-1148	114
A-1656RA2	18	C-1149-320	114
A-1672RA2	11	C-1553	99
A-1682RA2	17	C-1654	81
A-1692RA2	17	C-1655	81
A-246	149	C-173A	133
A-256	143	C-174	133
A-264	150	C-1743	132
A-312	148	C-1751	136
A-325	147	C-1753	136
A-400	149	C-1755	136
A-464	150	C-1760-148	167
A-743	141	C-1760-212	167
A-763	150	C-1760-340	167
A-823	146	C-1770-148	169
A-955	126	C-1770-180	169

C-1770-212	169	C-2123	130	C-3488	108
C-1770-276	169	C-2124	130	C-3489-320	108
C-1770-340	169	C-2331	129	C-3504	123
C-1881	119	C-2360-148	166	C-3505	123
C-1882	119	C-2360-180	166	C-3506	123
C-1883	119	C-2360-212	166	C-3590-1096	158
C-1891	126	C-2360-276	166	C-3590-1196	158
C-1892	126	C-2360-340	166	C-3590-146	158
C-192	95	C-2701	128	C-3590-196	158
C-1973	98	C-293	99	C-3590-246	158
C-1983	99	C-2943	101	C-3590-296	158
C-2020-148	169	C-2951	115	C-3590-346	158
C-2020-180	169	C-2954	115	C-3590-396	158
C-2020-212	169	C-2955	115	C-3590-446	158
C-2020-276	169	C-2957	115	C-3590-496	158
C-2020-340	169	C-2958	115	C-3590-596	158
C-2044	134	C-2959-320	115	C-3590-696	158
C-2050-148	167	C-3014N	68	C-3590-796	158
C-2050-180	167	C-3015N	68	C-3590-896	158
C-2050-212	167	C-3031	127	C-3590-996	158
C-2050-276	167	C-3042	127	C-3634	38
C-2050-340	167	C-3052	44	C-3710	151
C-2100-156	135	C-3074	134	C-3711	151
C-2100-188	135	C-3076	134	C-3809-128	90
C-2100-188RA2	67	C-3135	117	C-3809-160	90
C-2100-208	135	C-3137	117	C-3809-192	90
C-2100-220	135	C-313A	131	C-3809-224	90
C-2100-220RA2	67	C-314	131	C-3809-256	90
C-2100-240	135	C-3147	117	C-3809-320	90
C-2100-272	135	C-3159-398	74	C-3809-384	90
C-2100-272RA2	67	C-3159A-1024	74	C-3814	110
C-2100-304	135	C-3159B-1024	74	C-3815	110
C-2100-356	135	C-3232	129	C-3816	110
C-2100-368	135	C-3264	47	C-3818	110
C-2100-400	135	C-3274	109	C-3819-320	110
C-2100-400RA2	67	C-3278	109	C-3824	111
C-2100-432	135	C-3314	94	C-3825	111
C-2100-464	135	C-3318	94	C-3826	111
C-2100-496	135	C-3374	134	C-3827	111
C-2100-528	135	C-3444	101	C-3828	111
C-2100-560	135	C-3475	112	C-3829-320A	111
C-2100-592	135	C-3479-320	112	C-3839Z-128	118
C-2100-624	135	C-3484	108	C-3839Z-160	118
C-2100-656	135	C-3485	108	C-3839Z-192	118
C-2100-752	135	C-3486	108	C-3839Z-224	118

Spis treści wg indeksu / contents by index

C-3839Z-320	118	C-4519Z-128	94	C-5055	107
C-3839Z-416/450	118	C-4565	94	C-5065	83
C-4005	94	C-4789A-126	162	C-5069-320	83
C-4089Z-128	119	C-4789A-158	162	C-5074	106
C-4089Z-160	119	C-4789A-190	162	C-5075	106
C-4089Z-192	119	C-4789A-222	162	C-5080-148	166
C-4089Z-320	119	C-4789A-286	162	C-5080-180	166
C-4089Z-96	119	C-4789A-350	162	C-5080-212	166
C-4132	124	C-4789A-94	162	C-5080-276	166
C-4134	124	C-4909A-126	160	C-5080-340	166
C-4189-128	91	C-4909A-158	160	C-5101	40
C-4189-160	91	C-4909A-190	160	C-5104	40
C-4189-192	91	C-4909A-222	160	C-5111	41
C-4189-320	91	C-4909A-286	160	C-5114	41
C-4409-128	90	C-4909A-350	160	C-5121	125
C-4409-160	90	C-4909A-94	160	C-5124	125
C-4409-192	90	C-5000A-158	161	C-5149-160	88
C-4409-320	90	C-5000A-158-R10	161	C-5149-256	88
C-4414	111	C-5000A-190	161	C-5149-320	88
C-4415	111	C-5000A-190-R10	161	C-5180	43
C-4419-320	111	C-5000A-222	161	C-5183	43
C-4429-128	89	C-5000A-222-R10	161	C-5184	43
C-4429-160	89	C-5000A-286	161	C-5185	43
C-4429-192	89	C-5000A-286-R10	161	C-5193	39
C-4429-320	89	C-5000A-350	161	C-5195	39
C-4435	113	C-5000A-350-R10	161	C-5265	37
C-4469-128	91	C-5010-148	168	C-5265	193
C-4469-160	91	C-5010-180	168	C-5275	103
C-4469-192	91	C-5010-212	168	C-5285	120
C-4469-320	91	C-5010-276	168	C-5286	120
C-4474	105	C-5010-340	168	C-5289-320	120
C-4475	105	C-5020-148	165	C-5293	122
C-4476	105	C-5020-180	165	C-5295	122
C-4478	105	C-5020-212	165	C-5305	113
C-4484	105	C-5020-276	165	C-5324	119
C-4485	105	C-5020-340	165	C-5361	129
C-4486	105	C-503	133	C-5370-148	168
C-4489-320	105	C-5039-128	36	C-5370-180	168
C-4495	107	C-5039-160	36	C-5370-212	168
C-4498	107	C-5039-192	36	C-5370-276	168
C-4509-128	87	C-5039-224	36	C-5370-340	168
C-4509-160	87	C-5039-256	36	C-5439-1024/1135A	79
C-4509-192	87	C-5039-320	36	C-5439-1028/1135	79
C-4509-320	87	C-504A	133	C-5455	93
C-451	128	C-5053	107	C-5458	93

C-5459-320	93	C-5810-340/320	164	C-6239-192	62
C-5509-128	88	C-5810-92/64	164	C-6239-192RA1	63
C-5509-160	88	C-5821	49	C-6239-192RA2	63
C-5509-192	88	C-5823	49	C-6239-320	62
C-5509-320	88	C-5824	49	C-6239-320RA1	63
C-5519A-158	163	C-5825	49	C-6239-320RA2	63
C-5519A-190	163	C-5826	49	C-624	131
C-5519A-222	163	C-5828	49	C-6249-192	64
C-5519A-286	163	C-5829-320	49	C-6249-192RA1	65
C-5519A-350	163	C-5829-416	49	C-6249-192RA2	65
C-5539A-158	163	C-5834	102	C-6249-320	64
C-5539A-190	163	C-5836	102	C-6249-320RA1	65
C-5539A-222	163	C-5838	102	C-6249-320RA2	65
C-5539A-286	163	C-5839-320	102	C-6259-120	20
C-5539A-350	163	C-5849-160	71	C-6259-120	24
C-5579-1024/1135	79	C-5849-192	71	C-6259-32	20
C-5634	82	C-5849-256	71	C-6259-32	24
C-5645	121	C-5849-320	71	C-6269-120	21
C-5649-320	121	C-5875Z	103	C-6269-120	25
C-5705	80	C-5923	81	C-6269-32	21
C-5711	35	C-5929-320	81	C-6269-32	25
C-5715	35	C-6171	30	C-6279-32	23
C-5725	33	C-6173	31	C-6279-32	27
C-5729-320	33	C-6193	54	C-6449-160RA2	19
C-5750-1096	159	C-6195	54	C-6449-320RA2	19
C-5750-1196	159	C-6219-160	58	C-6463	13
C-5750-146	159	C-6219-160RA1	59	C-6476	70
C-5750-196	159	C-6219-160RA2	59	C-6479-320	70
C-5750-246	159	C-6219-192	58	C-6483	54
C-5750-296	159	C-6219-192RA1	59	C-6485	54
C-5750-346	159	C-6219-192RA2	59	C-6489-320	54
C-5750-396	159	C-6219-320	58	C-6493	55
C-5750-446	159	C-6219-320RA1	59	C-6495	55
C-5750-496	159	C-6219-320RA2	59	C-6499-320	55
C-5750-596	159	C-622	131	C-6515	69
C-5750-696	159	C-6229-160	60	C-6516	69
C-5750-796	159	C-6229-160RA1	61	C-6519-320	69
C-5750-896	159	C-6229-160RA2	61	C-6541RA1	7
C-5750-996	159	C-6229-192	60	C-6541RA1	9
C-5769-1135/352	77	C-6229-192RA1	61	C-6562	15
C-5769-1135A/352	77	C-6229-192RA2	61	C-6729-192RA2	57
C-5769-394/352	73	C-6229-320	60	C-6729-320RA2	57
C-5769-522/352	73	C-6229-320RA1	61	C-6739-192	57
C-5779-348/320	169	C-6229-320RA2	61	C-6739-320	57
C-5779-92/64	169	C-623	131	C-6749-192RA2	17

Spis treści wg indeksu / contents by index

C-6749-320RA2	17	Z-5421	43	Z-6893P.P67	207
C-6759-1056RA1	75	Z-5421	184	Z-6893P.P68	207
C-6759-416RA1	75	Z-5423	191	Z-6909	15
C-713	133	Z-5423A	187	Z-6913-1000.P61	199
C-714	133	Z-5423A	191	Z-6913-1000.P94	199
C-962	128	Z-5426	174	Z-6913-1000.TL77	199
D-023	97	Z-5430	35	Z-6913-600.P61	199
D-033	97	Z-5431	23	Z-6913-600.P94	199
D-062	45	Z-5431	27	Z-6913-600.TL77	199
D-168	97	Z-5434	29	Z-6913-800.P61	199
E-370	45	Z-5435RA1	7	Z-6913-800.P94	199
E-450	145	Z-5435RA1	9	Z-6913-800.TL77	199
E-460	145	Z-5436	184		
E-580	143	Z-5437	185		
Z-341	178	Z-5438	183		
Z-355	178	Z-5439	187		
Z-361	177	Z-5440	186		
Z-375	177	Z-5441	186		
Z-391	173	Z-5442	182		
Z-422	173	Z-5444	189		
Z-423	173	Z-5445	189		
Z-6913-001	199	Z-5445-680	188		
Z-4613-348	203	Z-5445A-590	189		
Z-4615-100	203	Z-5447RA2	11		
Z-4615-150	203	Z-6806	195		
Z-4615-190	203	Z-6811-203	195		
Z-4618-126	203	Z-6814-680	194		
Z-4619-100RA1	200	Z-6823	191		
Z-4619-150RA1	200	Z-6823-680	190		
Z-4620-100RA1	200	Z-6823A-590	191		
Z-4620-150RA1	200	Z-6827-700	194		
Z-4621-100RA1	200	Z-6841A-590	193		
Z-4621-150RA1	200	Z-6891.P61	206		
Z-4622-150RA1	202	Z-6892-01.P67	209		
Z-5309-680	192	Z-6892-01.P68	209		
Z-5309A-590	192	Z-6892-02.P67	209		
Z-5401	175	Z-6892-02.P68	209		
Z-5402	175	Z-6892-03.P67	209		
Z-5408	179	Z-6892-03.P68	209		
Z-5409	44	Z-6892-04.P67	209		
Z-5412	172	Z-6892-04.P68	209		
Z-5413	47	Z-6892.P67	208		
Z-5415	38	Z-6892.P68	208		
Z-5419-400	181	Z-6893L.P67	207		
Z-5420-400	181	Z-6893L.P68	207		



Spis treści wg nazwy / contents by name

Afrodyta	150	Clio	98	Lahti	134
Aksis	36	Costa	162	Lana	79
Alambre	60, 61	Crudo	194	Latino	169
Altare	39	Cruso	67	Lavice	90
Alternative	109	Daina	129	Leda	45
Altro	151	Dante	181	Left Field	117
Alvero	187, 190, 191	Deep	179	Letto	83
Amaro	120	Demeter	145	Liberc	137
Ambient	148	Diuna	140	Libretto	43, 184
Andare	159	Dominica	173	Libro	107
Andora	81	Dublin	68	Linea	70
Ansa	101	Dubstep	119	Louisiana	172
Antago	195	Encato	90	Lounge	74
Apro	73, 77	Enel	105	Magnetic wall - set	208
Arco	131	Enzo	71	Makao	167
Argus	131	Eren	199	Malta	167
Argus	178	Essen	169	Mars	145
Aris	94	Fado	166	Marsias	141
Armado	113	Fede	103	Milan	149
Arno	75	Ferro	81	Monaco	134
Ars Nova	152	Fibbia	111	Mondo	18, 19
Arto	174	Fiore	41	Napoli	147
Ashema	95	Fivela	94	Natale	58, 59
Aspro	195	Fondo	129	Noak	105
Asser	94	Fornax	130	Nogi ze stelażem Eren – kpl. Legs with frame Eren – set	199
Asti	192	Fresco	91	Nolan	163
Astro	148	Frotto	118	Nyja	99
Avanti	7, 9, 200, 202	Fuga	117	Olin	203
Avere	168	Galium	84,86	Olivia	133
Bachus	101	Galway	132	Ondin	57
Baleno	119	Georgia	133	Ontario	173
Baltic	128	Golden Gate	112	Ordo	113
Big Beat	153	Greta	11	Pablo	88
Blues	151	Grime	154	Pallada	150
Caldo	40	Hermes	69	Pasto	128
Calypso	155	Hestia	145	Pectus	111
Campana	49, 51, 188, 189	Highway	158	Pero	88
Caracas	129	Hino	144	Perseus	143
Carlo	147	House	115	Piano	123
Cartagena	172, 186	Ikar	142	Pinus	143
Celebes	177	Jazz	127	Plymouth	128
Celer	136	Kronos	99	Ponti	181
Cerber	99	La Paz	133	Porto	134
Cert	57	Lago	29		
Chorus	44	Lago	30,31		

## Spis treści wg nazwy / contents by name

Półka pionowa magnetyczna Magnetic vertical shelf	209	Terra	161
Półka pozioma magnetyczna Magnetic horizontal shelf	209	Terra Pro	161
Prato	54, 182	Tiara	62, 63
Prato ażurowe asymetryczne Prato openwork unsymmetric	55	Tiro	168
Prato ażurowe symetryczne Prato openwork symmetric	54	Tonga	163
Prato nogi stolika kawowego – set Prato coffe table legs – set	206	Torn	20-27
Preso	80	Toronto	146
Prestige	89	Torre	102
Pronus	119	Tribal	134
Pumpin	127	Trip Hop	155
Quadrum	136	Twix	93
Rahim	97	Vea	107
Redo	185	Veleno	166
Reggae	150	Vena	165
Regulus	130	Vende	17
Remo	64, 65	Vera	160
Rene	97	Verba	164
Ricato	121	Verico	122
Rotto	103	Verne	106
Rustico	110	Verso półka Verso shelf	207
Salix	38	Victoria	130
Santa Cruz	135	Vigor	91
Sartre	169	Vinella	137
Sea	15	Virgo	15, 130
Sedin	141	Virtus	97
Sempre	203	Viva	87
Sid	35	Wega	12, 13
Silen	194	Wieszak magnetyczny Magnetic hanger	209
Ska	126, 183	Wood	82
Soho	144	Yukon	177
Sol	175	Zeus	101
Solde	33		
Solea	124		
Songo	108		
Sparta	47		
Strada	125		
Sydney	149		
Tablica Wall	209		
Tanza	142		
Tavolo	37, 193		
Techno	114		
Teres	94		

*... z pasji do wnętrza*

# nomet



*... z pasji do wnętrz*



Website  
[www.nomet.pl](http://www.nomet.pl)



Find us on Facebook  
[@nometpoland](https://www.facebook.com/nometpoland)



Follow us on Instagram  
[@inspiracjenomet](https://www.instagram.com/inspiracjenomet)