

indice Articoli

<i>Seicento</i>	<i>PAG. 204</i>
<i>700 Inglese</i>	<i>PAG. 206</i>
<i>Art Dèco</i>	<i>PAG. 210</i>
<i>Art & Crafts</i>	<i>PAG. 214</i>
<i>Art Dèco</i>	<i>PAG. 222</i>
<i>Arte Povera</i>	<i>PAG. 242</i>
<i>Barocco</i>	<i>PAG. 252</i>
<i>Chippendale</i>	<i>PAG. 260</i>
<i>Coloniale</i>	<i>PAG. 262</i>
<i>Neoclassico</i>	<i>PAG. 268</i>
<i>Country</i>	<i>PAG. 284</i>
<i>Decorativo</i>	<i>PAG. 286</i>
<i>Directoire</i>	<i>PAG. 291</i>
<i>Arts & Crafts</i>	<i>PAG. 294</i>
<i>Grunderzeit</i>	<i>PAG. 298</i>
<i>Heppeliwhite</i>	<i>PAG. 300</i>
<i>Impero</i>	<i>PAG. 306</i>
<i>Jugendstil</i>	<i>PAG. 309</i>
<i>Liberty</i>	<i>PAG. 312</i>
<i>Luigi XV</i>	<i>PAG. 328</i>
<i>Luigi XVI</i>	<i>PAG. 337</i>
<i>Provenzale</i>	<i>PAG. 360</i>
<i>Regency</i>	<i>PAG. 362</i>
<i>Rustico</i>	<i>PAG. 375</i>
<i>Marina</i>	<i>PAG. 382</i>
<i>Vittoriano</i>	<i>PAG. 384</i>
<i>Maniglie per vassoi / Tray handles</i>	<i>PAG. 386</i>
<i>Ferro</i>	<i>PAG. 388</i>

Stile

Seicento

Serie realizzabile in tutte le finiture indicate a catalogo / Series available in all finishes in the catalogue.

Seicento

Serie realizzabile in tutte le finiture indicate a catalogo / Series available in all finishes in the catalogue.

Finitura / Finish: 03 - Ottone antico / Antique brass

Finitura / Finish: 07 - Oro di Valenza



03020.07600.03



03020.06400.03

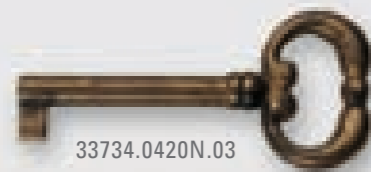

33734.0420N.03



30682.058V0.03



24499.04001.03



24499Z03500.03



24499Z03000.03



24499Z02500.03



03023.12800.07



03023.09600.07



21379.06100.07

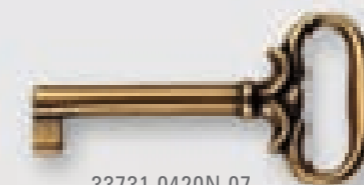

33731.0420N.07



30614.071V0.07



24477Z03000.07



24477Z02500.07



24477Z02000.07

CODICE Code	MISURE Overall size	INTERASSE C.to C.
03020.07600	104x56	76
03020.06400	84x47	64
24499.04001	40x34	Ø 40
24499Z03500	35x28	Ø 35
24499Z03000	30x24	Ø 30
24499Z02500	25x21	Ø 25

CODICE Code	MISURE Overall size	INTERASSE C.to C.
30682.058V0	38x58	-
33734.0530N	32x83	53
33734.0420N	32x72	42
33734.0340N	32x64	34

CODICE Code	MISURE Overall size	INTERASSE C.to C.
03023.12800	150x52	128
03023.09600	118x40	96
21379.06100	23x72	-
24477Z03000	30x23	Ø 30
24477Z02500	25x20	Ø 25
24477Z02000	20x18	Ø 20

CODICE Code	MISURE Overall size	INTERASSE C.to C.
30614.071V0	15x71	-
33731.0420N	35x69	42
33731.0340N	35x61	34

700 Inglese

Serie realizzabile in tutte le finiture indicate a catalogo / Series available in all finishes in the catalogue.

700 Inglese

Serie realizzabile in tutte le finiture indicate a catalogo / Series available in all finishes in the catalogue.

Finitura / Finish: 03 - Ottone antico / Antique brass

Finitura / Finish: 07 - Oro di Valenza



03019.11500.03

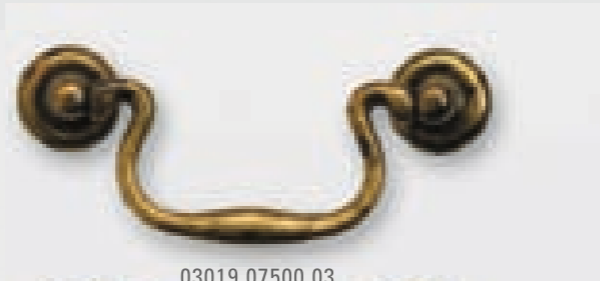

03019.07500.03



03019.09600.03



03019.06400.03



30611.082V0.03

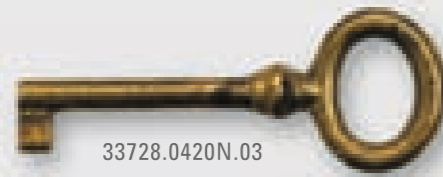

33728.0420N.03

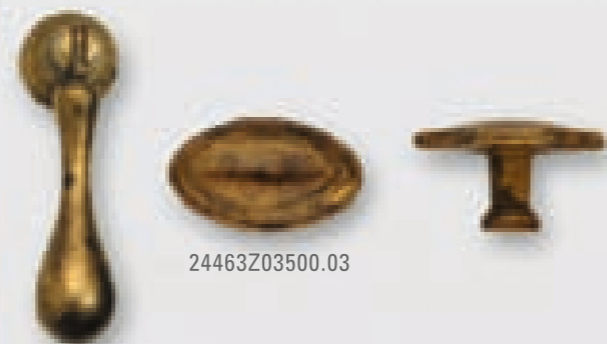

24463Z03500.03



30611.08200.03

21396.05300.03



24494Z03500.07



24494Z03000.07



24494Z02500.07



03028.09600.07



03028.06400.07

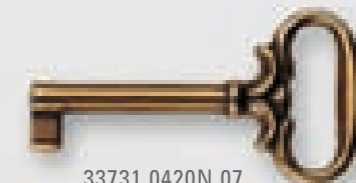

33731.0420N.07



30622.046V0.07

CODICE Code	MISURE Overall size	INTERASSE C.to C.
03019.11500	140x58	115
03019.09600	115x49	96
03019.07500	96x40	75
03019.06400	86x40	64
21396.05300	18x63	-
24463Z03500	35x20x22	-

CODICE Code	MISURE Overall size	INTERASSE C.to C.
30611.082V0	20x82	-
30611.08200	82x20	-
33728.0540N	29x88	54
33728.0420N	29x77	42
33728.0340N	29x69	34

CODICE Code	MISURE Overall size	INTERASSE C.to C.
03028.09600	124x51	96
03028.06400	89x41	64
24494Z03500	35x26	Ø 35
24494Z03000	30x24	Ø 30
24494Z02500	25x21	Ø 25
30622.046V0	20x46	-

CODICE Code	MISURE Overall size	INTERASSE C.to C.
33731.0420N	35x69	42
33731.0340N	35x61	34

700 Inglese

Serie realizzabile in tutte le finiture indicate a catalogo / Series available in all finishes in the catalogue.

700 Inglese

Serie realizzabile in tutte le finiture indicate a catalogo / Series available in all finishes in the catalogue.

Finitura / Finish: 07 - Oro di Valenza



Finitura / Finish: 07 - Oro di Valenza



CODICE Code	MISURE Overall size	INTERASSE C. to C.	CODICE Code	MISURE Overall size	INTERASSE C. to C.	CODICE Code	MISURE Overall size	INTERASSE C. to C.	CODICE Code	MISURE Overall size	INTERASSE C. to C.
03064.09600	118x46	96	33706.0240N	34x53	N 24	03027.09600	121x58	96	33708.0340N	35x64	34
03064.06400	80x34	64	33706.0340N	34x63	N 34	03027.06400	82x40	64	33708.0420N	35x70	42
21398.06200	22x73	-	33706.0380N	34x67	N 38	24487Z03500	35x30	Ø 35	33708.0530N	35x81	53
24406Z03500	35x26	Ø 35	33706.0420N	34x71	N 42	24487Z03000	30x27	Ø 30			
24406Z03000	30x24	Ø 30	33706.0530N	34x82	N 53	24487Z02500	25x24	Ø 25			
24406Z02500	25x21	Ø 25				30609.034V0.07	23x34	-			
30608.035V0	21x35	-									

Art Dèco

DESIGN: MARELLA DESIGN LAB

COMBINAZIONI DISPONIBILI: COMBINATION AVAILABLE:

ART DÉCO SENZA SMALTO - ART DÉCO WITHOUT ENAMEL

Available in finishes:

- 07 Oro di Valenza
- 09 Florence
- 19 Similferro / Similariron
- 25 Argento Vecchio / Old silver
- 29 Ramato antico / Antique copper



25

ART DÉCO CON SMALTO / ART DÉCO WITH ENAMEL

Available in finishes:

- 09 Florence - smalto bianco (A) / Florence - white enamel (A)
- 25 Argento vecchio - smalto bianco (A) / Old silver - white enamel
- 32 Nickel lucido - smalto bianco (A) / Bright nickel - white enamel



A32

Art Dèco

Serie realizzabile in tutte le finiture indicate a catalogo / Series available in all finishes in the catalogue.

Art Dèco con smalto/With enamel

Serie realizzabile in tutte le finiture indicate a catalogo / Series available in all finishes in the catalogue.

Finitura / Finish: 09 - Florence



15134Z12800.09



15134Z10000.09



24134Z07300.09



24134Z03000.09



Finitura / Finish: L09 - Florence con smalto champagne / Florence with champagne



15134Z12800L09



15134Z10000L09



24134Z07300L09



24134Z03000L09

CODICE Code	MISURE Overall size	INTERASSE C.to C.
15134Z12800	141x30	128
15134Z10000	102x34	64
24134Z07300	73x31x23	32
24134Z03000	30x22	Ø 30

CODICE Code	MISURE Overall size	INTERASSE C.to C.
15134Z12800	141x30	128
15134Z10000	102x34	64
24134Z07300	73x31x23	32
24134Z03000	30x22	Ø 30

Arts & Crafts

Serie realizzabile in tutte le finiture indicate a catalogo / Series available in all finishes in the catalogue.

Arts & Crafts

Serie realizzabile in tutte le finiture indicate a catalogo / Series available in all finishes in the catalogue.

Finitura / Finish: 09 - Florence



15146Z16000.09

15146Z12800.09

15146Z09600.09

Finitura / Finish: 09 - Florence



15144Z12800.09

15144Z09600.09

15144Z06400.09

15144Z03800.09

CODICE <i>Code</i>	MISURE <i>Overall size</i>	INTERASSE <i>C. to C.</i>
15146Z16000	198x32	160
15146Z12800	166x32	128
15146Z09600	134x32	96

CODICE <i>Code</i>	MISURE <i>Overall size</i>	INTERASSE <i>C. to C.</i>
15144Z12800	165x38	128
15144Z09600	131x38	96
15144Z06400	100x37	64
15144Z03800	38x36	-

Arts & Crafts

Serie realizzabile in tutte le finiture indicate a catalogo / Series available in all finishes in the catalogue.

Arts & Crafts

Serie realizzabile in tutte le finiture indicate a catalogo / Series available in all finishes in the catalogue.

Finitura / Finish: 25 - Argento vecchio / Old silver



06144Z09600.25

03144Z09600.25

Finitura / Finish: 09 - Florence



45144Z09000.09

15144Z10000.09

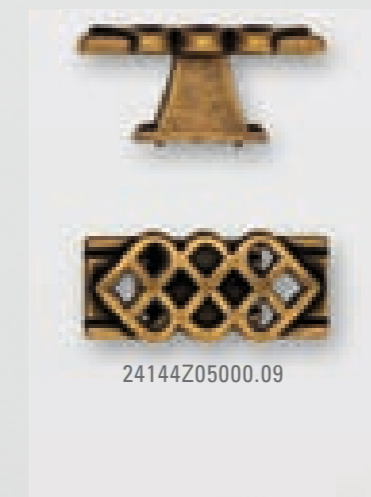

24144Z05000.09



30144Z090V0.09

CODICE <i>Code</i>	MISURE <i>Overall size</i>	INTERASSE <i>C. to C.</i>
06144Z09600	123x19	96
03144Z09600	109x44	96

CODICE <i>Code</i>	MISURE <i>Overall size</i>	INTERASSE <i>C. to C.</i>
15144Z10000	100x35	64
24144Z05000	50x23x19	-
30144Z090V0	22x90	-
45144Z09000	90x27	-

Arts & Crafts

Serie realizzabile in tutte le finiture indicate a catalogo / Series available in all finishes in the catalogue.

Arts & Crafts

Serie realizzabile in tutte le finiture indicate a catalogo / Series available in all finishes in the catalogue.

Finitura / Finish: 09 - Florence

Finitura / Finish: 09 - Florence



43144Z14600.09



43144Z17300.09



43144Z08100.09

CODICE Code	MISURE Overall size	INTERASSE C. to C.
43144Z14600	118x144	-

CODICE Code	MISURE Overall size	INTERASSE C. to C.
43144Z17300	81x175	-
43144Z08100	80x87	-

Finitura / Finish: 22 - Old America



Finitura / Finish: 25 - Argento vecchio / Old silver



Art Dèco

Serie realizzabile in tutte le finiture indicate a catalogo / Series available in all finishes in the catalogue.

Finitura / Finish: 07 - Oro di Valenza



15114Z12800.07



15114Z09600.07



15114Z06400.07

CODICE <i>Code</i>	MISURE <i>Overall size</i>	INTERASSE <i>C. to C.</i>
15114Z12800	183x17	128
15114Z09600	142x18	96
15114Z06400	99x13	64

Art Dèco

Serie realizzabile in tutte le finiture indicate a catalogo / Series available in all finishes in the catalogue.

Finitura / Finish: 07 - Oro di Valenza



15128Z12800.07



15128Z09600.07



15128Z06400.07

CODICE <i>Code</i>	MISURE <i>Overall size</i>	INTERASSE <i>C. to C.</i>
15128Z12800	140x18	128
15128Z09600	107x15	96
15128Z06400	73x11	64

Art Dèco

Serie realizzabile in tutte le finiture indicate a catalogo / Series available in all finishes in the catalogue.

Art Dèco

Serie realizzabile in tutte le finiture indicate a catalogo / Series available in all finishes in the catalogue.

Finitura / Finish: 07 - Oro di Valenza



15900.12800.07



15900.09600.07



15900.06400.07

Finitura / Finish: 03 - Ottone antico / Antique brass



18900.12800.03



18900.09600.03

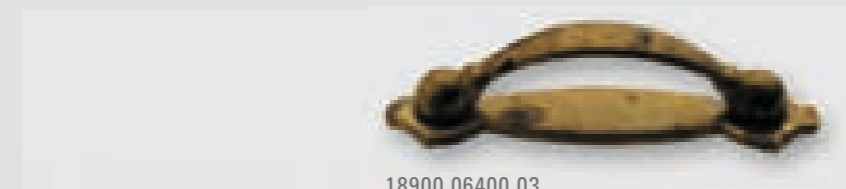

18900.06400.03

CODICE <i>Code</i>	MISURE <i>Overall size</i>	INTERASSE <i>C. to C.</i>
15900.12800	140x14	128
15900.09600	108x12	96
15900.06400	75x11	64

CODICE <i>Code</i>	MISURE <i>Overall size</i>	INTERASSE <i>C. to C.</i>
18900.12800	159x25	128
18900.09600	125x22	96
18900.06400	89x18	64

Art Dèco

Serie realizzabile in tutte le finiture indicate a catalogo / Series available in all finishes in the catalogue.

Art Dèco

Serie realizzabile in tutte le finiture indicate a catalogo / Series available in all finishes in the catalogue.

Finitura / Finish: 54 - Patinè bm



18330.18500.54

18330.12800.54

18330.09000.54

Finitura / Finish: 07 - Oro di Valenza



15129Z09600.07

15129Z06400.07

CODICE <i>Code</i>	MISURE <i>Overall size</i>	INTERASSE <i>C. to C.</i>
18330.18500	37x213	185
18330.12800	27x149	128
18330.09000	23x110	90

CODICE <i>Code</i>	MISURE <i>Overall size</i>	INTERASSE <i>C. to C.</i>
15129Z09600	120x17	96
15129Z06400	86x14	64

Art Dèco

Serie realizzabile in tutte le finiture indicate a catalogo / Series available in all finishes in the catalogue.

Art Dèco

Serie realizzabile in tutte le finiture indicate a catalogo / Series available in all finishes in the catalogue.

Finitura / Finish: 09 - Florence
03 - Ottone antico / Antique brass



Finitura / Finish: 09 - Florence
19 - Similferro / Similiron



CODICE <i>Code</i>	MISURE <i>Overall size</i>	INTERASSE <i>C.to C.</i>
15104.08500	27x85	-
15104.06000	27x60	-
15138.08000	26x80	-
15139.08000	26x80	-

CODICE <i>Code</i>	MISURE <i>Overall size</i>	INTERASSE <i>C.to C.</i>
15103Z09000	90x31	75
15203Z09000	90x31	75

Art Dèco

Serie realizzabile in tutte le finiture indicate a catalogo / Series available in all finishes in the catalogue.

Art Dèco

Serie realizzabile in tutte le finiture indicate a catalogo / Series available in all finishes in the catalogue.

Finitura / Finish: 03 - Ottone antico / Antique brass

Finitura / Finish: 03 - Ottone antico / Antique brass
11 - Ottone lucido / Polished brass



15122.09600.03



15123.08000.03



15122.07700.03

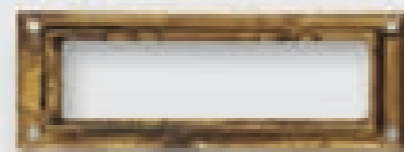

45123.08000.03



45125.07500.03



45124.07300.03



45125.07500.11



45124.07300.11

CODICE <i>Code</i>	MISURE <i>Overall size</i>	INTERASSE <i>C.to C.</i>
15122.09600	96x37	-
15122.07700	77x31	-
15123.08000	80x50	-
45123.08000	80x29	-

CODICE <i>Code</i>	MISURE <i>Overall size</i>	INTERASSE <i>C.to C.</i>
45124.07300	73x51	-
45125.07500	75x40	-

Art Dèco

Serie realizzabile in tutte le finiture indicate a catalogo / Series available in all finishes in the catalogue.

Art Dèco

Serie realizzabile in tutte le finiture indicate a catalogo / Series available in all finishes in the catalogue.

Finitura / Finish: 11 - Ottone lucido / Polished brass

Ottone / Brass

Finitura / Finish: 09 - Firenze

Zama / Zamak



15120.06400.11

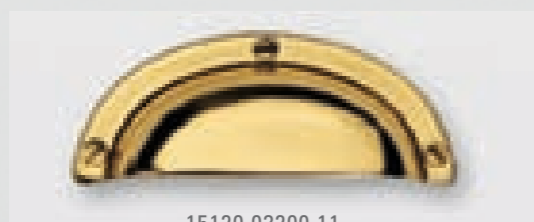

15120.03200.11



15120Z06400.09



15120Z03200.09

CODICE <i>Code</i>	MISURE <i>Overall size</i>	INTERASSE <i>C. to C.</i>
15120.06400	95x38	64
15120.03200	79x32	32

CODICE <i>Code</i>	MISURE <i>Overall size</i>	INTERASSE <i>C. to C.</i>
15120Z06400	95x38	64
15120Z03200	79x32	32

Finitura / Finish: DM - Watery stone

Finitura/Finish: D0 - Watery rust

Finitura / Finish: 12 - Ottone satinato / Satin brass

C.238

C.239

Stile

Stile



Art Dèco

Serie realizzabile in tutte le finiture indicate a catalogo / Series available in all finishes in the catalogue.

Art Dèco

Serie realizzabile in tutte le finiture indicate a catalogo / Series available in all finishes in the catalogue.

Finitura / Finish: 03 - Ottone antico / Antique brass



15121.08800.03



15121.07400.03

Finitura / Finish: 94 - Iron effect
19 - Similferro / Similiron
22 - Old America



15148Z10000.94



15125Z06400.19



15124Z06400.22

CODICE Code	MISURE Overall size	INTERASSE C. to C.
15121.08800	88x44	32
15121.07400	74x36	32

CODICE Code	MISURE Overall size	INTERASSE C. to C.
15148Z10000	102x34	64
15125Z06400	74x31	64
15124Z06400	72x26	64



Art Dèco

Serie realizzabile in tutte le finiture indicate a catalogo / Series available in all finishes in the catalogue.

Finitura / Finish: 03 - Ottone antico / Antique brass
19 - Similferro / Similiron



15332Z16200.03



15332Z09700.03



15332Z07800.03



15333Z08000.19

CODICE <i>Code</i>	MISURE <i>Overall size</i>	INTERASSE <i>C. to C.</i>
15332Z16200	162x37	96
15332Z09700	97x35	32
15332Z07800	78x32	32
15333Z08000	80x50	32

Arte povera

Serie realizzabile in tutte le finiture indicate a catalogo / Series available in all finishes in the catalogue.

Arte povera

Serie realizzabile in tutte le finiture indicate a catalogo / Series available in all finishes in the catalogue.

Finitura / Finish: 03 - Ottone antico / Antique brass



Finitura / Finish: 09 - Florence

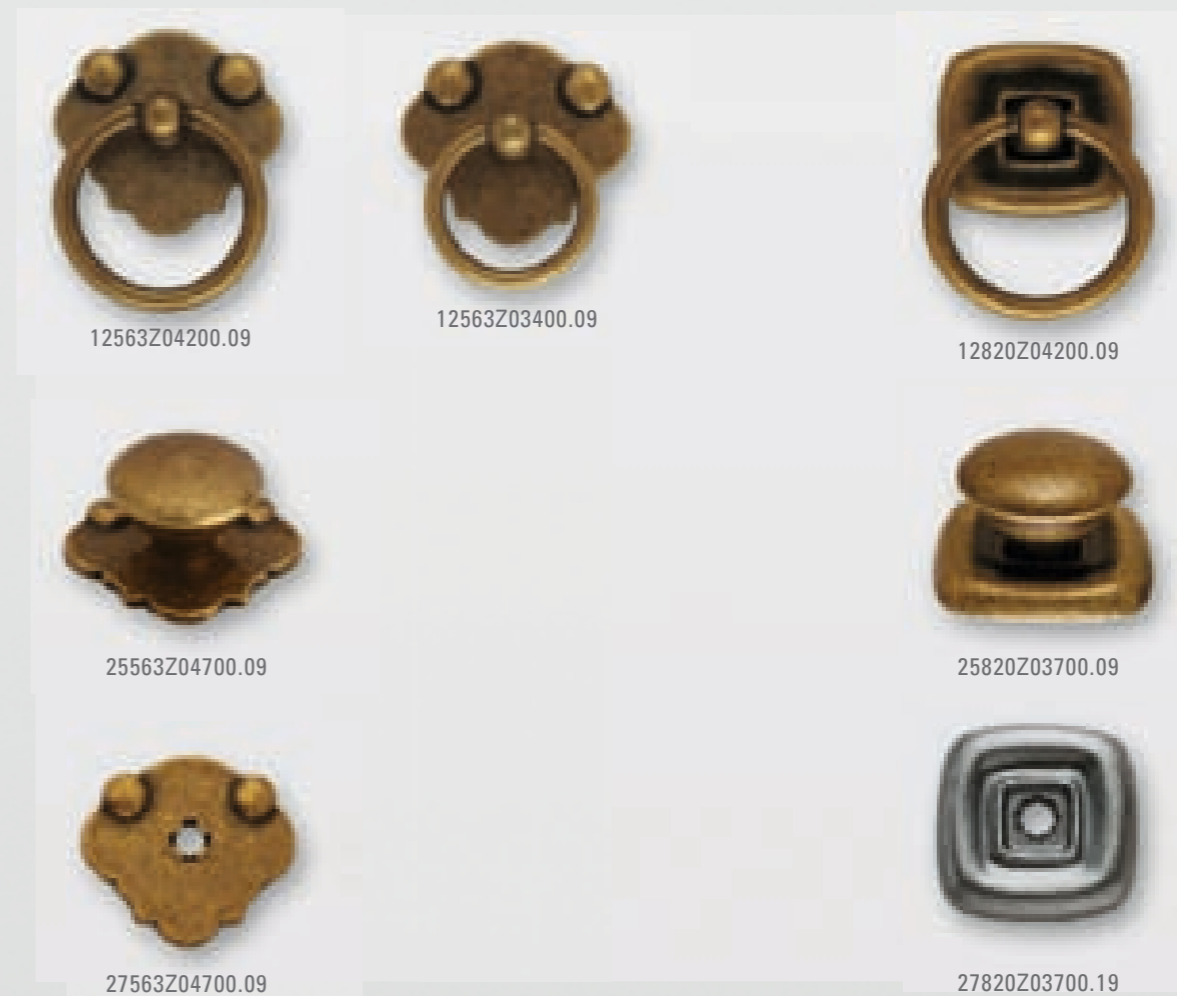

CODICE <i>Code</i>	MISURE <i>Overall size</i>	INTERASSE <i>C. to C.</i>
03070Z06400	88x38	64
09213Z05100	49x57	-
09213Z04200	43x52	-
09213Z03400	34x43	-
09216Z03400	34x50	-

CODICE <i>Code</i>	MISURE <i>Overall size</i>	INTERASSE <i>C. to C.</i>	CODICE <i>Code</i>	MISURE <i>Overall size</i>	INTERASSE <i>C. to C.</i>
12563Z04200	47x58	-	25563Z04700	47x42	-
12563Z03400	47x49	-	27820Z03700	39x39	-
12820Z04200	42x57	-	27563Z04700	47x42	-
25820Z03700	39x39	-			

Arte povera

Serie realizzabile in tutte le finiture indicate a catalogo / Series available in all finishes in the catalogue.

C.246

Stile

Finitura / Finish: 03 - Ottone antico / Antique brass



Arte povera

Serie realizzabile in tutte le finiture indicate a catalogo / Series available in all finishes in the catalogue.

C.247

Stile

Finitura / Finish: 03 - Ottone antico / Antique brass

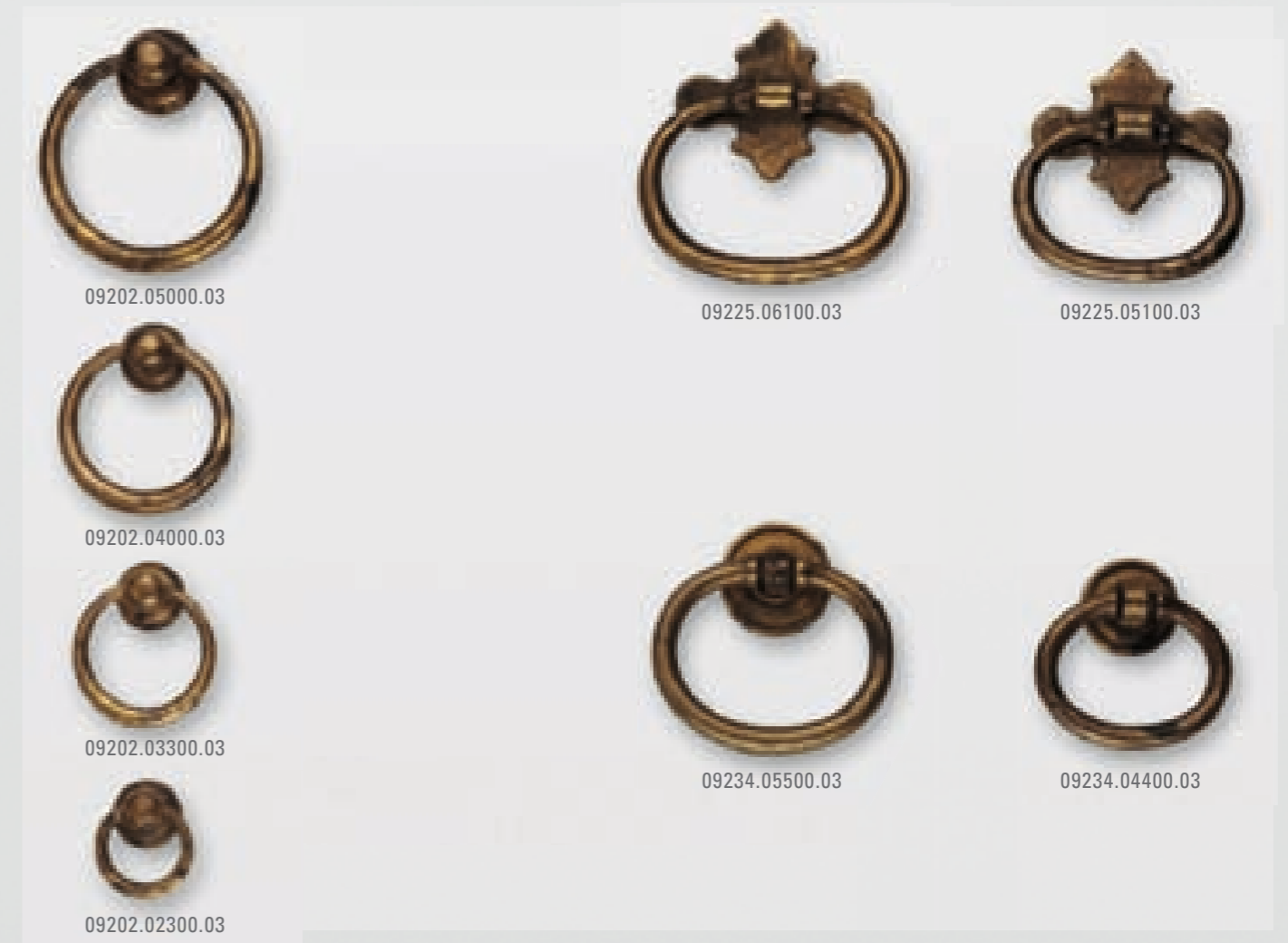

CODICE Code	MISURE Overall size	INTERASSE C.to C.
06309.06400	90x35	64
25105.09000	25x90	-
27564.09000	90x18	-
30637.090V0	18x90	-

CODICE Code	MISURE Overall size	INTERASSE C.to C.
09202.05000	50x57	-
09202.04000	40x46	-
09202.03300	33x39	-
09202.02300	23x28	-
09225.06100	61x61	32

CODICE Code	MISURE Overall size	INTERASSE C.to C.
09225.05100	51x54	32
09234.05500	55x55	-
09234.04400	44x45	-

Arte povera

Serie realizzabile in tutte le finiture indicate a catalogo / Series available in all finishes in the catalogue.

C.248

Stile

Finitura / Finish: 03 - Ottone antico / Antique brass



Arte povera

Serie realizzabile in tutte le finiture indicate a catalogo / Series available in all finishes in the catalogue.

C.249

Stile

Finitura / Finish: 03 - Ottone antico / Antique brass

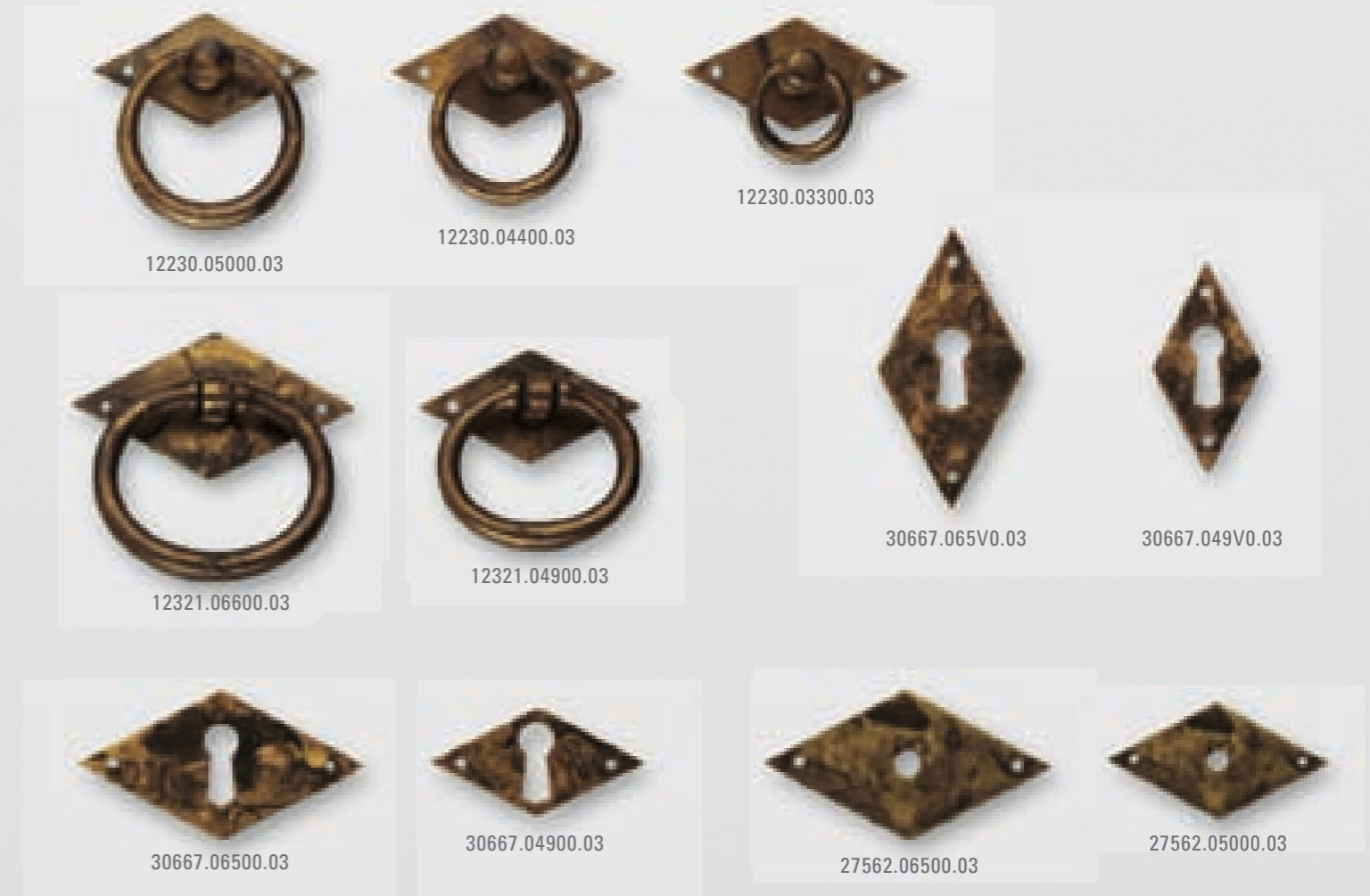

CODICE Code	MISURE Overall size	INTERASSE C. to C.
09208.05000	50x52	-
09208.04000	40x42	-
09208.03300	33x36	-
09208.02300	23x25	-
09226.06100	61x50	-
09226.05100	51x41	-

CODICE Code	MISURE Overall size	INTERASSE C. to C.
12230.05000	50x50	-
12230.04400	50x44	-
12230.03300	50x33	-
12321.06600	66x59	-
12321.04900	49x45	32
27562.06500	65x33	32

CODICE Code	MISURE Overall size	INTERASSE C. to C.
27562.05000	50x25	-
30667.065V0	34x65	-
30667.06500	65x34	-
30667.049V0	25x49	-
30667.04900	49x25	-

Arte povera

Serie realizzabile in tutte le finiture indicate a catalogo / Series available in all finishes in the catalogue.

Arte povera

Serie realizzabile in tutte le finiture indicate a catalogo / Series available in all finishes in the catalogue.

Finitura / Finish: 09 - Florence



06655Z09500.09



12655Z09500.09



12656Z09500.09

12656Z09501.09



12655Z06500.09

Finitura / Finish: 09 - Florence



25655Z09500.09



27655Z09500.09



25655Z06500.09



27655Z06500.09



30655Z06500.09



30655Z065V0.09

CODICE Code	MISURE Overall size	INTERASSE C. to C.
06655Z09500	95x42	64
12655Z09500	95x62	-
12655Z06500	65x45	-
12656Z09501	43x97	-
12656Z09500	43x97	-

CODICE Code	MISURE Overall size	INTERASSE C. to C.
25655Z09500	95x30	-
25655Z06500	65x25	-
27655Z09500	95x30	-
27655Z06500	65x24	-
30655Z065V0	24x65	-
30655Z06500	65x24	-

Arte povera

Serie realizzabile in tutte le finiture indicate a catalogo / Series available in all finishes in the catalogue.

Arte povera

Serie realizzabile in tutte le finiture indicate a catalogo / Series available in all finishes in the catalogue.

Finitura / Finish: 09 - Florence



Finitura / Finish: 09 - Florence



CODICE Code	MISURE Overall size	INTERASSE C.to C.
12712Z04200	91x55	-
12713Z03400	73x46	-
12714Z09100	91x31	-
12714Z07300	73x25	-

CODICE Code	MISURE Overall size	INTERASSE C.to C.
25714Z09100	91x31	-
25714Z07300	73x25	-
27714Z09100	91x31	-
27714Z07300	73x25	-
30714Z073V0	25x73	-

CODICE Code	MISURE Overall size	INTERASSE C.to C.
30714Z07300	73x25	-
30714Z091V0	31x91	-
30714Z09100	91x31	-

Barocco

Serie realizzabile in tutte le finiture indicate a catalogo / Series available in all finishes in the catalogue.

C.254

Stile

Finitura / Finish: 07- Oro di Valenza

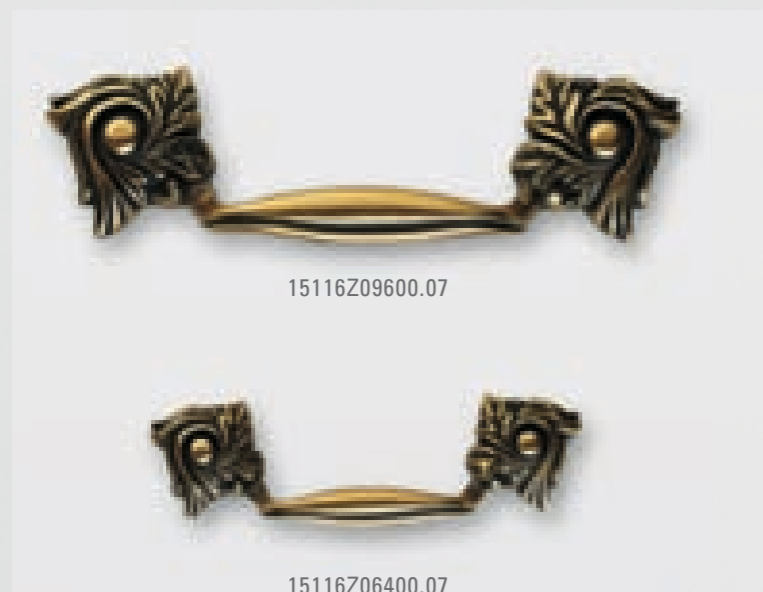

15116Z09600.07

15116Z06400.07



24224Z03000.07



24224Z02500.07

Barocco

Serie realizzabile in tutte le finiture indicate a catalogo / Series available in all finishes in the catalogue.

C.255

Stile

Finitura / Finish: 07- Oro di Valenza

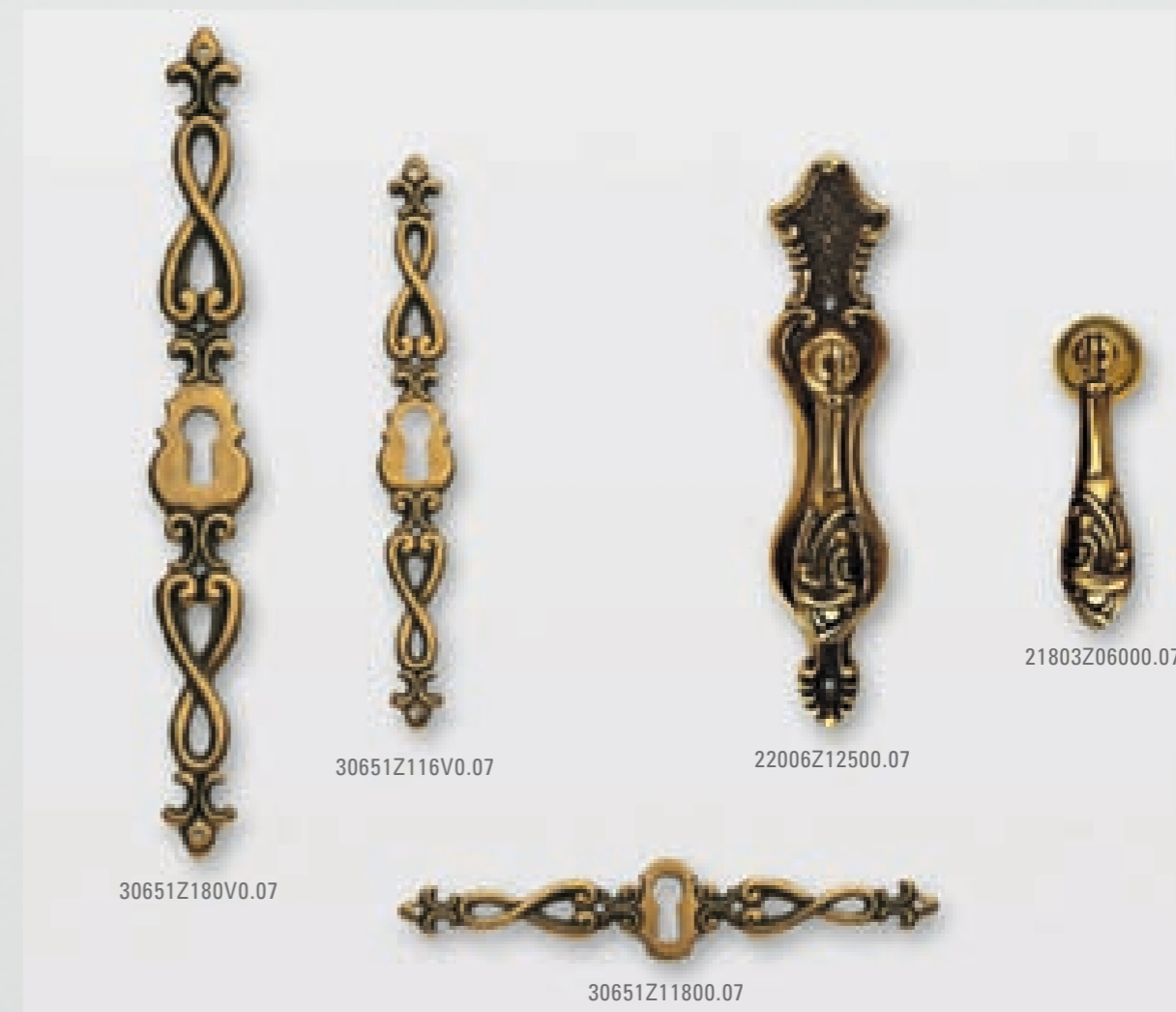

30651Z180V0.07

30651Z116V0.07

22006Z12500.07

21803Z06000.07

30651Z11800.07

CODICE Code	MISURE Overall size	INTERASSE C.to C.
15116Z09600	130x40	96
15116Z06400	88x27	64
24224Z03000	30x22	Ø 30
24224Z02500	25x20	Ø 25

CODICE Code	MISURE Overall size	INTERASSE C.to C.
21803Z06000	20x70	-
22006Z12500	28x125	-
30651Z116V0	17x125	-
30651Z11800	118x23	-
30651Z180V0	22x179	-

Barocco

Serie realizzabile in tutte le finiture indicate a catalogo / Series available in all finishes in the catalogue.

Finitura / Finish: 54 - Patinè bm



15074Z096S0.54

15074Z096D0.54

15074Z064S0.54

15074Z064D0.54

CODICE <i>Code</i>	MISURE <i>Overall size</i>	INTERASSE <i>C. to C.</i>
15074Z096S0	144x63	96
15074Z096D0	144x63	96
15074Z064S0	103x48	64
15074Z064D0	103x48	64



Barocco

Serie realizzabile in tutte le finiture indicate a catalogo / Series available in all finishes in the catalogue.

Finitura / Finish: 54 - Patinè bm

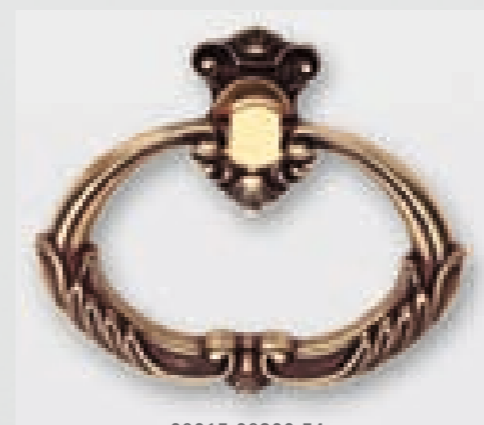

09015.08300.54



30631.062V0.54



24452Z03500.54



24452Z03000.54



09015.06200.54



30631.06200.54



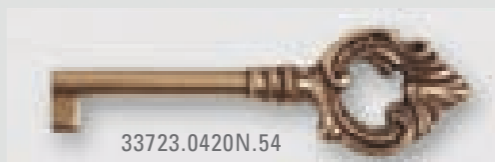

24452Z02500.54



33723.0420N.54



24452Z02000.54

CODICE <i>Code</i>	MISURE <i>Overall size</i>	INTERASSE <i>C. to C.</i>	CODICE <i>Code</i>	MISURE <i>Overall size</i>	INTERASSE <i>C. to C.</i>
09015.08300	83x69	-	30631.06200	62x29	-
09015.06200	62x52	-	30631.062V0	29x62	-
24452Z03500	35x28	Ø 35	33723.0420N	28x88	N 42 
24452Z03000	30x26	Ø 30	33723.0340N	28x80	N 34 
24452Z02500	25x23	Ø 25			
24452Z02000	20x21	Ø 20			

Barocco

Serie realizzabile in tutte le finiture indicate a catalogo / Series available in all finishes in the catalogue.

C.260

Stile

Finitura / Finish: 07 - Oro di Valenza

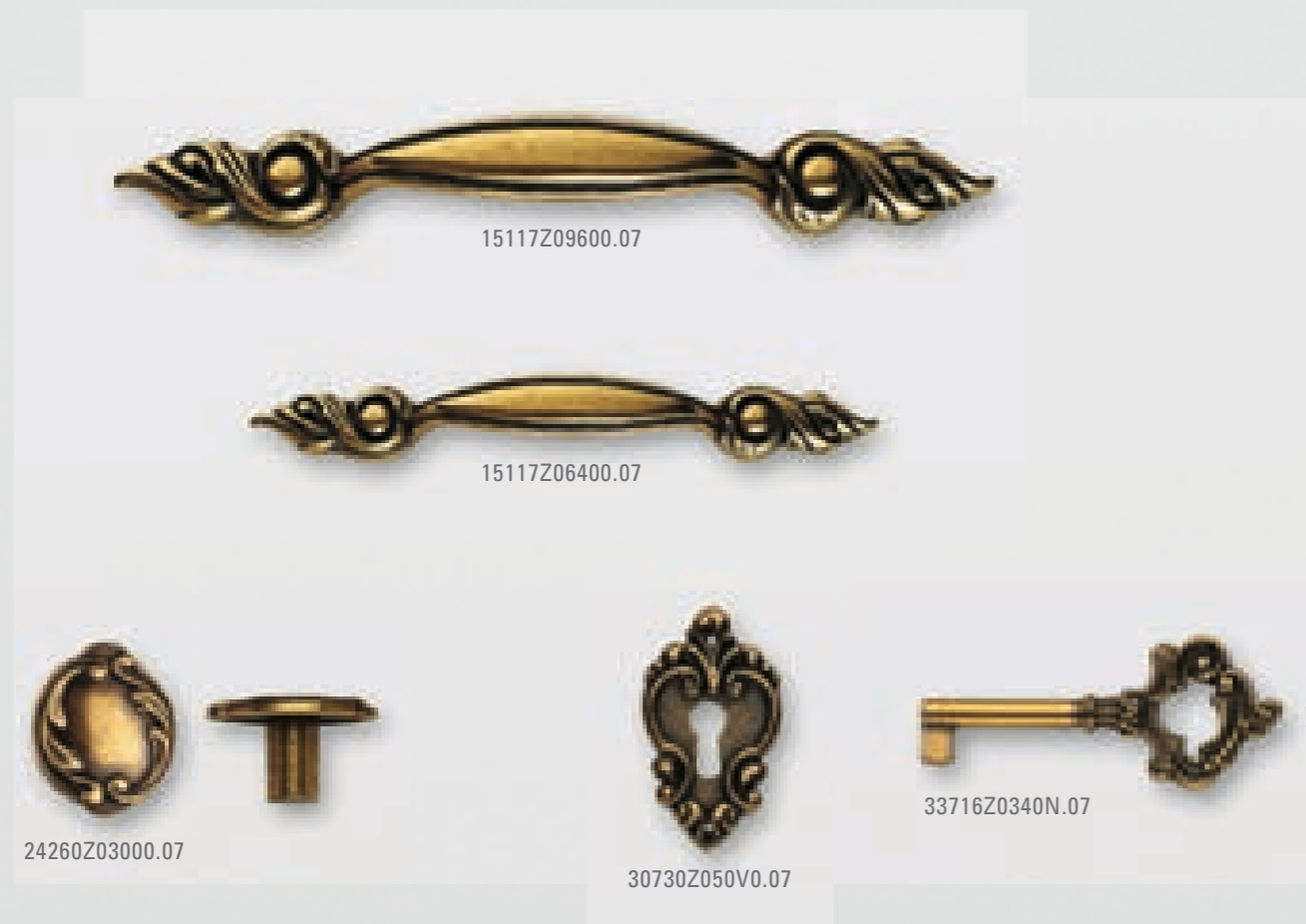

Barocco

Serie realizzabile in tutte le finiture indicate a catalogo / Series available in all finishes in the catalogue.

C.261

Stile

Finitura / Finish: 07 - Oro di Valenza

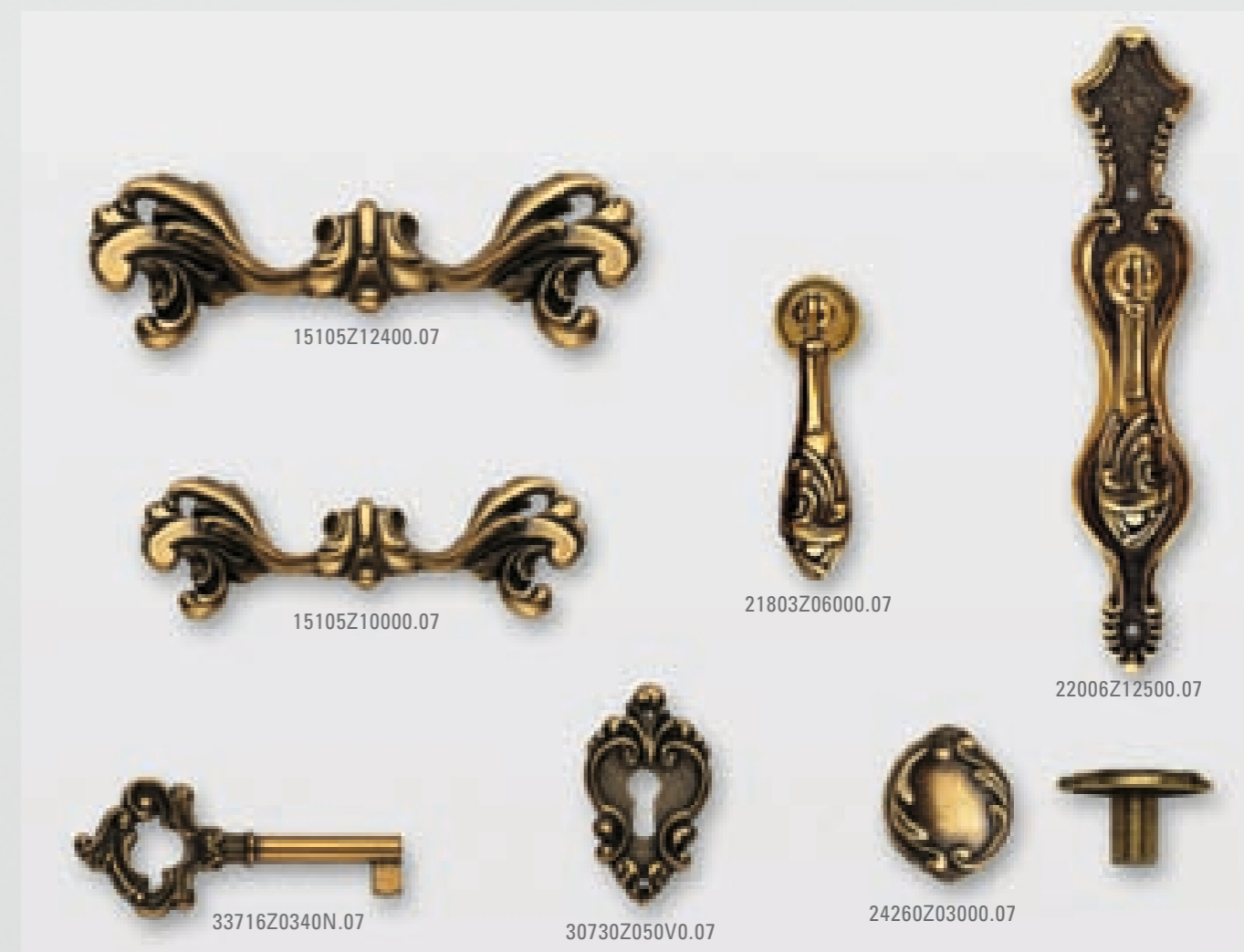

CODICE Code	MISURE Overall size	INTERASSE C.to C.
15117Z09600	162x20	96
15117Z06400	108x14	64
24260Z03000	31x25x18	-
30730Z050V0	29x51	-
33716Z0340N	32x73	N 34 

CODICE Code	MISURE Overall size	INTERASSE C.to C.
15105Z12400	124x40	64
15105Z10000	100x32	64
21803Z06000	20x70	-
22006Z12500	28x125	-

CODICE Code	MISURE Overall size	INTERASSE C.to C.
24260Z03000	31x25x18	-
30730Z050V0	29x50	-
33716Z0340N	32x73	N 34 

Chippendale

Serie realizzabile in tutte le finiture indicate a catalogo / Series available in all finishes in the catalogue.

Chippendale

Serie realizzabile in tutte le finiture indicate a catalogo / Series available in all finishes in the catalogue.

Finitura / Finish: 03 - Ottone antico / Antique brass

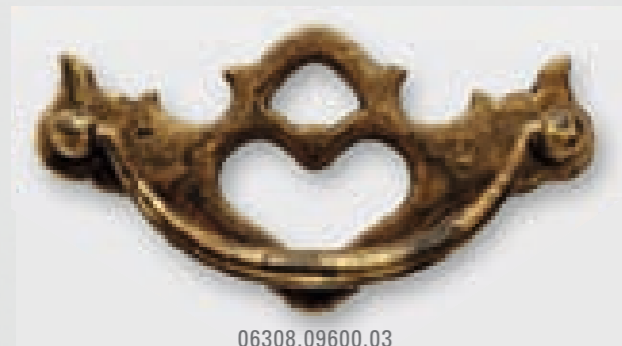

06308.09600.03

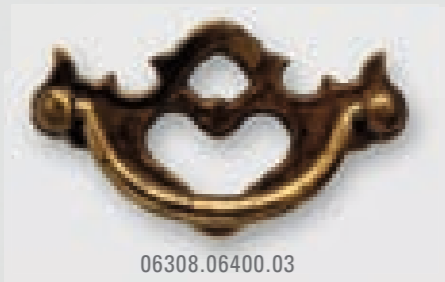

06308.06400.03



24492.04001.03



24492.03501.03



24492.03001.03



24492.02501.03



Finitura / Finish: 03 - Ottone antico / Antique brass

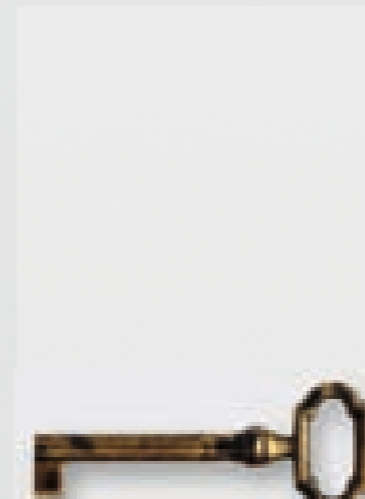

33727.0420N.03



21395Z04900.03



30617.180V0.03



30617.120V0.03



30617.069V0.03

CODICE Code	MISURE Overall size	INTERASSE C.to C.
06308.09600	114x59	96
06308.06400	77x45	64
24492.04001	40x30	Ø 40
24492.03501	35x28	Ø 35
24492.03001	30x24	Ø 30
24492.02501	25x21	Ø 25

CODICE Code	MISURE Overall size	INTERASSE C.to C.	CODICE Code	MISURE Overall size	INTERASSE C.to C.
21395Z04900	20x59	-	33727.0340N	27x61	N 34
30617.180V0	19x180	-	33727.0240N	27x51	N 24
30617.120V0	15x120	-			
30617.069V0	14x69	-			
33727.0420N	27x69	N 42			

Coloniale

Serie realizzabile in tutte le finiture indicate a catalogo / Series available in all finishes in the catalogue.

Finitura / Finish: 09 - Florence



15147Z12800.09



15147Z10000.09



15147Z09600.09



24147Z07300.09

CODICE <i>Code</i>	MISURE <i>Overall size</i>	INTERASSE <i>C. to C.</i>
15147Z12800	190x35	128
15147Z10000	102x34	64
15147Z09600	154x35	96
24147Z07300	73x31x23	32

Coloniale

Serie realizzabile in tutte le finiture indicate a catalogo / Series available in all finishes in the catalogue.

Finitura / Finish: 47 - Argento orientale / Oriental silver



30224Z094V0.47

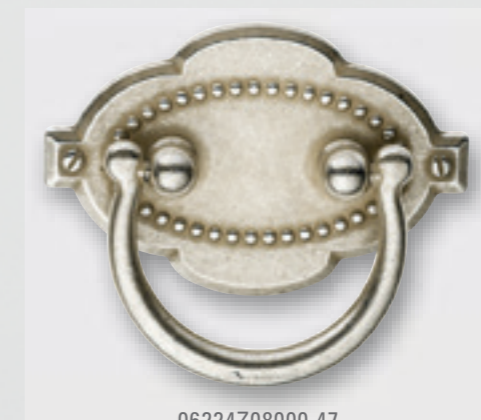

06224Z08000.47



30224Z06400.47



24222Z03000.47



24222Z02500.47

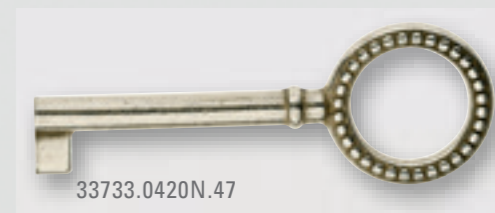

33733.0420N.47

CODICE <i>Code</i>	MISURE <i>Overall size</i>	INTERASSE <i>C. to C.</i>	CODICE <i>Code</i>	MISURE <i>Overall size</i>	INTERASSE <i>C. to C.</i>
06224Z08000	80x67	32	33733.0530N	28x88	N 53 
24222Z03000	30x22	Ø 30	33733.0420N	28x77	N 42 
24222Z02500	25x20	Ø 25	33733.0340N	28x69	N 34 
30224Z06400	64x42	-			
30224Z094V0	40x94	-			

Coloniale

Serie realizzabile in tutte le finiture indicate a catalogo / Series available in all finishes in the catalogue.

C.268

Stile

Finitura / Finish: 03 - Ottone antico / Antique brass
 19 - Similferro / Similiron
 22 - Old America
 91 - Pewter
 94 - Iron Effect



06320Z07500.03



06320Z07500.91



06320Z07500.19



06320Z07500.94



06320Z07500.22

Coloniale

Serie realizzabile in tutte le finiture indicate a catalogo / Series available in all finishes in the catalogue.

C.269

Stile

Finitura / Finish: 03 - Ottone antico / Antique brass
 19 - Similferro / Similiron
 22 - Old America



06014Z07500.03



06014Z07500.19



06014Z07500.22



24568Z02500.03



30568Z046V0.03



25568Z04600.03



27568Z04600.03

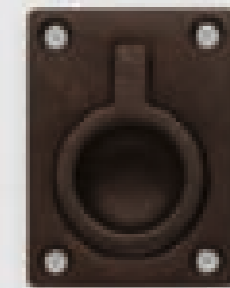

06327.05700.22

CODICE Code	MISURE Overall size	INTERASSE C.to C.
06320Z07500	75x50	-

CODICE Code	MISURE Overall size	INTERASSE C.to C.
06014Z07500	75x50	-
06327.05700	43x57	-
24568Z02500	25x25x28	-
25568Z04600	46x25	-
27568Z04600	46x21	-
30568Z046V0	21x46	-

Neoclassico

Serie realizzabile in tutte le finiture indicate a catalogo / Series available in all finishes in the catalogue.

Finitura / Finish: 07 - Oro di Valenza
09 - Florence

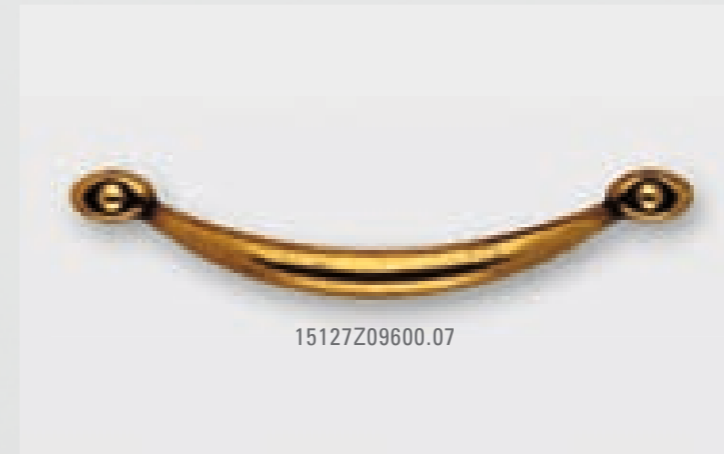

15127Z09600.07

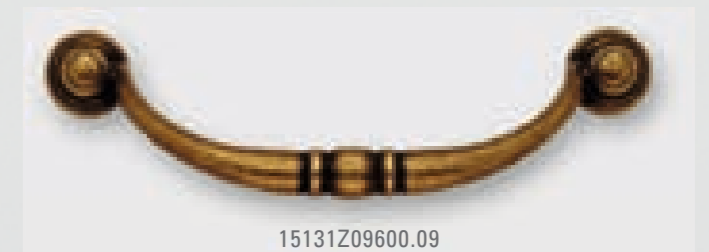

15131Z09600.09



15096Z06400.07

CODICE <i>Code</i>	MISURE <i>Overall size</i>	INTERASSE <i>C. to C.</i>
15127Z09600	111x22	96
15131Z09600	112x35	96
15096Z06400	84x36	64

Neoclassico

Serie realizzabile in tutte le finiture indicate a catalogo / Series available in all finishes in the catalogue.

Neoclassico

Serie realizzabile in tutte le finiture indicate a catalogo / Series available in all finishes in the catalogue.

Finitura / Finish: 07 - Oro di Valenza

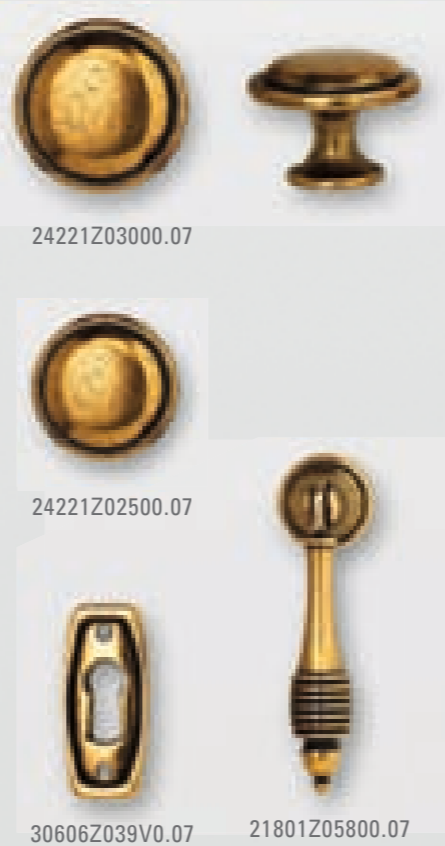

Finitura / Finish: 07 - Oro di Valenza



CODICE <i>Code</i>	MISURE <i>Overall size</i>	INTERASSE <i>C.to C.</i>
03049Z09600	123x51	96
03049Z06400	84x35	64
15115Z09600	120x52	96
15115Z06400	82x35	64
21801Z05800	20x68	-

CODICE <i>Code</i>	MISURE <i>Overall size</i>	INTERASSE <i>C.to C.</i>
24221Z03000	30x22	Ø 30
24221Z02500	25x20	Ø 25
30606Z039V0	18x40	-

CODICE <i>Code</i>	MISURE <i>Overall size</i>	INTERASSE <i>C.to C.</i>
22801Z13500	28x136	-
22801Z13501	28x136	-
22801Z11000	28x111	-
22801Z11001	28x111	-

Neoclassico

Serie realizzabile in tutte le finiture indicate a catalogo / Series available in all finishes in the catalogue.

Neoclassico

Serie realizzabile in tutte le finiture indicate a catalogo / Series available in all finishes in the catalogue.

Finitura / Finish: 07 - Oro di Valenza



Finitura / Finish: 07 - Oro di Valenza



CODICE Code	MISURE Overall size	INTERASSE C. to C.
03101Z09600	120x50	96
03101Z06400	85x35	64
21008Z04900	21x59	-
24221Z03000	30x22	Ø 30
24221Z02500	25x20	Ø 25
30606Z039V0	18x40	-

CODICE Code	MISURE Overall size	INTERASSE C. to C.
22008Z13500	28x136	-
22008Z13501	28x136	-
22008Z11000	28x111	-
22008Z11001	28x111	-

Neoclassico

Serie realizzabile in tutte le finiture indicate a catalogo / Series available in all finishes in the catalogue.

Neoclassico

Serie realizzabile in tutte le finiture indicate a catalogo / Series available in all finishes in the catalogue.

Finitura / Finish: 07 - Oro di Valenza

Finitura / Finish: 47 - Argento orientale / Oriental silver

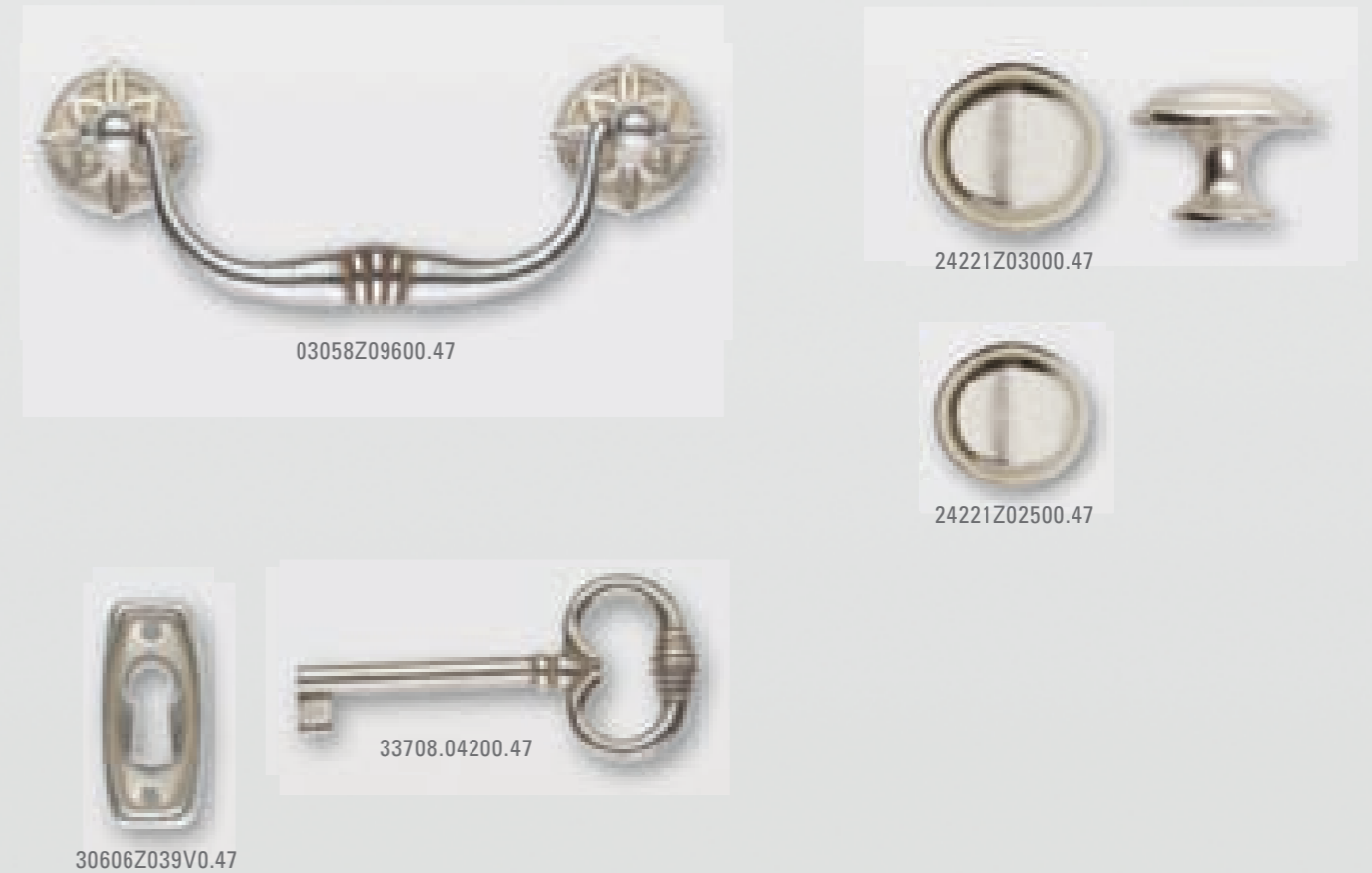

CODICE Code	MISURE Overall size	INTERASSE C. to C.	CODICE Code	MISURE Overall size	INTERASSE C. to C.	CODICE Code	MISURE Overall size	INTERASSE C. to C.	CODICE Code	MISURE Overall size	INTERASSE C. to C.
15029Z09600	135x49	96	30626.037V0	25x37	-	03058Z09600	126x48	96	33708.05300	35x81	N 53
15029Z06400	97x36	64	33731.0420N	35x69	N 42	24221Z03000	30x22	30	33708.04200	35x70	N 42
24224Z03000	30x22	30	33731.0340N	35x61	N 34	24221Z02500	25x20	25	33708.03400	35x62	N 34
24224Z02500	25x20	25				30606Z039V0	18x40	-			

Neoclassico

Serie realizzabile in tutte le finiture indicate a catalogo / Series available in all finishes in the catalogue.

C.278

Stile

Finitura / Finish: 03 - Ottone antico / Antique brass



15341.12800.03



15341.09600.03



15341.06400.03

Neoclassico

Serie realizzabile in tutte le finiture indicate a catalogo / Series available in all finishes in the catalogue.

C.279

Stile

Finitura / Finish: 03 - Ottone antico / Antique brass



15342.06400.03

15342.06401.03

15342.09600.03

15342.09601.03

CODICE <i>Code</i>	MISURE <i>Overall size</i>	INTERASSE <i>C.to C.</i>
15341.12800	162x21	128
15341.09600	130x20	96
15341.06400	98x20	64

CODICE <i>Code</i>	MISURE <i>Overall size</i>	INTERASSE <i>C.to C.</i>
15342.09600	20x158	96
15342.09601	20x158	96
15342.06400	16x122	64
15342.06401	16x122	64

Finitura / Finish: D0 - Watery Rust



Finitura / Finish: 12 - Ottone satinato / Satin brass



C.281

Stile



Neoclassico

Serie realizzabile in tutte le finiture indicate a catalogo / Series available in all finishes in the catalogue.

Neoclassico

Serie realizzabile in tutte le finiture indicate a catalogo / Series available in all finishes in the catalogue.

Finitura / Finish: 09 - Firenze

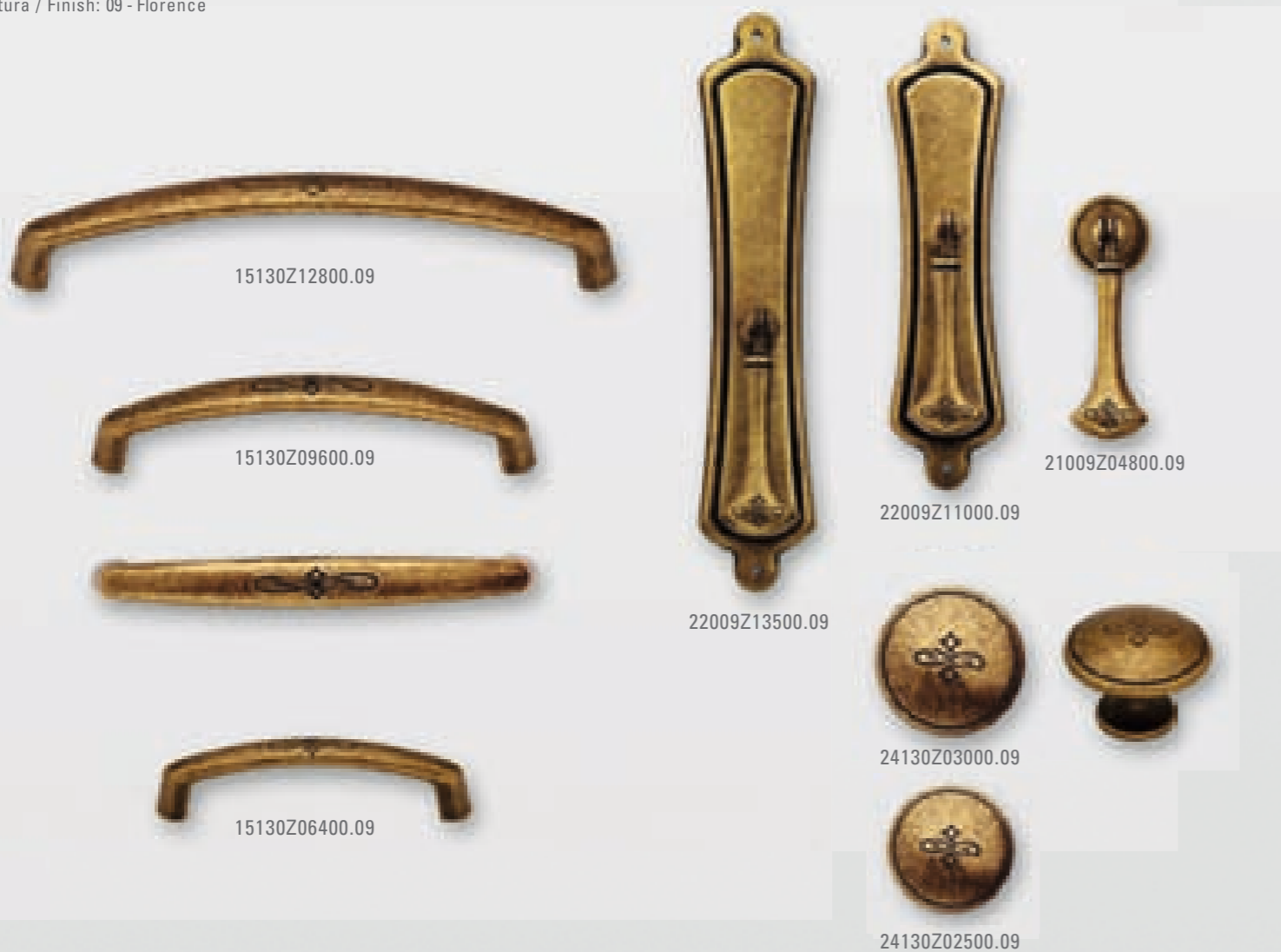

Finitura / Finish: 19 - Similferro / Similiron



CODICE <i>Code</i>	MISURE <i>Overall size</i>	INTERASSE <i>C.to C.</i>
15130Z12800	138x14	128
15130Z09600	105x12	96
15130Z06400	73x9	64
21009Z04800	20x58	-
22009Z13500	28x136	-

CODICE <i>Code</i>	MISURE <i>Overall size</i>	INTERASSE <i>C.to C.</i>
22009Z11000	28x111	-
24130Z03000	30x22	Ø 30
24130Z02500	25x20	Ø 25

CODICE <i>Code</i>	MISURE <i>Overall size</i>	INTERASSE <i>C.to C.</i>
15230Z09600	105x12	96
18230Z09600	123x24	96



Neoclassico

Serie realizzabile in tutte le finiture indicate a catalogo / Series available in all finishes in the catalogue.

Finitura / Finish: 03 - Ottone antico / Antique brass



15062.12800.03

15062.09600.03

15062.06400.03

24216Z03000.03

CODICE <i>Code</i>	MISURE <i>Overall size</i>	INTERASSE <i>C. to C.</i>
15062.12800	143x13	128
15062.09600	109x13	96
15062.06400	76x11	64
24216Z03000	29x20x20	-

Country

Serie realizzabile in tutte le finiture indicate a catalogo / Series available in all finishes in the catalogue.

Finitura / Finish: 07 - Oro di Valenza



15052.09600.07



15052.06400.07

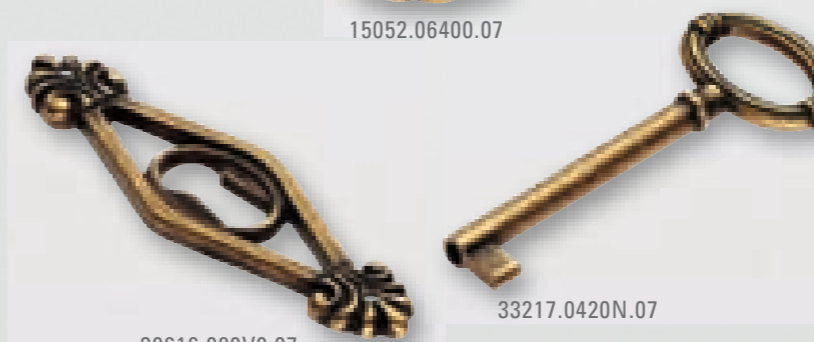

30616.080V0.07



33217.0420N.07





24477Z03000.07



24477Z02500.07



24477Z02000.07

CODICE <i>Code</i>	MISURE <i>Overall size</i>	INTERASSE <i>C.to C.</i>	CODICE <i>Code</i>	MISURE <i>Overall size</i>	INTERASSE <i>C.to C.</i>
15052.09600	136x27	96	33217.0530N	32x80	N 53 
15052.06400	103x24	64	33217.0420N	32x69	N 42 
24477Z03000	30x23	Ø 30	33217.0340N	32x61	N 34 
24477Z02500	25x20	Ø 25			
24477Z02000	20x18	Ø 20			
30616.080V0	23x80	-			

Decorativo

Serie realizzabile in tutte le finiture indicate a catalogo / Series available in all finishes in the catalogue.

C.288

Stile

Finitura / Finish: 07 - Oro di Valenza

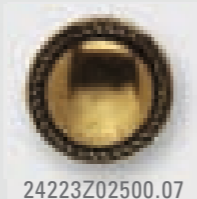

Decorativo

Serie realizzabile in tutte le finiture indicate a catalogo / Series available in all finishes in the catalogue.

C.289

Stile

Finitura / Finish: 07 - Oro di Valenza

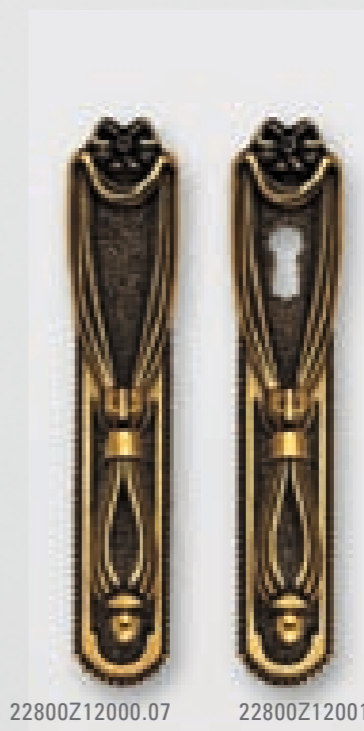
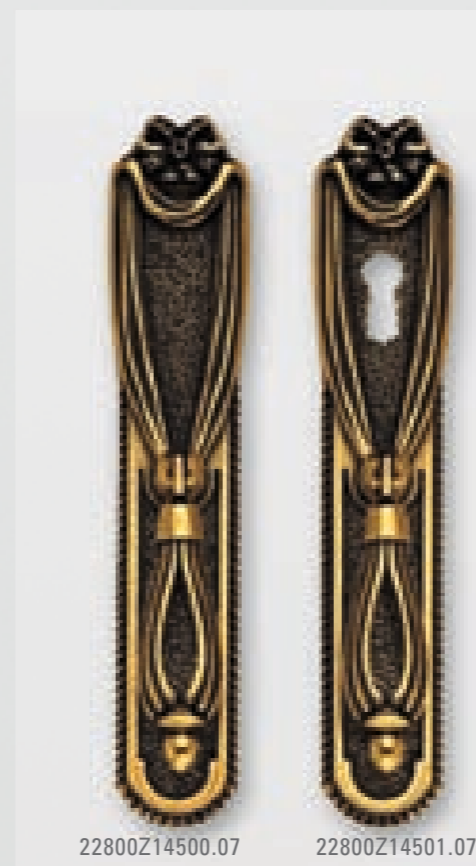

CODICE Code	MISURE Overall size	INTERASSE C.to C.
03002Z09600	120x50	96
03002Z06400	84x35	64
21800Z06100	20x70	-
24223Z03000	30x22	Ø 30

CODICE Code	MISURE Overall size	INTERASSE C.to C.
24223Z02500	25x20	Ø 25
30600Z040V0	27x40x15	Ø 19
30600Z040V1	27x40x15	Ø 19

CODICE Code	MISURE Overall size	INTERASSE C.to C.
22800Z14500	29x145	-
22800Z14501	29x145	-
22800Z12000	25x124	-
22800Z12001	25x124	-

Decorativo

Serie realizzabile in tutte le finiture indicate a catalogo / Series available in all finishes in the catalogue.

Decorativo

Serie realizzabile in tutte le finiture indicate a catalogo / Series available in all finishes in the catalogue.

Finitura / Finish: 54 - Patinè BM



06286Z06400.54

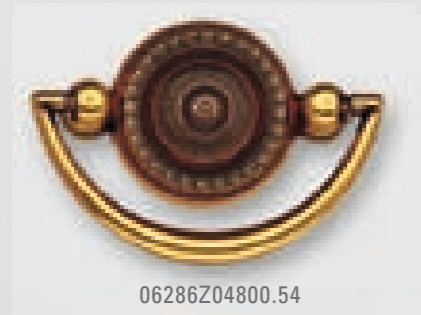

06286Z04800.54



24286Z03000.54



24286Z02500.54

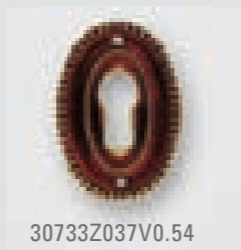

30733Z037V0.54

Finitura / Finish: 54 - Patinè BM

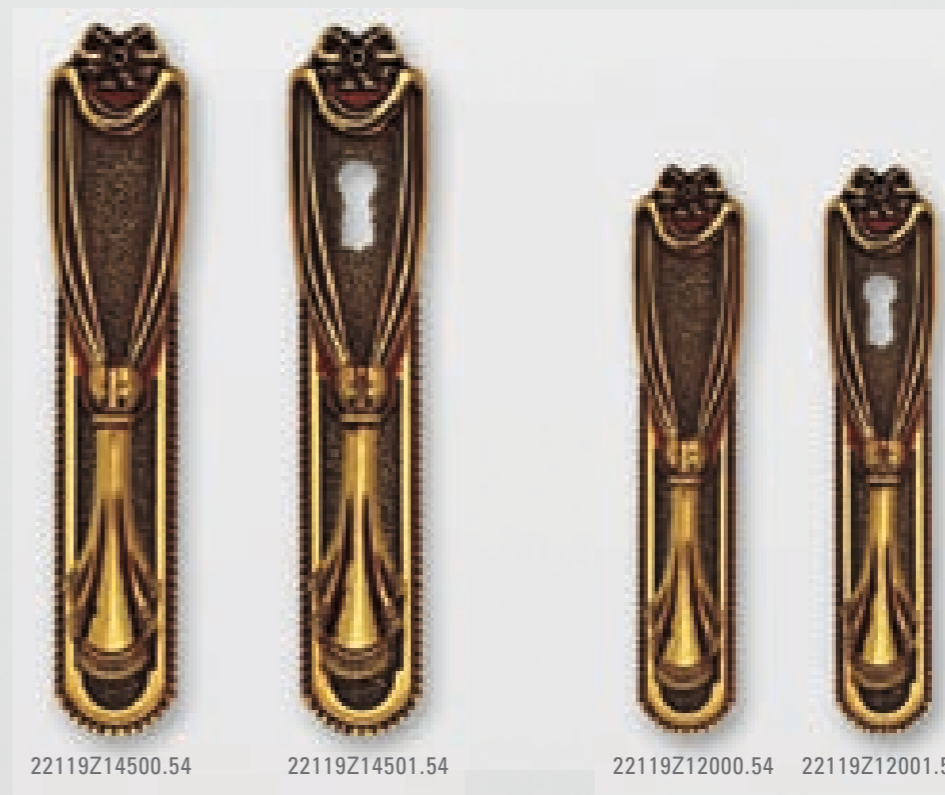

22119Z14500.54

22119Z14501.54

22119Z12000.54

22119Z12001.54

CODICE Code	MISURE Overall size	INTERASSE C.to C.
06286Z06400	97x70	64
06286Z04800	72x53	48
24286Z03000	30x21	30 Ø
24286Z02500	25x19	25 Ø
30733Z037V0	25x37	-

CODICE Code	MISURE Overall size	INTERASSE C.to C.
22119Z14500	29x145	-
22119Z14501	29x145	-
22119Z12000	25x120	-
22119Z12001	25x120	-

Decorativo

Serie realizzabile in tutte le finiture indicate a catalogo / Series available in all finishes in the catalogue.

Directoire

Serie realizzabile in tutte le finiture indicate a catalogo / Series available in all finishes in the catalogue.

Finitura / Finish: 07 - Oro di Valenza

Finitura / Finish: 07 - Oro di Valenza

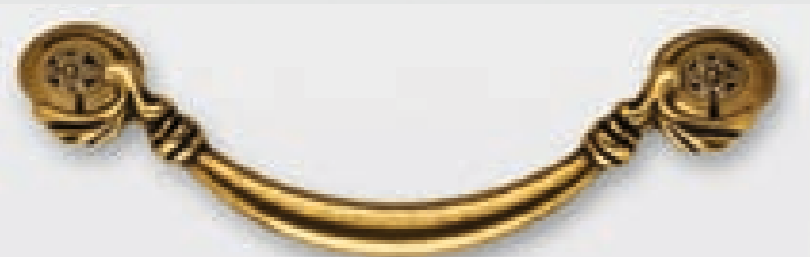

03030Z12800.07



03030Z09600.07



03030Z06400.07

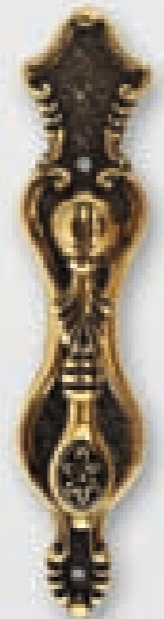

22007Z12500.07



24802Z03000.07



24802Z02500.07



21802Z06000.07



06285.07500.07

CODICE Code	MISURE Overall size	INTERASSE C.to C.
03030Z12800	155x47	128
03030Z09600	123x46	96
03030Z06400	90x36	64
21802Z06000	20x74	-

CODICE Code	MISURE Overall size	INTERASSE C.to C.
22007Z12500	28x125	-
24802Z03000	30x22	30
24802Z02500	25x20	25

CODICE Code	MISURE Overall size	INTERASSE C.to C.
06285.07500	103x79	75

Directoire

Serie realizzabile in tutte le finiture indicate a catalogo / Series available in all finishes in the catalogue.

C.294

Stile

Finitura / Finish: 09 - Firenze

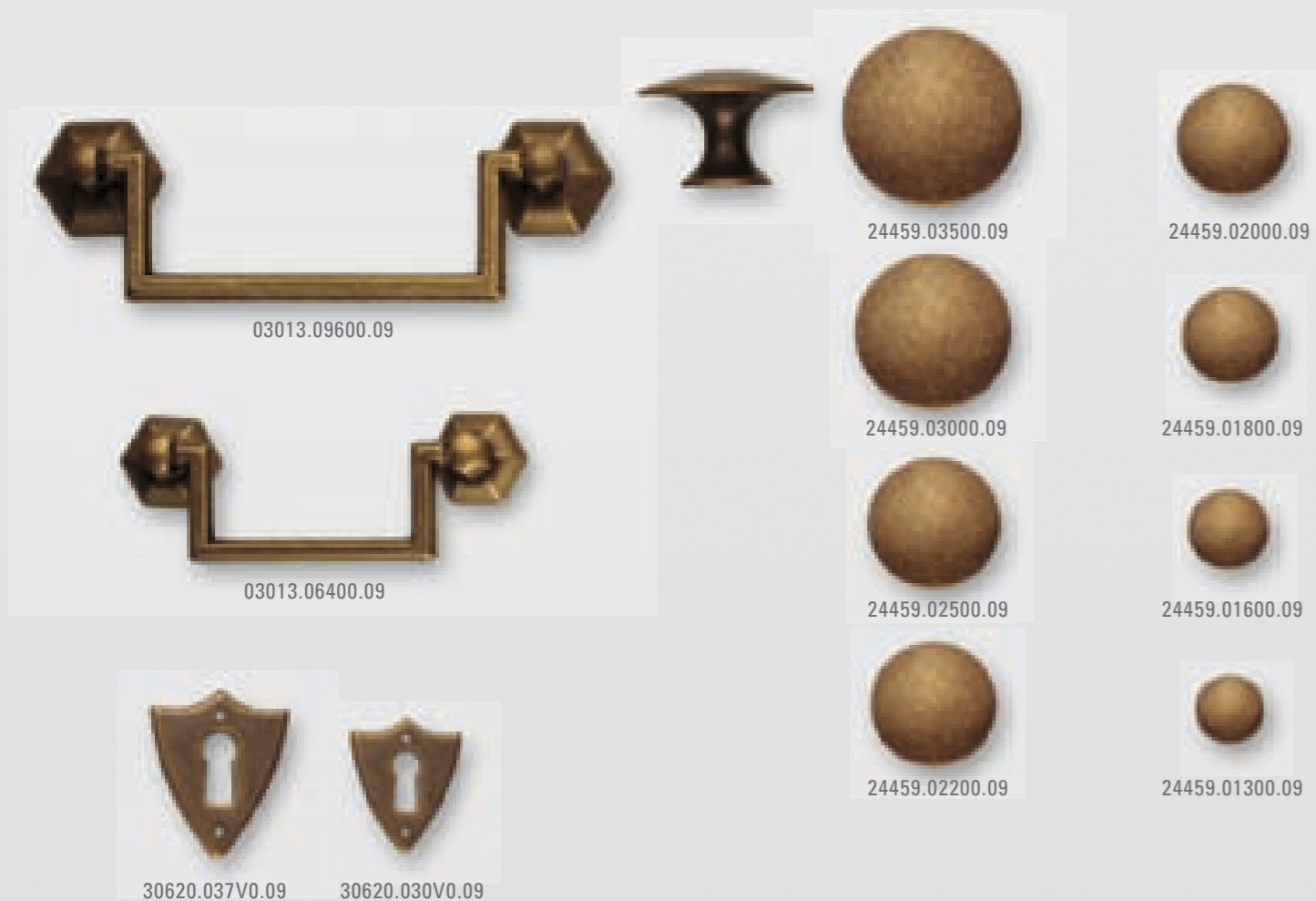

Directoire

Serie realizzabile in tutte le finiture indicate a catalogo / Series available in all finishes in the catalogue.

C.295

Stile

Finitura / Finish: 03 - Ottone antico / Antique brass

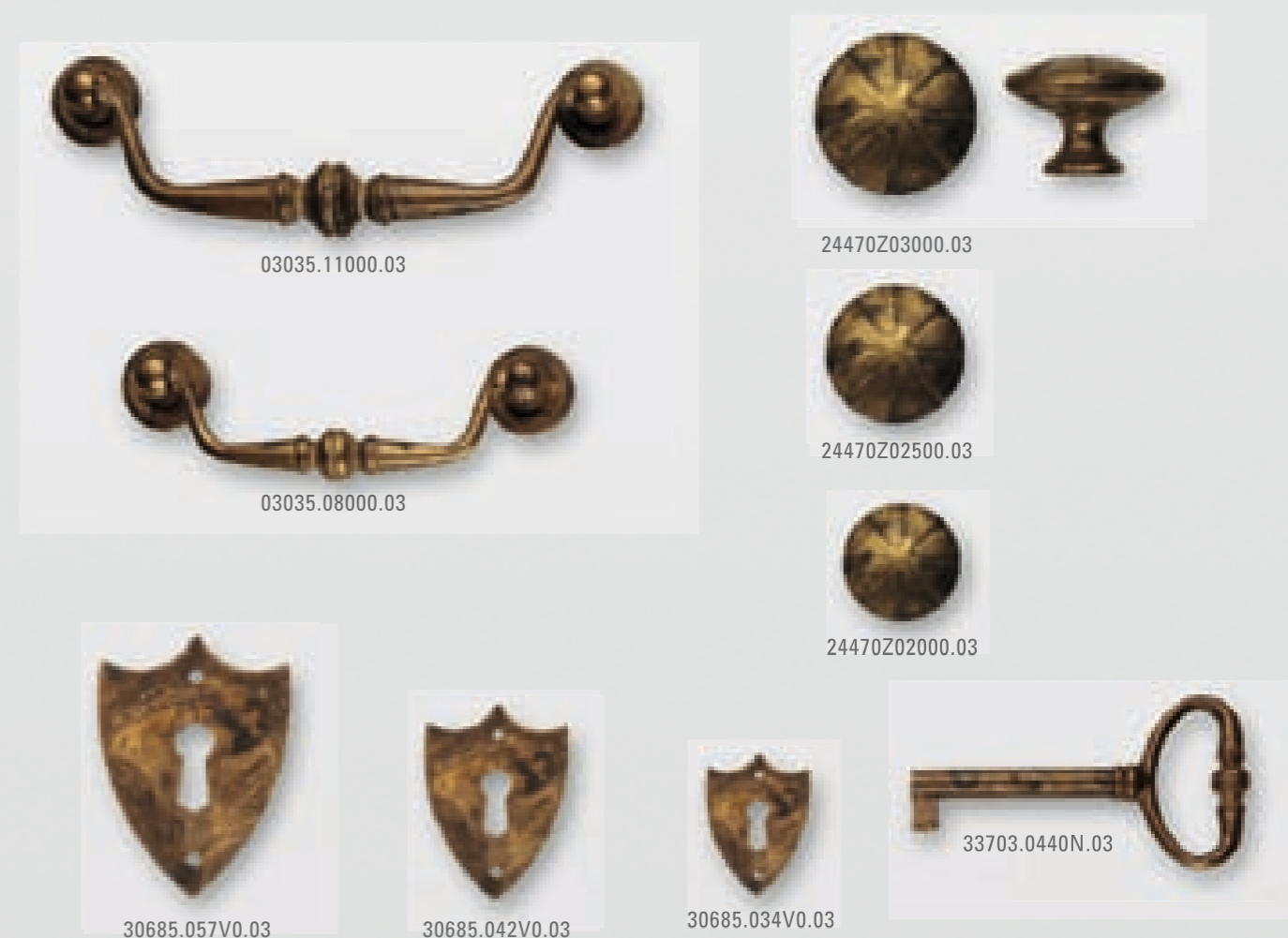

CODICE Code	MISURE Overall size	INTERASSE C.to C.	CODICE Code	MISURE Overall size	INTERASSE C.to C.	CODICE Code	MISURE Overall size	INTERASSE C.to C.	CODICE Code	MISURE Overall size	INTERASSE C.to C.
03013.09600	128x48	96	24459.02000	20x15	Ø 20	03035.11000	129x43	110	30685.042V0	30x42	-
03013.06400	78x36	64	24459.01800	18x14	Ø 18	03035.08000	98x34	80	30685.057V0	42x57	-
24459.03500	35x22	Ø 35	24459.01600	16x12	Ø 16	24470Z03000	30x23	Ø 30	33703.0530N	30x93	N 53
24459.03000	30x20	Ø 30	24459.01300	13x10	Ø 13	24470Z02500	25x20	Ø 25	33703.0440N	30x84	N 44
24459.02500	25x19	Ø 25	30620.037V0	30x37	-	24470Z02000	20x18	Ø 20	33703.0340N	30x74	N 34
24459.02200	22x15	Ø 22	30620.030V0	25x30	-	30685.034V0	24x34	-			

Arts & Crafts

Serie realizzabile in tutte le finiture indicate a catalogo / Series available in all finishes in the catalogue.

Arts & Crafts

Serie realizzabile in tutte le finiture indicate a catalogo / Series available in all finishes in the catalogue.

Finitura / Finish: 22 - Old America

Finitura / Finish: 22 - Old America



25145Z09500.22



12145Z09500.22



06145Z13000.22

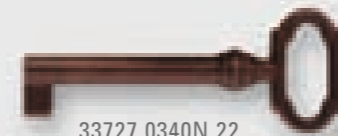

33727.0340N.22



03145Z06400.22



12145Z03900.22



09145Z02800.22



30145Z048V0.22



45145Z16800.22

CODICE Code	MISURE Overall size	INTERASSE C.to C.
03145Z06400	91x41	64
06145Z13000	130x44	64
09145Z02800	28x41	-
12145Z03900	29x38	-
12145Z09500	29x95	-
25145Z09500	29x95	-

CODICE Code	MISURE Overall size	INTERASSE C.to C.
30145Z048V0	27x48	-
33727.0240N	27x51	24N
33727.0340N	27x61	34N
33727.0420N	27x69	42N

CODICE Code	MISURE Overall size	INTERASSE C.to C.
45145Z16800	168x168x21	-

Arts & Crafts

Serie realizzabile in tutte le finiture indicate a catalogo / Series available in all finishes in the catalogue.

Arts & Crafts

Serie realizzabile in tutte le finiture indicate a catalogo / Series available in all finishes in the catalogue.

Finitura / Finish: 25 - Argento Vecchio / Old silver

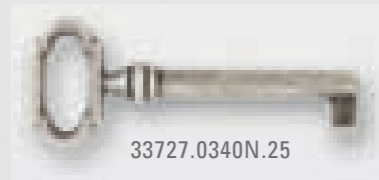

33727.0340N.25



30145Z048V0.25

06446Z06400.25

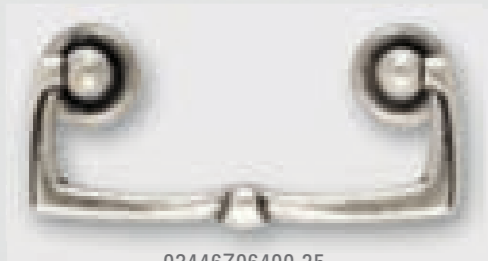

03446Z06400.25



24446Z03000.25

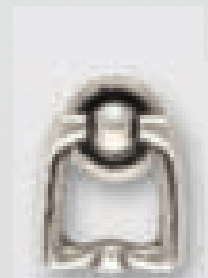

09446Z02900.25



12446Z05500.25



12446Z10000.25



25446Z10000.25



25446Z05000.25

Finitura / Finish: 25 - Argento Vecchio / Old silver



45446Z16800.25

CODICE Code	MISURE Overall size	INTERASSE C.to C.
03446Z06400	90x44	64
06446Z06400	94x55	64
09446Z02900	29x41	-
12446Z05500	30x55	-
12446Z10000	30x100	-
25446Z10000	30x100	-

CODICE Code	MISURE Overall size	INTERASSE C.to C.
25446Z05000	30x50	-
24446Z03000	30x22	Ø 30
33727.0240N	27x51	24N
33727.0340N	27x61	34N
33727.0420N	27x69	42N

CODICE Code	MISURE Overall size	INTERASSE C.to C.
45446Z16800	168x168x17	-

Grunderzeit

Serie realizzabile in tutte le finiture indicate a catalogo / Series available in all finishes in the catalogue.

Grunderzeit

Serie realizzabile in tutte le finiture indicate a catalogo / Series available in all finishes in the catalogue.

Finitura / Finish: 32 - Nickel lucido / Bright nickel



06305.06400.32



06305.06401.32



30692.11400.32

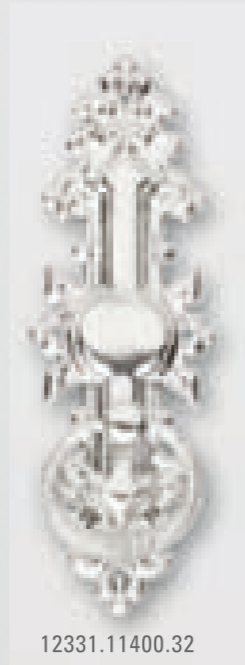

12331.11400.32

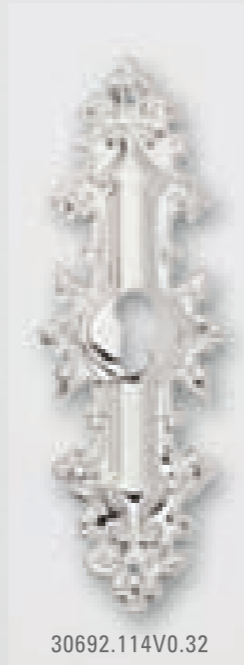

30692.114V0.32

Finitura / Finish: 03 - Ottone Antico / Antique brass

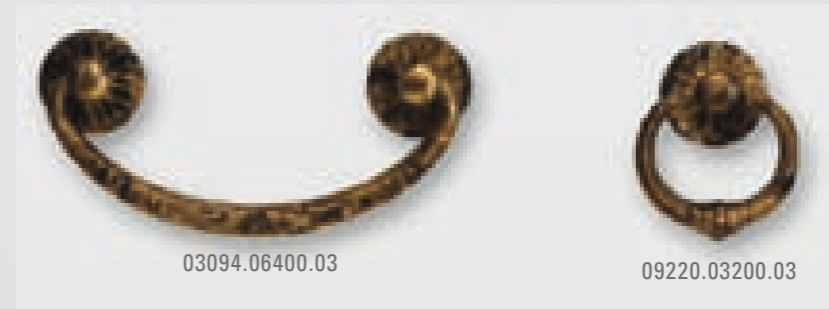

03094.06400.03

09220.03200.03

CODICE Code	MISURE Overall size	INTERASSE C. to C.
06305.06400	114x50	64
06305.06401	114x50	64
30692.11400	114x38	-
12331.11400	38x114	-
30692.114V0	38x114	-

CODICE Code	MISURE Overall size	INTERASSE C. to C.
03094.06400	89x42	64
09220.03200	32x41	-

Hepplewhite

Serie realizzabile in tutte le finiture indicate a catalogo / Series available in all finishes in the catalogue.

Hepplewhite

Serie realizzabile in tutte le finiture indicate a catalogo / Series available in all finishes in the catalogue.

Finitura / Finish: 03 - Ottone antico / Antique brass



Finitura / Finish: 03 - Ottone antico / Antique brass



CODICE <i>Code</i>	MISURE <i>Overall size</i>	INTERASSE <i>C. to C.</i>
06216.06400	82x60	64
06216.05200	70x49	52
30704.06400	64x49	-

CODICE <i>Code</i>	MISURE <i>Overall size</i>	INTERASSE <i>C. to C.</i>
06217.06400	82x60	64
06217.05200	70x49	52
30706.06400	64x49	-

Hepplewhite

Serie realizzabile in tutte le finiture indicate a catalogo / Series available in all finishes in the catalogue.

Hepplewhite

Serie realizzabile in tutte le finiture indicate a catalogo / Series available in all finishes in the catalogue.

Finitura / Finish: 03 - Ottone antico / Antique brass



06218.06400.03

06218.05200.03

30707.06400.03

Finitura / Finish: 03 - Ottone antico / Antique brass



06219.06400.03

06219.05200.03

30708.06400.03

CODICE <i>Code</i>	MISURE <i>Overall size</i>	INTERASSE <i>C. to C.</i>
06218.06400	82x60	64
06218.05200	70x49	52
30707.06400	64x49	-

CODICE <i>Code</i>	MISURE <i>Overall size</i>	INTERASSE <i>C. to C.</i>
06219.06400	82x60	64
06219.05200	70x49	52
30708.06400	64x49	-

Hepplewhite

Serie realizzabile in tutte le finiture indicate a catalogo / Series available in all finishes in the catalogue.

Hepplewhite

Serie realizzabile in tutte le finiture indicate a catalogo / Series available in all finishes in the catalogue.

Finitura / Finish: 54 - Patinè bm



06220.06400.54

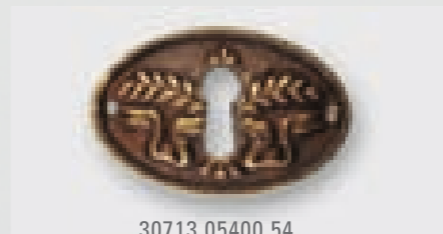

30713.05400.54



06220.05200.54

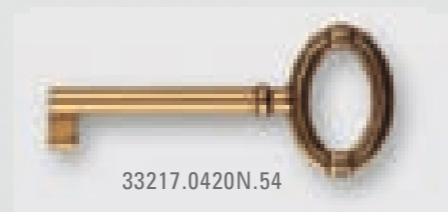

33217.0420N.54

Finitura / Finish: 54 - Patinè bm

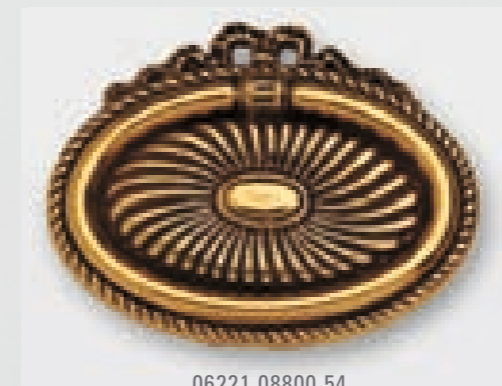

06221.08800.54

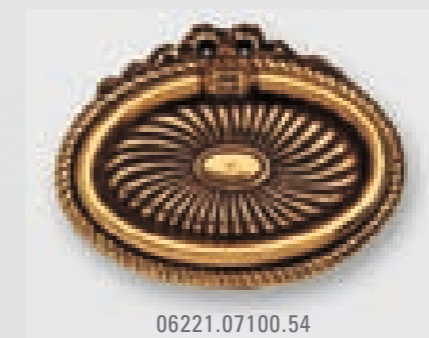

06221.07100.54



06221.05300.54

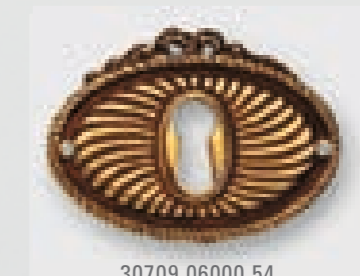

30709.06000.54

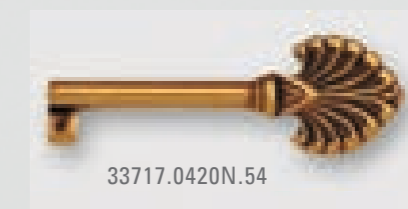

33717.0420N.54

CODICE Code	MISURE Overall size	INTERASSE C. to C.
06220.06400	82x62	64
06220.05200	70x51	52
30713.05400	54x35	-
33217.0530N	32x80	N 53
33217.0420N	32x69	N 42
33217.0340N	32x61	N 34

CODICE Code	MISURE Overall size	INTERASSE C. to C.
06221.08800	88x68	32
06221.07100	71x54	32
06221.05300	53x40	-
30709.06000	60x44	-
33717.0420N	25x72	N 42

Impero

Serie realizzabile in tutte le finiture indicate a catalogo / Series available in all finishes in the catalogue.

C.308

Stile

Finitura / Finish: 54 - Patinè bm

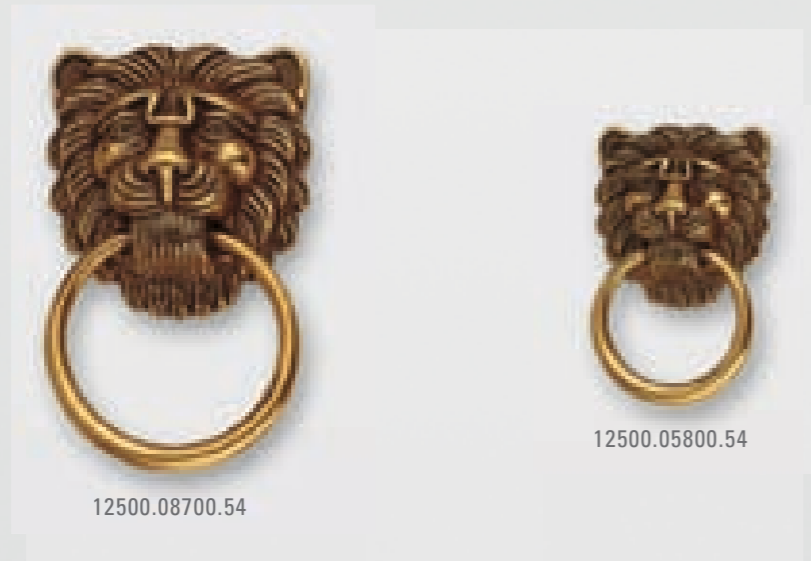

12500.08700.54

12500.05800.54

Impero

Serie realizzabile in tutte le finiture indicate a catalogo / Series available in all finishes in the catalogue.

C.309

Stile

Finitura / Finish: 54 - Patinè bm



03325.09500.54



03325.07500.54



33717.0420N.54



30616.08000.54



30616.080V0.54



24405.03500.54



24405.03000.54



24405.02500.54



24405.02000.54



CODICE Code	MISURE Overall size	INTERASSE C.to C.
12500.08700	87x50	-
12500.05800	58x33	-

CODICE Code	MISURE Overall size	INTERASSE C.to C.
03325.09500	95x63	32
03325.07500	75x55	32
24405.03500	35x25	Ø 35
24405.03000	30x20	Ø 30
24405.02500	25x17	Ø 25
24405.02000	20x16	Ø 20

CODICE Code	MISURE Overall size	INTERASSE C.to C.
30616.080V0	23x80	-
30616.08000	80x23	-
33717.0420N	25x72	N 42

Impero

Serie realizzabile in tutte le finiture indicate a catalogo / Series available in all finishes in the catalogue.

Jugendstil

Serie realizzabile in tutte le finiture indicate a catalogo / Series available in all finishes in the catalogue.

Finitura / Finish: 54 - Patinè bm

Finitura / Finish: 03 - Ottone antico / Antique brass



18327.06400.54



18327.03200.54



30632.03900.54

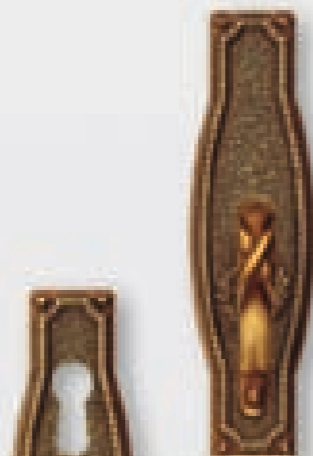

18326.03200.54



18326.03201.54



33726.0420N.54



24405.03500.54



24405.03000.54



24405.02500.54



24405.02000.54



06328.06400.03



03088.06400.03



30687.09700.03

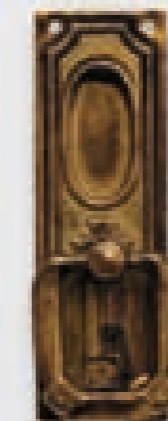

12328.08500.03



30687.085V0.03



09233.03200.03

CODICE
Code

MISURE
Overall size

INTERASSE
C.to C.

CODICE
Code

MISURE
Overall size

INTERASSE
C.to C.

CODICE
Code

MISURE
Overall size

INTERASSE
C.to C.





18326.03200
18326.03201
18327.06400
18327.03200
24405.03500
24405.03000
24405.02500

26x91
26x91
98x43
63x33
35x25
30x20
25x17

32
32
64
32
Ø 35
Ø 30
Ø 25

24405.02000
30632.03900
33726.0530N
33726.0420N
33726.0340N
33726.0240N

20x16
39x39
24x87
24x76
24x68
24x58

Ø 20
-
N 53 
N 42 
N 34 
N 24 

03088.06400
06328.06400
09233.03200
12328.08500
30687.09700
30687.085V0

89x42
97x42
32x41
32x85
97x34
28x85

64
64
-
-
-
-

Fugendstil

Serie realizzabile in tutte le finiture indicate a catalogo / Series available in all finishes in the catalogue.

Fugendstil

Serie realizzabile in tutte le finiture indicate a catalogo / Series available in all finishes in the catalogue.

Finitura / Finish: 03 - Ottone antico / Antique brass

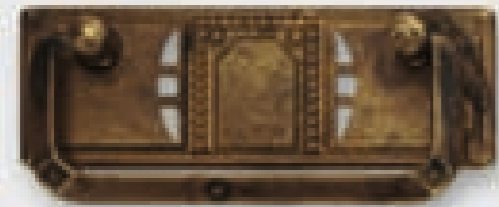

06324.06400.03



09233.03200.03



12327.05000.03



06324.06401.03



03088.06400.03

Finitura / Finish: 03 - Ottone antico / Antique brass



30684.085V0.03



30684.09700.03



30684.03500.03



12324.08500.03



12324.08501.03

CODICE Code	MISURE Overall size	INTERASSE C. to C.
03088.06400	89x42	64
06324.06400	97x42	64
06324.06401	97x42	64
09233.03200	32x41	-
12327.05000	35x50	-

CODICE Code	MISURE Overall size	INTERASSE C. to C.
12324.08500	32x85	-
12324.08501	32x85	-
12327.05000	35x50	-
30684.03500	35x35	-
30684.085V0	27x85	-
30684.09700	97x33	-

Liberty

Serie realizzabile in tutte le finiture indicate a catalogo / Series available in all finishes in the catalogue.

Finitura / Finish: 03 - Ottone antico / Antique brass



18062.09600.03



24850Z03000.03



18062.06400.03



24850Z02500.03



33850.0420N.03



30162.06400.03



30162.064V0.03

CODICE CODE	MISURE OVERALL SIZE	INTERASSE C.to C.	CODICE CODE	MISURE OVERALL SIZE	INTERASSE C.to C.
18062.09600	113x40	96	33850.0420N	31x76	42 
18062.06400	80x31	64	33850.0340N	31x68	34 
24850Z03000	30x26	Ø 30			
24850Z02500	25x23	Ø 25			
30162.064V0	33x64	-			
30162.06400	64x33	-			

Liberty

Serie realizzabile in tutte le finiture indicate a catalogo / Series available in all finishes in the catalogue.

Finitura/Finish: 03 - Ottone antico / Antique brass



15111.09600.03



15111.06400.03



30654.09000.03



15113.06400.03



15113.06401.03

CODICE <i>Code</i>	MISURE <i>Overall size</i>	INTERASSE <i>C.to C.</i>
15111.09600	120x42	96
15111.06400	91x33	64
15113.06400	17x139	64
15113.06401	17x139	64
30654.09000	90x35	-

Liberty

Serie realizzabile in tutte le finiture indicate a catalogo / Series available in all finishes in the catalogue.

C.318

Stile

Finitura / Finish: 03 - Ottone antico / Antique brass



Liberty

Serie realizzabile in tutte le finiture indicate a catalogo / Series available in all finishes in the catalogue.

C.319

Stile

Finitura / Finish: 09 - Firenze
25 - Argento vecchio / Old silver



CODICE <i>Code</i>	MISURE <i>Overall size</i>	INTERASSE <i>C.to C.</i>
15108.11500	23x115	49
15108.11501	23x115	49
15112.06400	127x48	64
15112.04800	97x35	48
30690.09200	92x32	-

CODICE <i>Code</i>	MISURE <i>Overall size</i>	INTERASSE <i>C.to C.</i>
15101.06400	80x46	64
24224Z03000	30x22	Ø 30
24224Z02500	25x20	Ø 25

Liberty

Serie realizzabile in tutte le finiture indicate a catalogo / Series available in all finishes in the catalogue.

Liberty

Serie realizzabile in tutte le finiture indicate a catalogo / Series available in all finishes in the catalogue.

Finitura/Finish: 03 - Ottone antico / Antique brass

Ottone/Brass



06322.06400.03



06322.06401.03

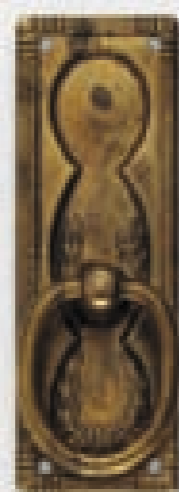

12231.09700.03

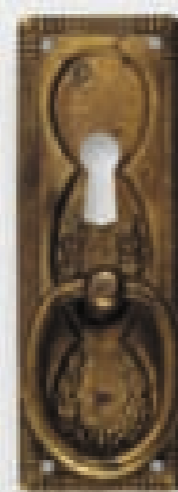

12231.09701.03



12223.05500.03



30676.09700.03



30676.097V0.03

Finitura/Finish: 09 - Florence

Zama/Zamak



06323Z10900.09



06323Z06400.09



06323Z06401.09



30705Z097V0.09

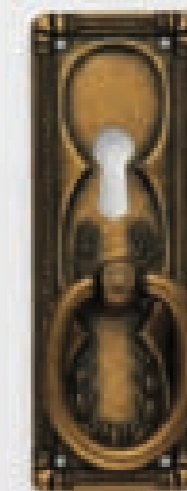

12233Z09701.09

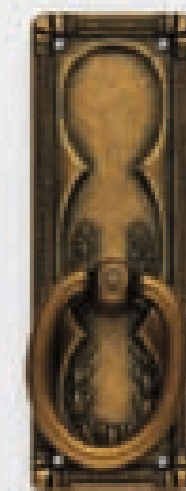

12233Z09700.09

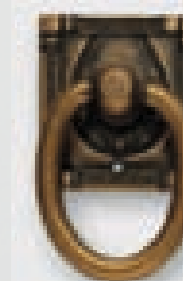

12323Z03500.09



30705Z10900.09



30650Z043V0.09



30705Z09700.09



30650Z04300.09

CODICE Code	MISURE Overall size	INTERASSE C.to C.
06322.06400	97x44	64
06322.06401	97x44	64
12223.05500	34x55	-
12231.09700	34x97	-
12231.09701	34x97	-

CODICE Code	MISURE Overall size	INTERASSE C.to C.
30676.097V0	33x97	-
30676.09700	97x33	-

CODICE Code	MISURE Overall size	INTERASSE C.to C.
06323Z10900	109x46	64
06323Z06401	97x45	64
06323Z06400	97x45	64
12233Z09700	33x97	-
12233Z09701	33x97	-
12323Z03500	33x57	-

CODICE Code	MISURE Overall size	INTERASSE C.to C.
30650Z043V0	25x43	-
30650Z04300	43x25	-
30705Z10900	109x39	-
30705Z097V0	33x97	-
30705Z09700	97x33	-

Liberty

Serie realizzabile in tutte le finiture indicate a catalogo / Series available in all finishes in the catalogue.

Liberty

Serie realizzabile in tutte le finiture indicate a catalogo / Series available in all finishes in the catalogue.

Finitura / Finish: 09 - Firenze



Finitura / Finish: 03 - Ottone antico / Antique brass



CODICE Code	MISURE Overall size	INTERASSE C.to C.
06060Z11200	112x48	64
06060Z09700	97x45	64
12060Z09700	33x97	-
12060Z09701	33x97	-
12060Z05400	33x55	-
30060Z11200	112x38	-

CODICE Code	MISURE Overall size	INTERASSE C.to C.
30060Z09700	97x33	-
30060Z097V0	33x97	-
30060Z035V0	33x35	-

CODICE Code	MISURE Overall size	INTERASSE C.to C.
06331.06400	97x42	64
06331.06401	97x42	64
09229.03200	32x41	-
12237.09700	33x97	-
12237.09701	33x97	-

CODICE Code	MISURE Overall size	INTERASSE C.to C.
30702.097V0	33x97	-
30702.09700	97x33	-

Liberty

Serie realizzabile in tutte le finiture indicate a catalogo / Series available in all finishes in the catalogue.

Liberty

Serie realizzabile in tutte le finiture indicate a catalogo / Series available in all finishes in the catalogue.

Finitura / Finish: 03 - Ottone antico / Antique brass

Ottone / Brass

Finitura / Finish: 09 - Firenze

Zama / Zamak

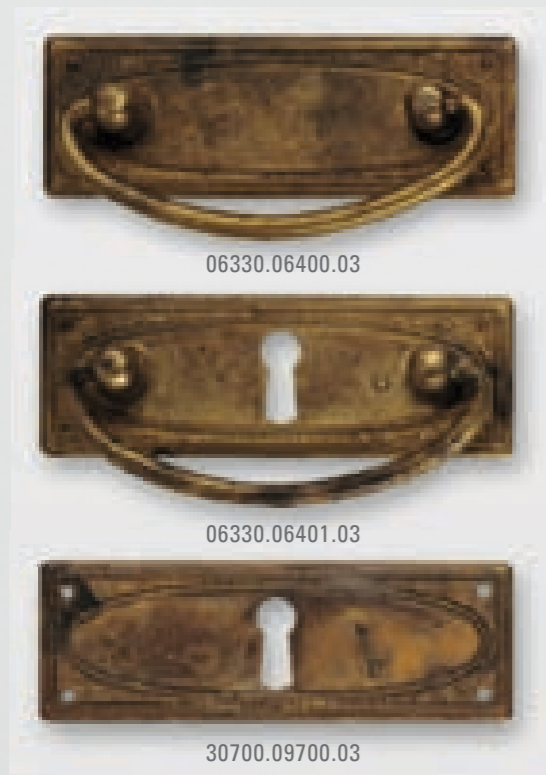

CODICE Code	MISURE Overall size	INTERASSE C.to C.
06330.06400	97x45	64
06330.06401	97x45	64
12232.09700	33x97	-
12232.09701	33x97	-
30700.097V0	33x97	-
30700.09700	97x33	-

CODICE Code	MISURE Overall size	INTERASSE C.to C.
06330Z06400	97x45	64
12232Z09700	33x97	-
12232Z09701	33x97	-
30700Z097V0	33x97	-
30700Z09700	97x33	-

Liberty

Serie realizzabile in tutte le finiture indicate a catalogo / Series available in all finishes in the catalogue.

Liberty

Serie realizzabile in tutte le finiture indicate a catalogo / Series available in all finishes in the catalogue.

Finitura / Finish: 09 - Firenze



12326Z09700.09



06332Z06400.09



06332Z06401.09

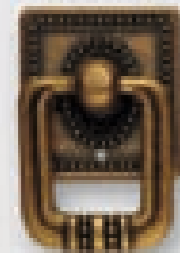

12326Z03500.09



30712Z09700.09



12326Z09701.09



30712Z097V0.09

Finitura / Finish: 03 - Ottone antico / Antique brass



18328.06400.03



18328.04800.03



18328.03200.03



18328.06401.03



18328.04801.03



18328.03201.03

CODICE Code	MISURE Overall size	INTERASSE C.to C.
06332Z06400	97x43	64
06332Z06401	97x43	64
12326Z03500	33x51	-
12326Z09700	33x97	-
12326Z09701	33x97	-

CODICE Code	MISURE Overall size	INTERASSE C.to C.
30712Z097V0	33x97	-
30712Z09700	97x33	-

CODICE Code	MISURE Overall size	INTERASSE C.to C.
18328.06401	100x43	64
18328.06400	100x43	64
18328.04801	80x35	48
18328.04800	80x35	48
18328.03201	60x28	32
18328.03200	60x28	32

Liberty

Serie realizzabile in tutte le finiture indicate a catalogo / Series available in all finishes in the catalogue.

C.328

Stile

Finitura / Finish: 03 - Ottone antico / Antique brass



18329.08800.03

18329.06800.03



25102.08000.03

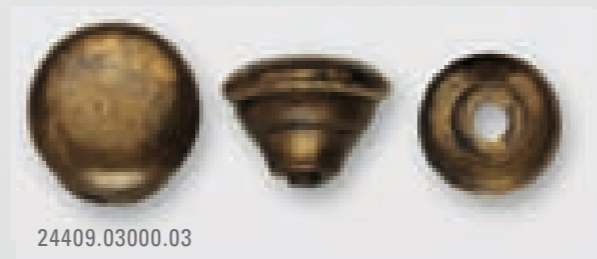

24409.03000.03



24409.02500.03

Liberty

Serie realizzabile in tutte le finiture indicate a catalogo / Series available in all finishes in the catalogue.

C.329

Stile

Finitura / Finish: 03 - Ottone antico / Antique brass



18329.06801.03

18329.08801.03

30699.088V0.03

30699.068V0.03



30698.10000.03



30698.08000.03



30698.06000.03

CODICE <i>Code</i>	MISURE <i>Overall size</i>	INTERASSE <i>C. to C.</i>
18329.06800	20x68	-
18329.08800	25x88	-
24409.03000	30x24	Ø 30
24409.02500	25x20	Ø 20
25102.08000	80x35	-

CODICE <i>Code</i>	MISURE <i>Overall size</i>	INTERASSE <i>C. to C.</i>
18329.06801	20x68	-
18329.08801	25x88	-
30698.10000	100x43	-
30698.08000	80x35	-

CODICE <i>Code</i>	MISURE <i>Overall size</i>	INTERASSE <i>C. to C.</i>
30698.06000	60x28	-
30699.088V0	25x88	-
30699.068V0	20x68	-

Luigi XV

Serie realizzabile in tutte le finiture indicate a catalogo / Series available in all finishes in the catalogue.

Finitura / Finish: 54 - Patiné bm



15135.11500.54



24452Z03500.54



09204.06000.54



09204.04500.54



24452Z03000.54



24452Z02500.54



30631.062V0.54



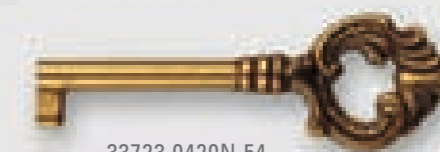

30631.06200.54



33723.0420N.54



24452Z02000.54

CODICE <i>Code</i>	MISURE <i>Overall size</i>	INTERASSE <i>C. to C.</i>	CODICE <i>Code</i>	MISURE <i>Overall size</i>	INTERASSE <i>C. to C.</i>
09204.06000	60x76	-	24452Z02000	20x19	Ø 20
09204.04500	45x57	-	30631.062V0	29x62	-
15135.11500	115x45	64	30631.06200	62x29	-
24452Z03500	35x28	Ø 35	33723.0420N	28x88	N 42 
24452Z03000	30x26	Ø 30	33723.0340N	28x80	N 34 
24452Z02500	25x23	Ø 25			

Luigi XV

Serie realizzabile in tutte le finiture indicate a catalogo / Series available in all finishes in the catalogue.

C.332

Stile

Finitura / Finish: 54 - Patinè bm



24452Z03500.54



15107.13600.54



24452Z03000.54

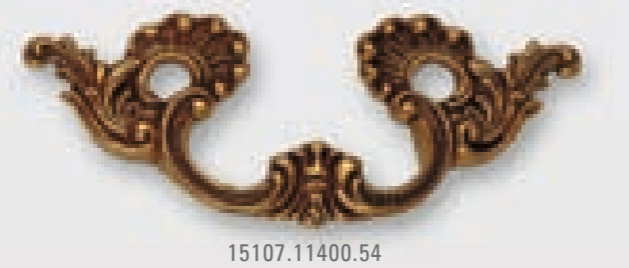

15107.11400.54



24452Z.02500.54

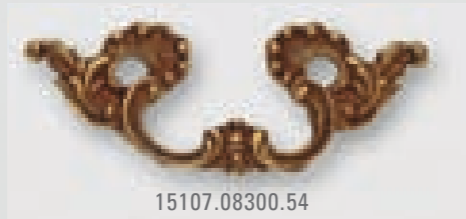

15107.08300.54



24452Z02000.54

Luigi XV

Serie realizzabile in tutte le finiture indicate a catalogo / Series available in all finishes in the catalogue.

C.333

Stile

Finitura / Finish: 54 - Patinè bm



30605.200S0.54



30605.200D0.54



30605.163S0.54



30605.163D0.54



30605.091S0.54



30605.091D0.54



30605.08500.54



33710.0420N.54

CODICE Code	MISURE Overall size	INTERASSE C.to C.	CODICE Code	MISURE Overall size	INTERASSE C.to C.
15107.13600	136x54	64	24452Z03000	30x26	Ø 30
15107.11400	114x44	64	24452Z02500	25x23	Ø 25
15107.08300	83x33	40	24452Z02000	20x19	Ø 20
24452Z03500	35x28	Ø 35			

CODICE Code	MISURE Overall size	INTERASSE C.to C.	CODICE Code	MISURE Overall size	INTERASSE C.to C.
30605.200S0	26x200	-	30605.091D0	17x91	-
30605.200D0	26x200	-	30605.08500	85x24	-
30605.163S0	22x163	-	33710.0340N	31x81	N 34
30605.163D0	22x163	-	33710.0420N	33x85	N 42
30605.091S0	17x91	-			

Luigi XV

Serie realizzabile in tutte le finiture indicate a catalogo / Series available in all finishes in the catalogue.

Luigi XV

Serie realizzabile in tutte le finiture indicate a catalogo / Series available in all finishes in the catalogue.

Finitura / Finish: 54 - Patinè bm



30640.148S0.54 30640.148D0.54

15109Z09600.54

24410Z03500.54

15109Z06400.54

24410Z03000.54

30631.062V0.54

30631.06200.54

24410Z02500.54

33723.0420N.54

Finitura / Finish: 25 - Argento vecchio / Old silver



15106Z17700.25

15106Z13100.25

CODICE Code	MISURE Overall size	INTERASSE C.to C.
15109Z09600	159x36	96
15109Z06400	99x25	64
24410Z03500	35x28	Ø 35
24410Z03000	30x24	Ø 30
24410Z02500	25x22	Ø 25

CODICE Code	MISURE Overall size	INTERASSE C.to C.
30631.062V0	29x62	25
30631.06200	62x29	20
30640.148D0	20x148	N 42
30640.148S0	20x148	-
33723.0420N	28x88	N 42
33723.0340N	28x88	N 34

CODICE Code	MISURE Overall size	INTERASSE C.to C.
15106Z17700	177x52	96
15106Z13100	131x39	64

Luigi XV

Serie realizzabile in tutte le finiture indicate a catalogo / Series available in all finishes in the catalogue.

C.336

Stile

Finitura / Finish: 54 - Patinè bm

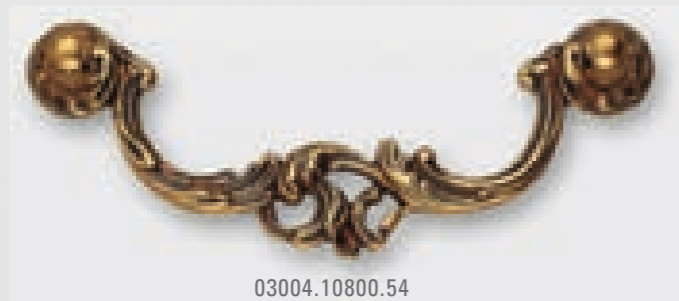

03004.10800.54



03004.08700.54

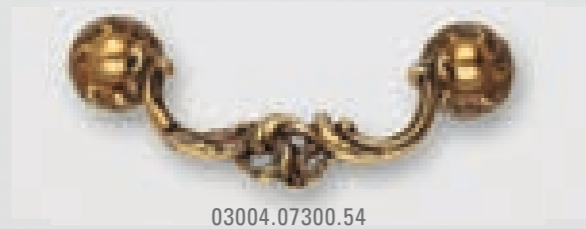

03004.07300.54

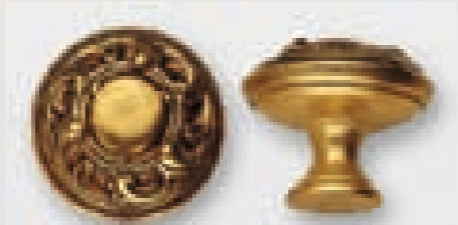

24401Z03500.54

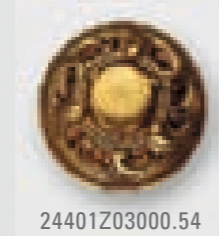

24401Z03000.54



24401Z02500.54



35724.04600.54



37724.05000.54

Luigi XV

Serie realizzabile in tutte le finiture indicate a catalogo / Series available in all finishes in the catalogue.

C.337

Stile

Finitura / Finish: 54 - Patinè bm



30639.131S0.54



30639.131D0.54



30639.090S0



30639.090D0

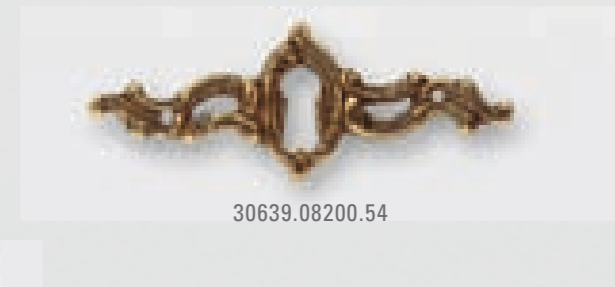

30639.08200.54

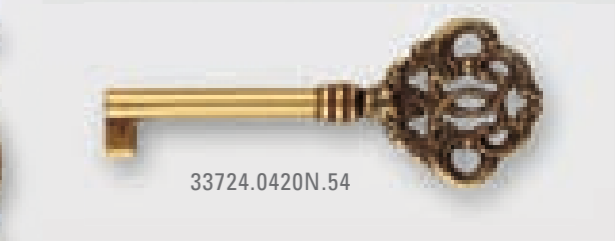

33724.0420N.54

CODICE Code	MISURE Overall size	INTERASSE C.to C.
03004.10800	128x51	108
03004.08700	108x45	87
03004.07300	93x38	73
24401Z03500	35x29	Ø 35
24401Z03000	30x24	Ø 30

CODICE Code	MISURE Overall size	INTERASSE C.to C.
24401Z02500	25x23	Ø 25
35724.04600	33x46	-
37724.05000	33x59	-

CODICE Code	MISURE Overall size	INTERASSE C.to C.
30639.08200	81x30	-
30639.090D0	16x90	-
30639.090S0	16x90	-
30639.131D0	23x131	-

CODICE Code	MISURE Overall size	INTERASSE C.to C.
30639.131S0	23x131	-
33724.0420N	33x85	N 42
33724.0340N	33x77	N 34

Luigi XV

Serie realizzabile in tutte le finiture indicate a catalogo / Series available in all finishes in the catalogue.

Luigi XVI

Serie realizzabile in tutte le finiture indicate a catalogo / Series available in all finishes in the catalogue.

Finitura / Finish: 54 - Patinè bm

Finitura / Finish: 54 - Patinè bm
09 - Florence



15331.09600.54

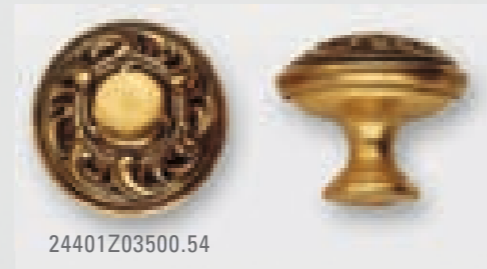

24401Z03500.54

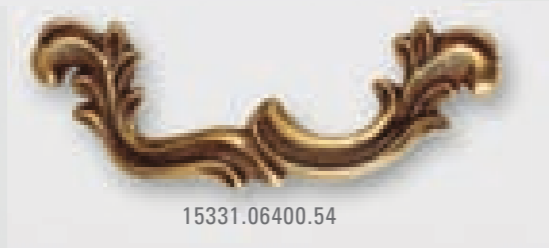

15331.06400.54

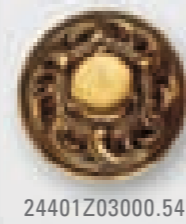

24401Z03000.54



30614.071V0.54

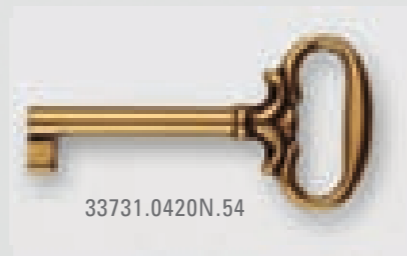

33731.0420N.54

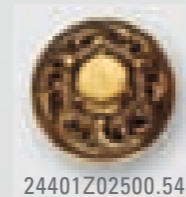

24401Z02500.54

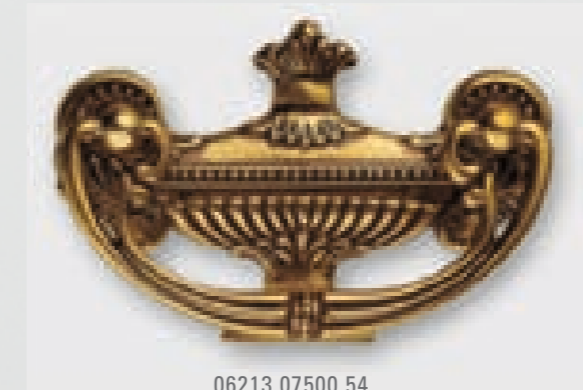

06213.07500.54



06214.08000.54



03213.07500.54



12020Z07200.09

CODICE Code	MISURE Overall size	INTERASSE C.to C.
15331.09600	143x50	96
15331.06400	96x32	64
24401Z03500	35x29	35
24401Z03000	30x24	30
24401Z02500	25x23	25
30614.071V0	15x71	-

CODICE Code	MISURE Overall size	INTERASSE C.to C.
33731.0420N	35x69	N 42 
33731.0340N	35x61	N 34 

CODICE Code	MISURE Overall size	INTERASSE C.to C.
03213.07500	105x60	75
06213.07500	100x65	75
06214.08000	80x60	32
12020Z07200	72x46	32

Luigi XVI

Serie realizzabile in tutte le finiture indicate a catalogo / Series available in all finishes in the catalogue.

Luigi XVI

Serie realizzabile in tutte le finiture indicate a catalogo / Series available in all finishes in the catalogue.

Finitura / Finish: 54 - Patinè bm

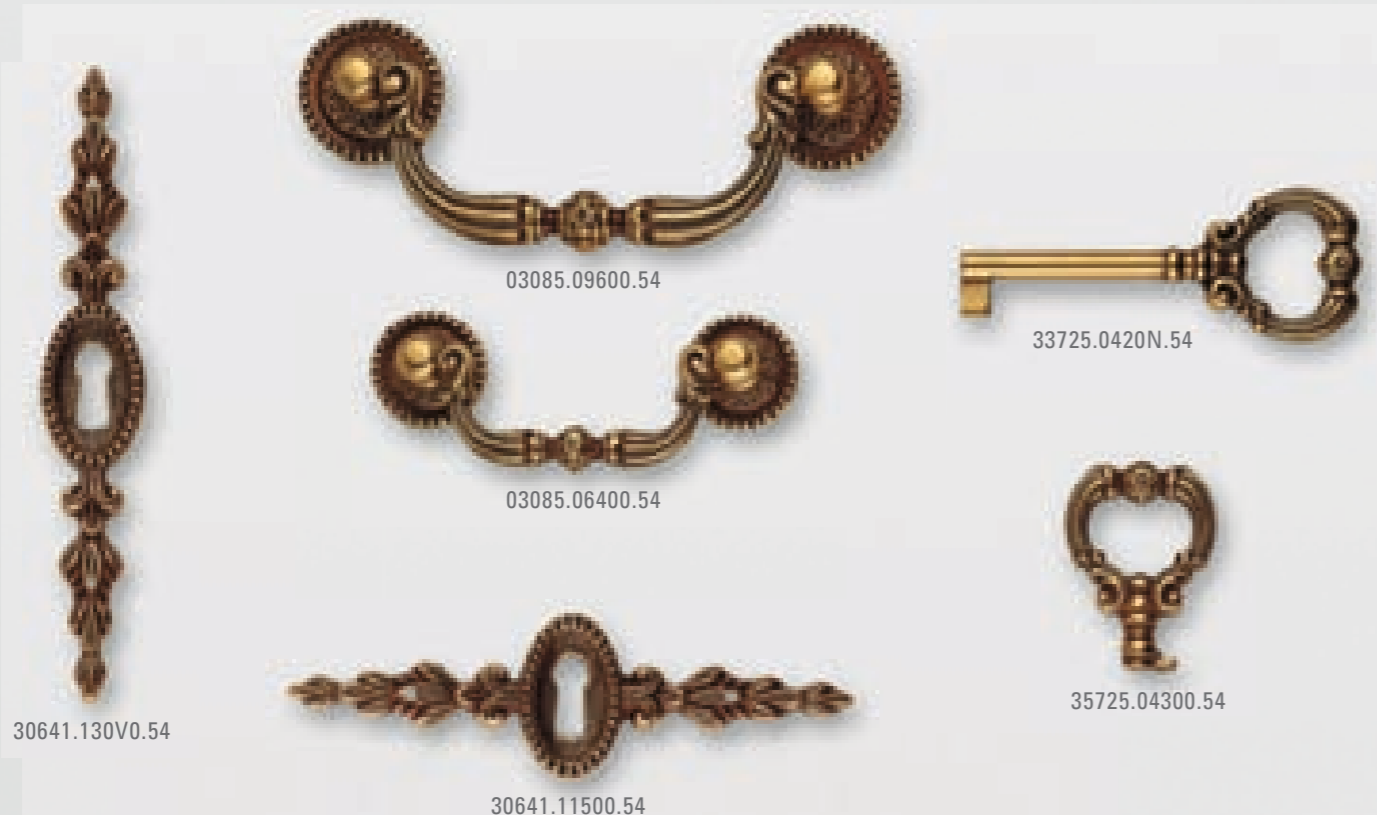

Finitura / Finish: 54 - Patinè bm



CODICE Code	MISURE Overall size	INTERASSE C.to C.	CODICE Code	MISURE Overall size	INTERASSE C.to C.	CODICE Code	MISURE Overall size	INTERASSE C.to C.	CODICE Code	MISURE Overall size	INTERASSE C.to C.
03085.09600	123x50	96	33725.0530N	31x92	N 53	22208.15700	33x157	-	24479Z02500	25x20	Ø 25
03085.06400	86x33	64	33725.0420N	31x81	N 42	22208.15701	33x157	-	24479Z02000	20x18	Ø 20
30641.11500	115x34	-	33725.0340N	31x73	N 34	22208.12200	33x122	-	37725.04500	31x57	-
30641.130V0	22x130	-				22208.12201	33x122	-			
35725.04300	31x43	-				24479Z03500	35x26	Ø 35			
						24479Z03000	30x23	Ø 30			

Luigi XVI

Serie realizzabile in tutte le finiture indicate a catalogo / Series available in all finishes in the catalogue.

Luigi XVI



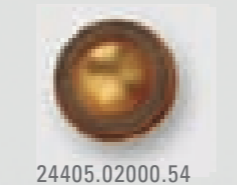
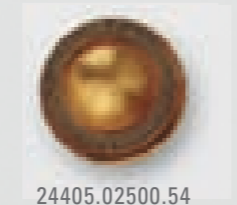
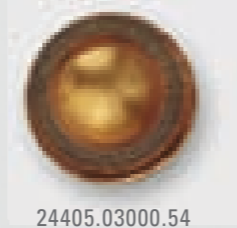
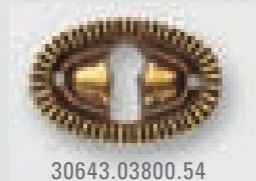
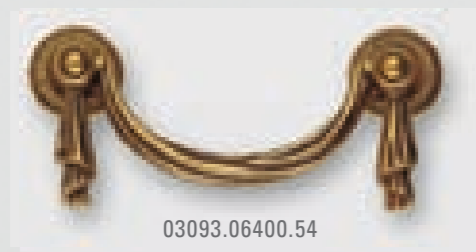
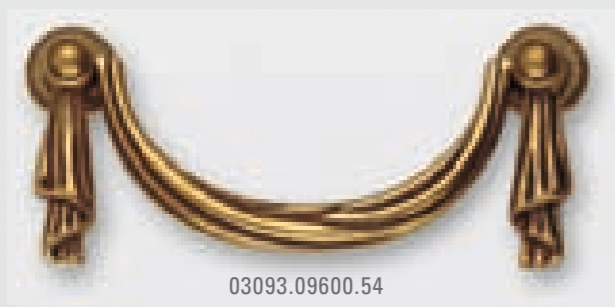

Serie realizzabile in tutte le finiture indicate a catalogo / Series available in all finishes in the catalogue.

Finitura / Finish: 54 - Patinè bm



Finitura / Finish: 54 - Patinè bm



CODICE Code	MISURE Overall size	INTERASSE C.to C.	CODICE Code	MISURE Overall size	INTERASSE C.to C.
03093.09600	115x51	96	30643.038V0	25x38	-
03093.06400	84x40	64	30643.03800	38x25	-
24405.03500	35x25	35	33726.0530N	24x87	N 53 
24405.03000	30x20	30	33726.0420N	24x76	N 42 
24405.02500	25x17	25	33726.0340N	24x68	N 34 
24405.02000	20x16	20	33726.0240N	24x58	N 24 

CODICE Code	MISURE Overall size	INTERASSE C.to C.
21391.05200	20x62	-
21391.06200	20x72	-
22203.16000	29x160	-
22203.12400	22x124	-

Luigi XVI

Serie realizzabile in tutte le finiture indicate a catalogo / Series available in all finishes in the catalogue.

C.344

Stile

Finitura / Finish: 54 - Patinè bm

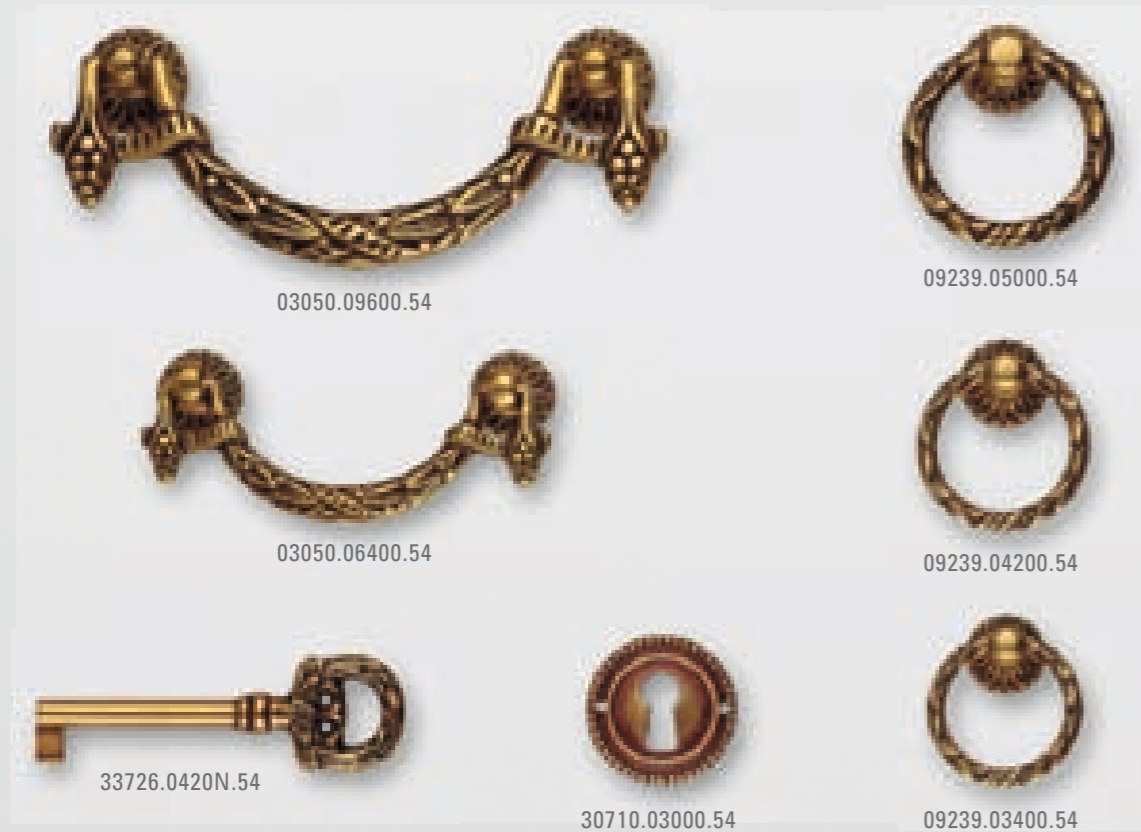

Luigi XVI

Serie realizzabile in tutte le finiture indicate a catalogo / Series available in all finishes in the catalogue.

C.345

Stile

Finitura / Finish: 54 - Patinè bm



CODICE Code	MISURE Overall size	INTERASSE C. to C.	CODICE Code	MISURE Overall size	INTERASSE C. to C.
03050.09600	126x53	96	33726.0530N	24x87	N 53
03050.06400	85x37	64	33726.0420N	24x76	N 42
09239.05000	50x57	-	33726.0340N	24x68	N 34
09239.04200	42x49	-	33726.0240N	24x58	N 24
09239.03400	34x51	-			
30710.03000	-	Ø 30			

CODICE Code	MISURE Overall size	INTERASSE C. to C.
21392.04900	18x59	-
21392.06000	22x71	-
22207.15700	29x157	-
22207.12200	22x124	-

Luigi XVI

Serie realizzabile in tutte le finiture indicate a catalogo / Series available in all finishes in the catalogue.

Luigi XVI

Serie realizzabile in tutte le finiture indicate a catalogo / Series available in all finishes in the catalogue.

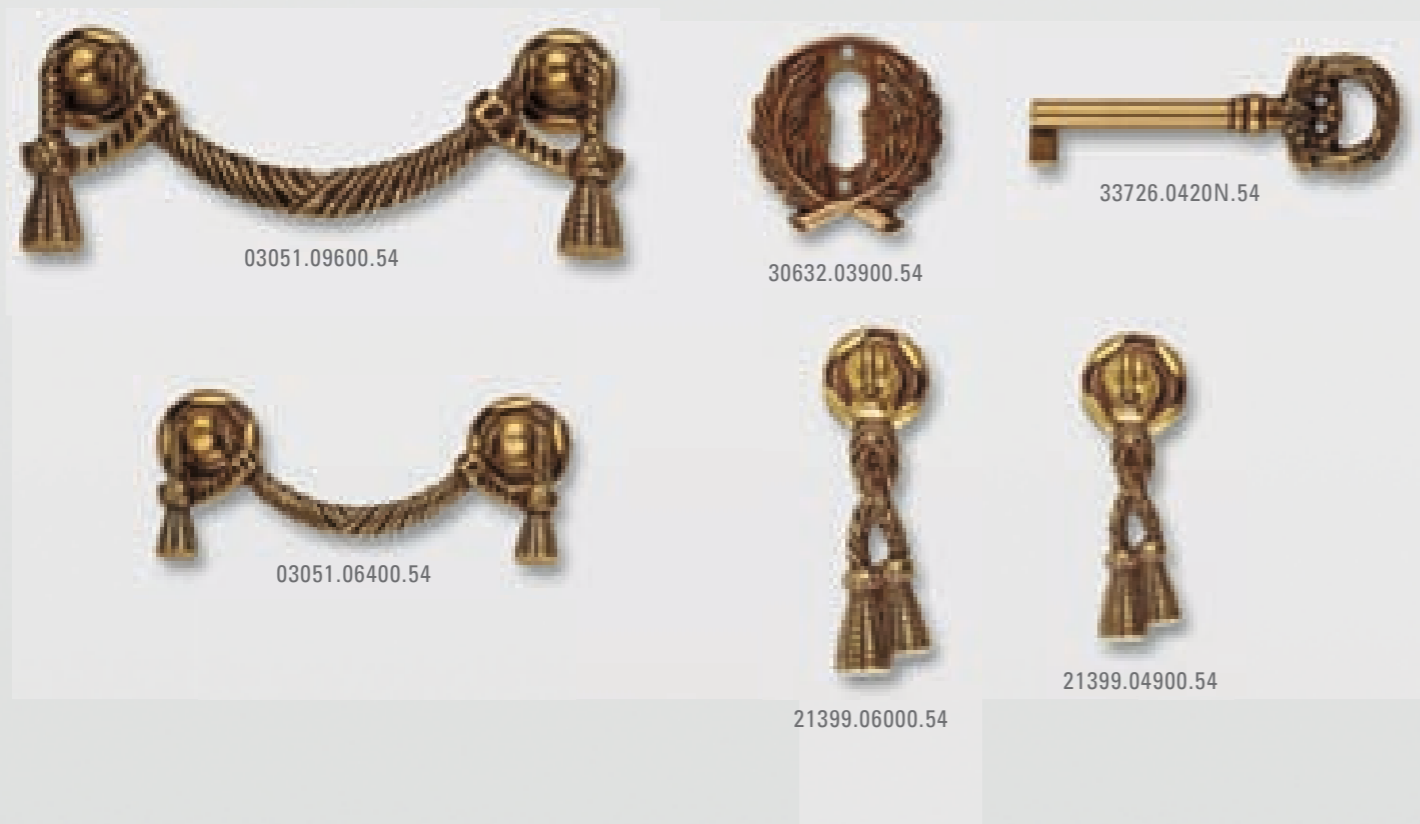

Finitura / Finish: 54 - Patinè bm

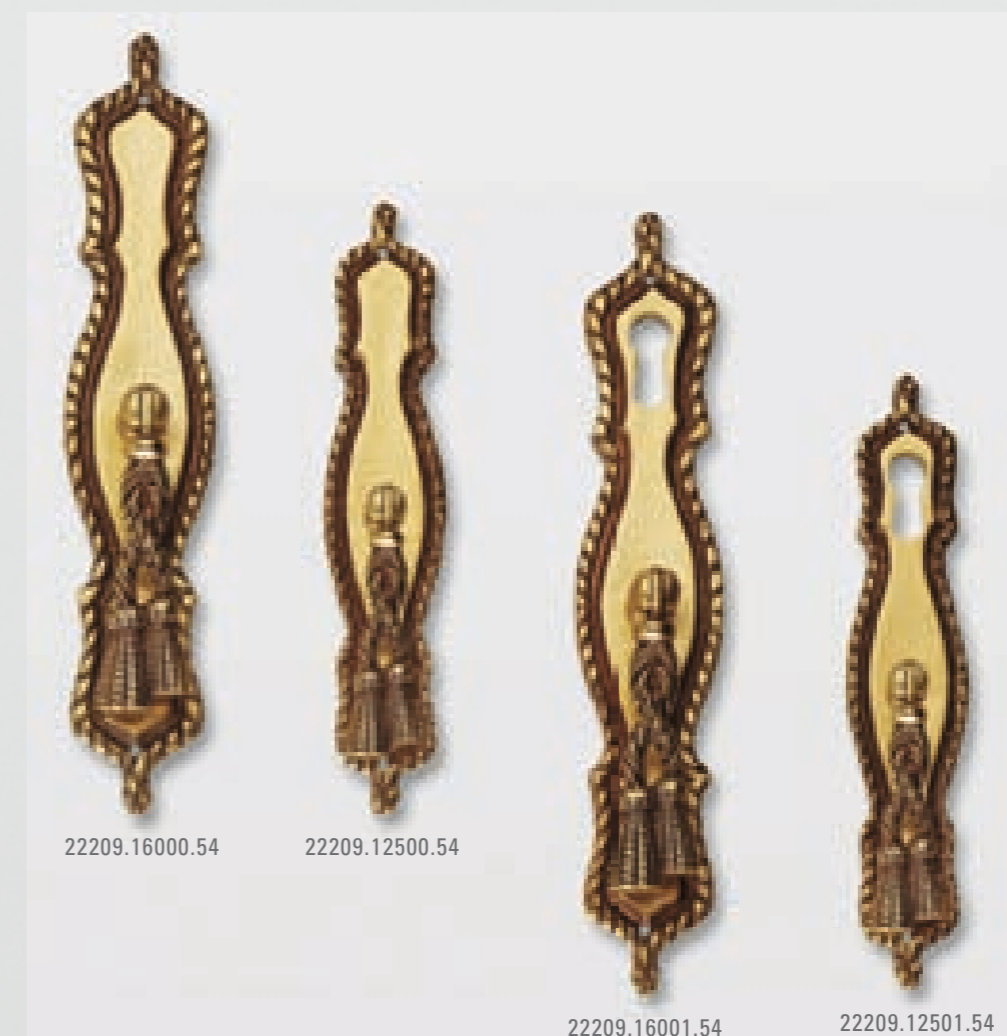

Finitura / Finish: 54 - Patinè bm



CODICE Code	MISURE Overall size	INTERASSE C.to C.
03051.09600	123x53	96
03051.06400	85x37	64
21399.06000	22x72	-
21399.04900	22x62	-
30632.03900	39x39	-

CODICE Code	MISURE Overall size	INTERASSE C.to C.
33726.0530N	24x87	N 53 
33726.0420N	24x76	N 42 
33726.0340N	24x68	N 34 
33726.0240N	24x58	N 24 

CODICE Code	MISURE Overall size	INTERASSE C.to C.
22209.16000	32x160	-
22209.16001	32x160	-
22209.12500	25x125	-
22209.12501	25x125	-

Luigi XVI

Serie realizzabile in tutte le finiture indicate a catalogo / Series available in all finishes in the catalogue.

Luigi XVI

Serie realizzabile in tutte le finiture indicate a catalogo / Series available in all finishes in the catalogue.

Finitura / Finish: 07 - OroValenza



Finitura / Finish: 54 - Patinè bm

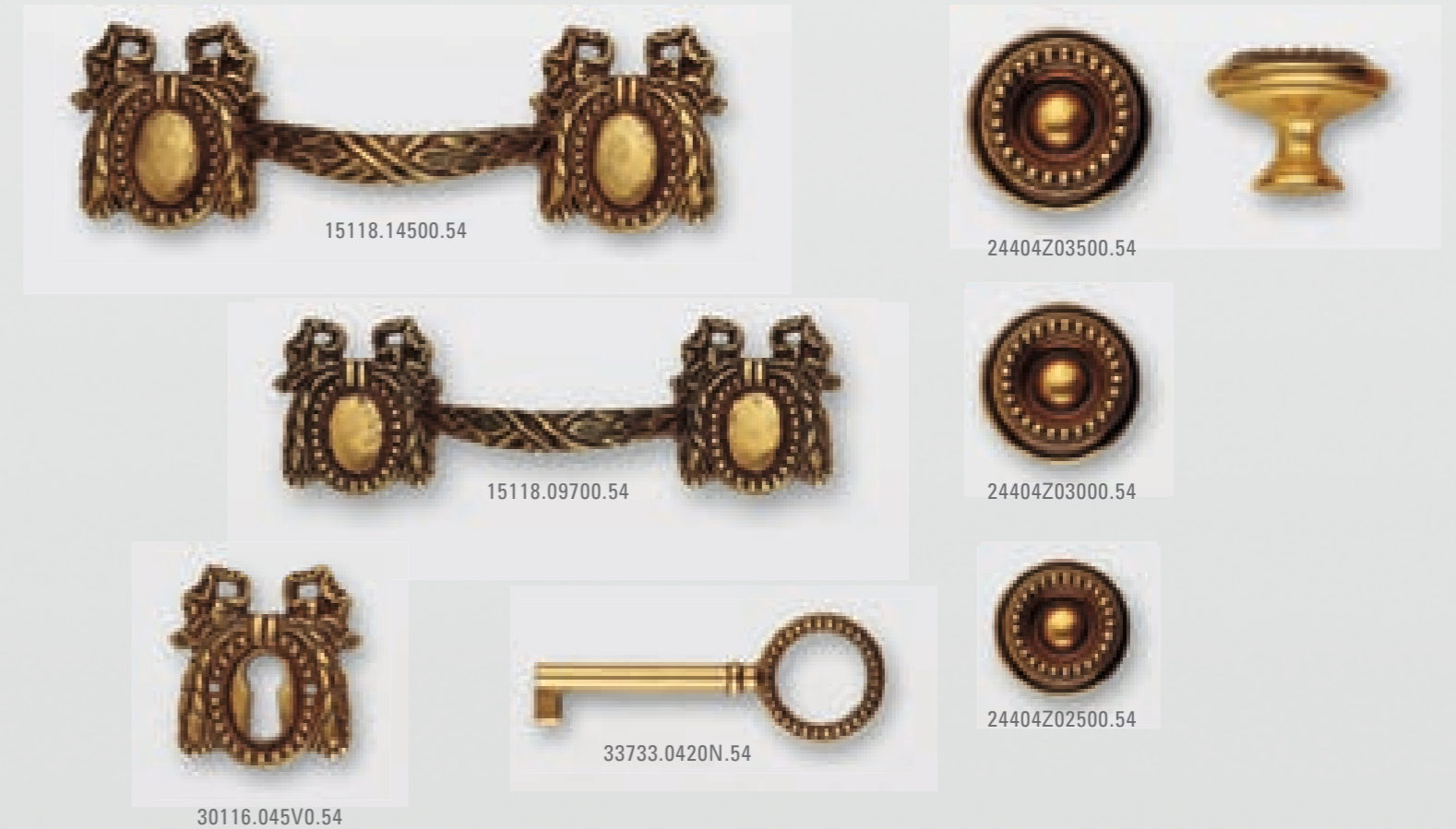

CODICE Code	MISURE Overall size	INTERASSE C.to C.
24261Z07900	79x44x25	32
24261Z06400	64x36x25	-

CODICE Code	MISURE Overall size	INTERASSE C.to C.
15118.14500	145x46	64
15118.09700	97x30	64
24404Z03500	35x25	Ø 35
24404Z03000	30x23	Ø 30
24404Z02500	25x21	Ø 25
30116.045V0	43x45	-

CODICE Code	MISURE Overall size	INTERASSE C.to C.
33733.0530N	28x88	N 53
33733.0420N	28x77	N 42
33733.0340N	28x69	N 34

Luigi XVI

Serie realizzabile in tutte le finiture indicate a catalogo / Series available in all finishes in the catalogue.

C.350

Stile

Finitura / Finish: 54 - Patiné BM



Luigi XVI

Serie realizzabile in tutte le finiture indicate a catalogo / Series available in all finishes in the catalogue.

C.351

Stile

Finitura / Finish: 54 - Patiné BM



CODICE Code	MISURE Overall size	INTERASSE C.to C.
15119Z12800	160x51	128
15119Z09600	120x38	96
15119Z06400	80x30	64
21119Z06000	71x21	-

CODICE Code	MISURE Overall size	INTERASSE C.to C.
21119Z04900	61x20	-
22119Z14500	29x145	-
22119Z12000	25x120	-

CODICE Code	MISURE Overall size	INTERASSE C.to C.
18119Z12800	160x66	128
18119Z09600	120x50	96
18119Z06400	80x37	64
22119Z14501	29x145	-
22119Z12001	25x120	-

CODICE Code	MISURE Overall size	INTERASSE C.to C.
24223Z03000	30x22	Ø 30
24223Z02500	25x20	Ø 25
30733Z037V0	25x37	-

Luigi XVI

Serie realizzabile in tutte le finiture indicate a catalogo / Series available in all finishes in the catalogue.

C.352

Stile

Finitura / Finish: 54 - Patinè bm



12210.06600.54



12210.05000.54

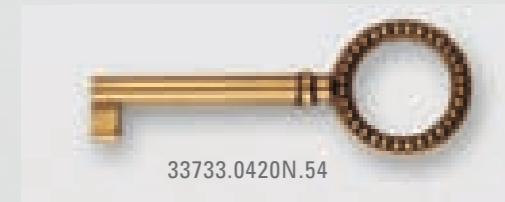

33733.0420N.54



30607.05000.54

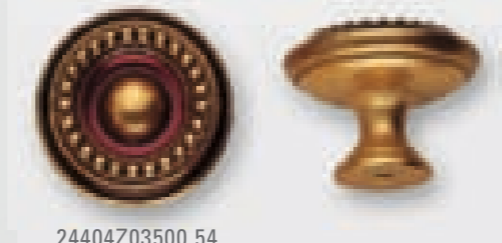

24404Z03500.54



24404Z03000.54

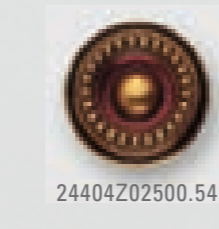

24404Z02500.54

Luigi XVI

Serie realizzabile in tutte le finiture indicate a catalogo / Series available in all finishes in the catalogue.

C.353

Stile

Finitura / Finish: 54 - Patinè bm



12236.07000.54



12236.06000.54



12236.05000.54

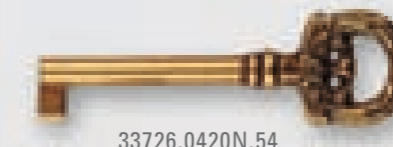

33726.0420N.54



30645.048V0.54



24405.03500.54



24405.03000.54

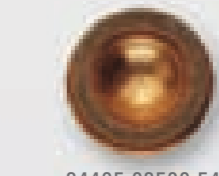

24405.02500.54



24405.02000.54

CODICE Code	MISURE Overall size	INTERASSE C.to C.	CODICE Code	MISURE Overall size	INTERASSE C.to C.	CODICE Code	MISURE Overall size	INTERASSE C.to C.	CODICE Code	MISURE Overall size	INTERASSE C.to C.
12210.06600	66x58	-	33733.0530N	28x88	N 53	12236.07000	62x70	-	24405.02000	20x16	Ø 20
12210.05000	50x43	-	33733.0420N	28x77	N 42	12236.06000	52x60	-	30645.048V0	34x48	-
24404Z03500	35x25	Ø 35	33733.0340N	28x69	N 34	12236.05000	43x50	-	33726.0530N	24x87	N 53
24404Z03000	30x23	Ø 30				24405.03500	35x25	Ø 35	33726.0420N	24x76	N 42
24404Z02500	25x21	Ø 25				24405.03000	30x20	Ø 30	33726.0340N	24x68	N 34
30607.05000	50x43	-				24405.02500	25x17	Ø 25	33726.0240N	24x58	N 24

Luigi XVI

Serie realizzabile in tutte le finiture indicate a catalogo / Series available in all finishes in the catalogue.

Luigi XVI

Serie realizzabile in tutte le finiture indicate a catalogo / Series available in all finishes in the catalogue.

Finitura / Finish: 54 - Patinè bm

Finitura / Finish: 54 - Patiné BM

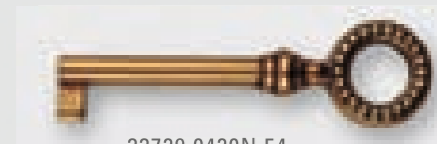

33729.0420N.54

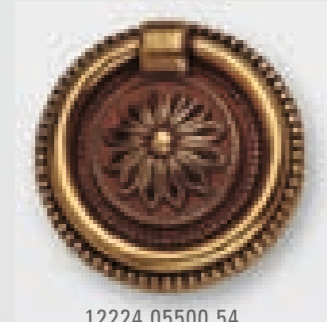

12224.05500.54



24479Z03500.54



30642.035V0.54



12224.04700.54



24479Z03000.54



30642.03500.54



12224.03700.54

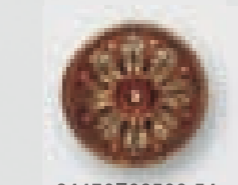

24479Z02500.54



12224.03200.54



24479Z02000.54



12330.06200.54

12330.05200.54

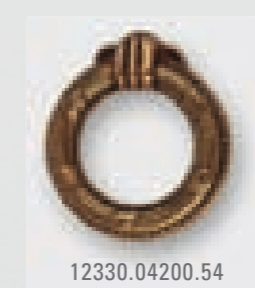

12330.04200.54

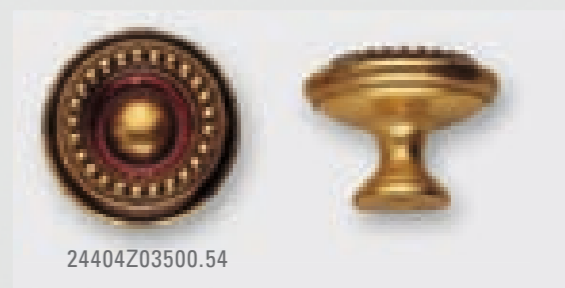

24404Z03500.54

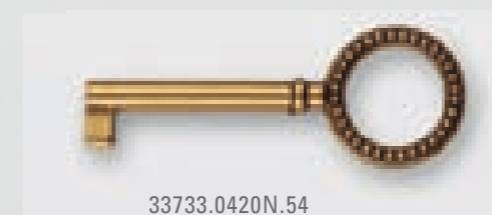

33733.0420N.54

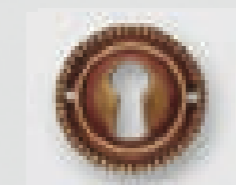

30710.03000.54

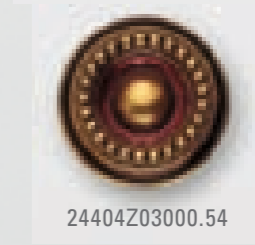

24404Z03000.54

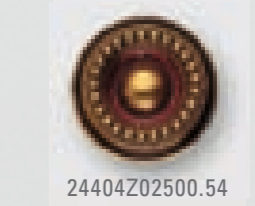

24404Z02500.54

CODICE Code	MISURE Overall size	INTERASSE C.to C.	CODICE Code	MISURE Overall size	INTERASSE C.to C.	CODICE Code	MISURE Overall size	INTERASSE C.to C.	CODICE Code	MISURE Overall size	INTERASSE C.to C.
12224.05500	-	Ø 55	24479Z02000	20x18	Ø 20	12330.06200	56x62	-	30710.03000	-	Ø 30
12224.04700	-	Ø 47	30642.035V0	22x35	-	12330.05200	47x52	-	33733.0530N	28x88	N 53
12224.03700	-	Ø 37	30642.03500	35x22	-	12330.04200	38x42	-	33733.0420N	28x77	N 53
12224.03200	-	Ø 32	33729.0420N	22x76	N 42	24404Z03500	35x25	35	33733.0340N	28x69	N 34
24479Z03500	35x26	Ø 35	33729.0340N	22x68	N 34	24404Z03000	30x23	30			
24479Z03000	30x23	Ø 30	33729.0240N	22x58	N 24	24404Z02500	25x21	25			
24479Z02500	25x20	Ø 25									



Luigi XVI

Serie realizzabile in tutte le finiture indicate a catalogo / Series available in all finishes in the catalogue.

C.356

Stile

Finitura / Finish: 07 - Oro di Valenza



30733Z037V0.07



12350Z03900.07



12350Z04900.07

Luigi XVI

Serie realizzabile in tutte le finiture indicate a catalogo / Series available in all finishes in the catalogue.

C.357

Stile

Finitura / Finish: 07 - Oro di Valenza



45255Z02301.07



45255Z02801.07



45255Z03501.07



45255Z04301.07



45255Z05001.07



24264Z02000.07



24264Z03000.07



24264Z04000.07



CODICE Code	MISURE Overall size	INTERASSE C.to C.
12350Z04900	49x49	Ø 49
12350Z03900	39x39	Ø 39
30733Z037V0	25x37	-

CODICE Code	MISURE Overall size	INTERASSE C.to C.
24264Z04000	40x26	Ø 40
24264Z03000	30x24	Ø 30
24264Z02000	20x20	Ø 20
45255Z05001	50x18	Ø 50
45255Z04301	43x17	Ø 43

CODICE Code	MISURE Overall size	INTERASSE C.to C.
45255Z03501	35x16	Ø 35
45255Z02801	28x15	Ø 28
45255Z02301	23x14	Ø 23



Luigi XVI

Serie realizzabile in tutte le finiture indicate a catalogo / Series available in all finishes in the catalogue.

Finitura / Finish: 09 - Florence

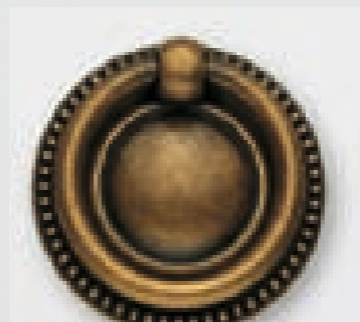

12212Z06000.09



12212Z05000.09



12212Z04000.07



45984Z04500.09



30112Z02701.09

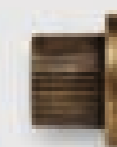

30112Z02700.09



24222Z03000.09



24222Z02500.09

CODICE <i>Code</i>	MISURE <i>Overall size</i>	INTERASSE <i>C.to C.</i>	CODICE <i>Code</i>	MISURE <i>Overall size</i>	INTERASSE <i>C.to C.</i>
12212Z06000	-	Ø 60	30112Z02700	27x27x15	Ø 19
12212Z05000	-	Ø 50	30112Z02701	27x27x15	Ø 19
12212Z04000	-	Ø 40	45984Z04500	45x45	-
24222Z03000	30x22	Ø 30			
24222Z02500	25x20	Ø 25			

Luigi XVI

Serie realizzabile in tutte le finiture indicate a catalogo / Series available in all finishes in the catalogue.

C.360

Stile

Finitura / Finish: 54 - Patinè bm



12238.06000.54

09238.05000.54

30703.04100.54

12238.05000.54

09238.04200.54

33727.0420N.54

12238.04000.54

09238.03400.54

Luigi XVI

Serie realizzabile in tutte le finiture indicate a catalogo / Series available in all finishes in the catalogue.

C.361

Stile

Finitura / Finish: 54 - Patinè bm



12235.05500.54

09236.05000.54

30642.035V0.54

30642.03500.54

12235.04700.54

09236.04200.54

33729.0420N.54

12235.03700.54

09236.03400.54

CODICE Code	MISURE Overall size	INTERASSE C.to C.	CODICE Code	MISURE Overall size	INTERASSE C.to C.	CODICE Code	MISURE Overall size	INTERASSE C.to C.	CODICE Code	MISURE Overall size	INTERASSE C.to C.
09238.05000	50x67	-	30703.04100	-	Ø 41	09236.05000	50x57	-	30642.035V0	22x35	-
09238.04200	42x57	-	33727.0340N	27x61	N 34	09236.04200	42x49	-	30642.03500	35x22	-
09238.03400	38x48	-	33727.0240N	27x51	N 24	09236.03400	34x43	-	33729.0420N	22x76	N 42
12238.06000	-	Ø 60	33727.0420N	27x69	N 42	12235.05500	-	Ø 55	33729.0340N	22x68	N 34
12238.05000	-	Ø 50				12235.04700	-	Ø 47	33729.0240N	22x58	N 24
12238.04000	-	Ø 40				12235.03700	-	Ø 37			

Provenzale

Serie realizzabile in tutte le finiture indicate a catalogo / Series available in all finishes in the catalogue.

Provenzale

Serie realizzabile in tutte le finiture indicate a catalogo / Series available in all finishes in the catalogue.

Finitura / Finish: 03 - Ottone antico / Antique brass
09 - Florence

Finitura / Finish: 03 - Ottone antico / Antique brass



06311.09600.03



06025.09600.09



24499.04001.03



24499Z03500.03



24499Z03000.03



24499Z02500.03

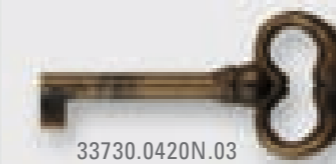

33730.0420N.03

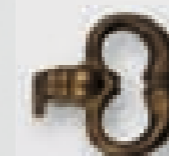

35730.03500.03



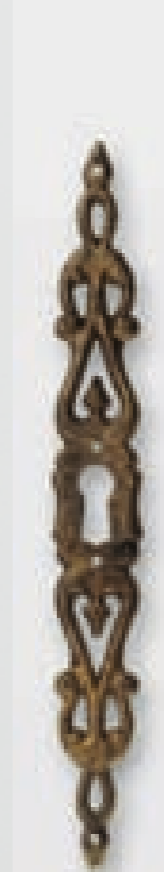

30638.238V0.03



30638.175V0.03

CODICE Code	MISURE Overall size	INTERASSE C.to C.
06025.09600	177x54	96
06311.09600	177x52	96
24499.04001	40x34	40
24499Z03500	35x28	35
24499Z03000	30x24	30
24499Z02500	25x21	25

CODICE Code	MISURE Overall size	INTERASSE C.to C.
30638.175V0	22x175	-
30638.238V0	30x238	-
33730.0420N	35x74	N 42 
33730.0340N	35x66	N 34 
35730.03500	35x35	-



Regency

Serie realizzabile in tutte le finiture indicate a catalogo / Series available in all finishes in the catalogue.

Finitura / Finish: 09 - Florence



06300.09600.09



03103.09600.09

03103.06400.09



06032Z06400.09

CODICE <i>Code</i>	MISURE <i>Overall size</i>	INTERASSE <i>C.to C.</i>
03103.09600	127x52	96
03103.06400	84x33	64
06300.09600	119x64	96
06032Z06400	95x64	64

Regency

Serie realizzabile in tutte le finiture indicate a catalogo / Series available in all finishes in the catalogue.

Regency

Serie realizzabile in tutte le finiture indicate a catalogo / Series available in all finishes in the catalogue.

Finitura / Finish: 09 - Firenze



06304.09600.09



21395Z04900.09



24406Z03500.03



24406Z03000.03



24406Z02500.03



06304.06400.09



35730.03500.09

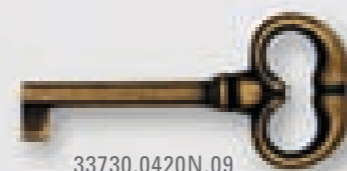

33730.0420N.09



30630.057V0.09

Finitura / Finish: 03 - Ottone antico / Antique brass



06313.09600.03



06313.06400.03

CODICE Code	MISURE Overall size	INTERASSE C.to C.
06304.09600	114x39	96
06304.06400	78x30	64
21395Z04900	20x59	-
24406Z03500	35x26	Ø 35
24406Z03000	30x24	Ø 30

CODICE Code	MISURE Overall size	INTERASSE C.to C.
24406Z02500	25x21	Ø 25
30630.057V0	20x57	-
33730.0420N	35x74	N 42
33730.0340N	35x66	N 34
35730.03500	35x35	-

CODICE Code	MISURE Overall size	INTERASSE C.to C.
06313.09600	120x57	96
06313.06400	80x35	64

Regency

Serie realizzabile in tutte le finiture indicate a catalogo / Series available in all finishes in the catalogue.

C.368

Stile

Finitura / Finish: 07 - Orodì Valenza



03037.09600.07

03037.06400.07



24408Z03500.07

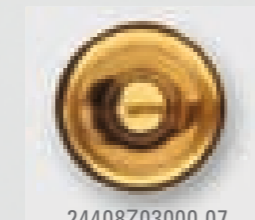

24408Z03000.07

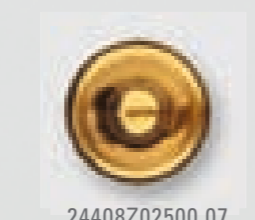

24408Z02500.07

Regency

Serie realizzabile in tutte le finiture indicate a catalogo / Series available in all finishes in the catalogue.

C.369

Stile

Finitura / Finish: 03 - Ottone antico / Antique brass

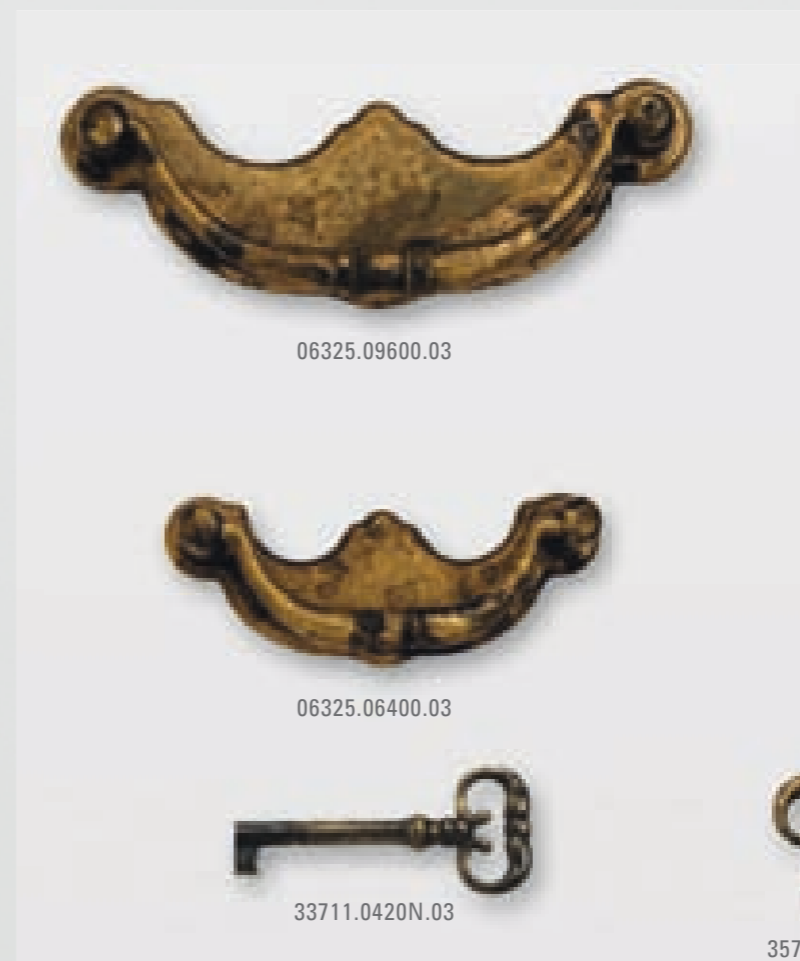

06325.09600.03

06325.06400.03

33711.0420N.03

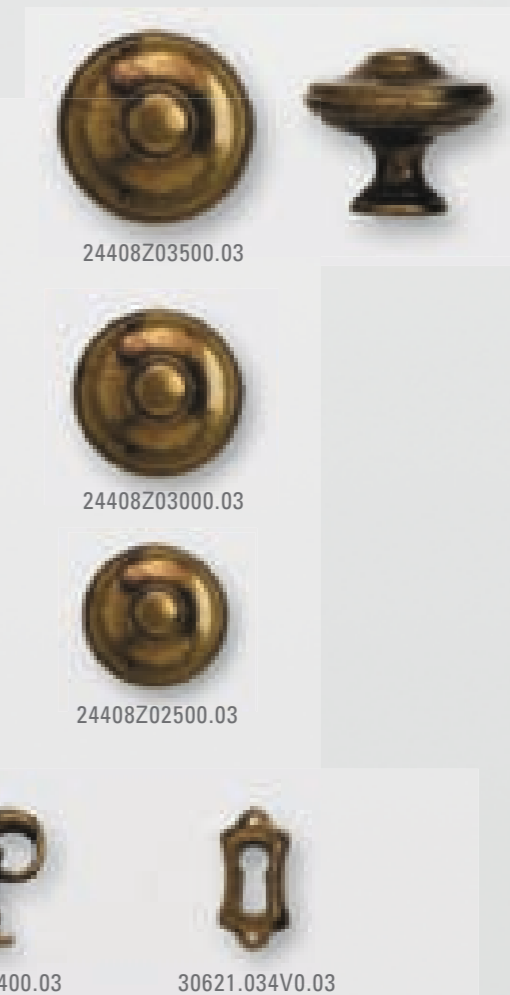

24408Z03500.03

24408Z03000.03

24408Z02500.03

35711.03400.03

30621.034V0.03

CODICE Code	MISURE Overall size	INTERASSE C.to C.
03037.09600	112x41	96
03037.06400	82x30	64
24408Z03500	35x30	Ø 35
24408Z03000	30x26	Ø 30
24408Z02500	25x23	Ø 25

CODICE Code	MISURE Overall size	INTERASSE C.to C.
06325.09600	114x41	96
06325.06400	78x30	64
24408Z03500	35x30	Ø 35
24408Z03000	30x26	Ø 30
24408Z02500	25x23	Ø 25
30621.034V0	17x34	-

CODICE Code	MISURE Overall size	INTERASSE C.to C.
35711.03400	32x34	-
33711.0530N	32x83	N 53
33711.0420N	32x72	N 42
33711.0340N	32x64	N 34

Regency

Serie realizzabile in tutte le finiture indicate a catalogo / Series available in all finishes in the catalogue.

Regency

Serie realizzabile in tutte le finiture indicate a catalogo / Series available in all finishes in the catalogue.

Finitura / Finish: 07 - Oro di Valenza

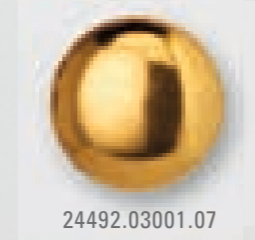
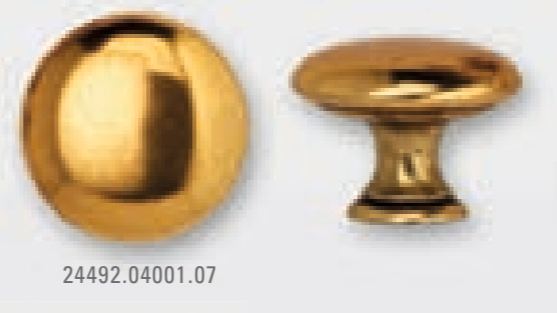
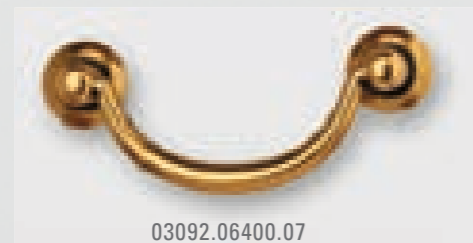
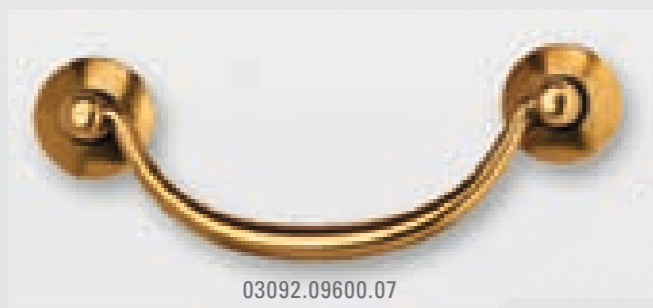

Finitura / Finish: 07 - Oro di Valenza

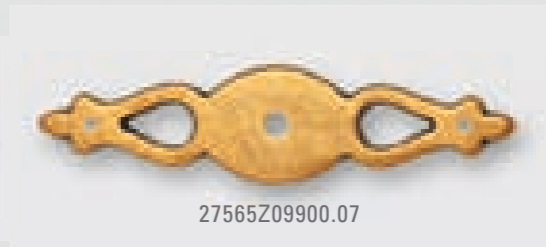
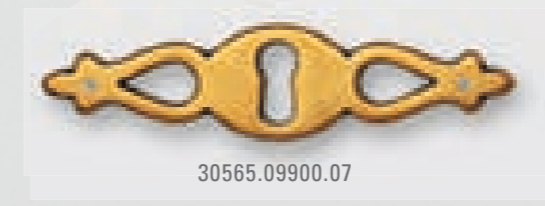
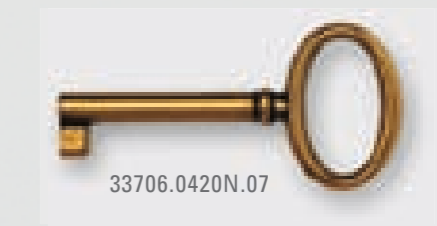
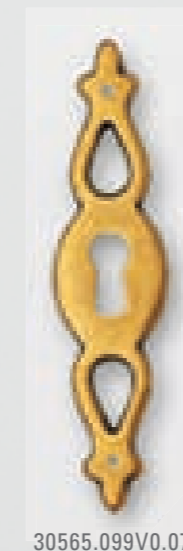

CODICE Code	MISURE Overall size	INTERASSE C.to C.
03092.09600	120x44	96
03092.06400	81x32	64
24492.04001	40x30	Ø 40
24492.03501	35x28	Ø 35
24492.03001	30x24	Ø 30
24492.02501	25x21	Ø 25

CODICE Code	MISURE Overall size	INTERASSE C.to C.
21396.05300	18x63	-
30565.099V0	24x99	-
30565.09900	99x24	-
33706.0240N	34x53	N 24
33706.0340N	34x63	N 34
33706.0380N	34x67	N 38

CODICE Code	MISURE Overall size	INTERASSE C.to C.
33706.0420N	34x71	N 42
33706.0530N	34x82	N 53
27565Z09900	99x24	-

Regency

Serie realizzabile in tutte le finiture indicate a catalogo / Series available in all finishes in the catalogue.

Regency

Serie realizzabile in tutte le finiture indicate a catalogo / Series available in all finishes in the catalogue.

Finitura / Finish: 03 - Ottone antico / Antique brass

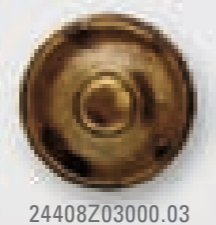
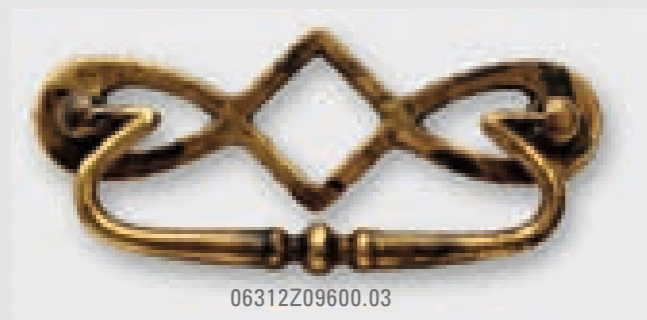

Finitura / Finish: 03 - Ottone antico / Antique brass

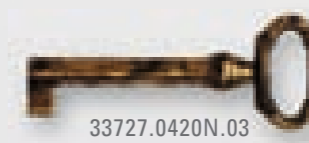
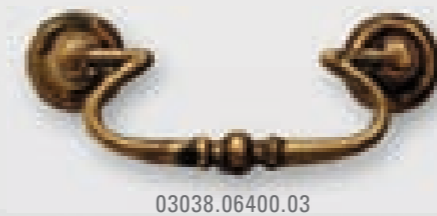
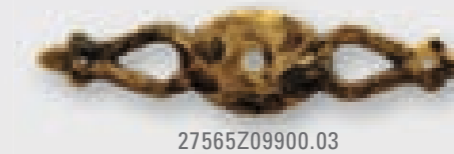
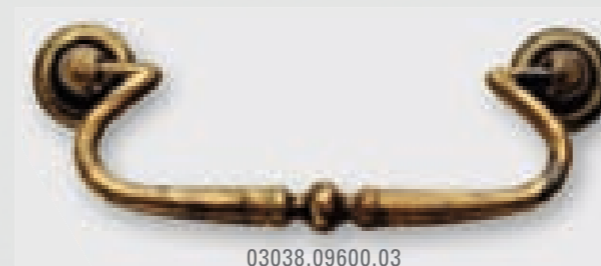

CODICE Code	MISURE Overall size	INTERASSE C.to C.
06312Z09600	116x51	96
21395Z04900	20x59	-
24408Z03500	35x30	Ø 35
24408Z03000	30x26	Ø 30
24408Z02500	25x23	Ø 25

CODICE Code	MISURE Overall size	INTERASSE C.to C.
03038.09600	117x44	96
03038.06400	85x38	64
30565.099V0	24x99	-
30565.09900	99x24	-
33727.0420N	27x69	N 42
33727.0340N	27x61	N 34

CODICE Code	MISURE Overall size	INTERASSE C.to C.
33727.0240N	27x51	N 24
27565Z09900	99x24	-

Regency

Serie realizzabile in tutte le finiture indicate a catalogo / Series available in all finishes in the catalogue.

Regency

Serie realizzabile in tutte le finiture indicate a catalogo / Series available in all finishes in the catalogue.

Finitura / Finish: 54 - Patinè bm

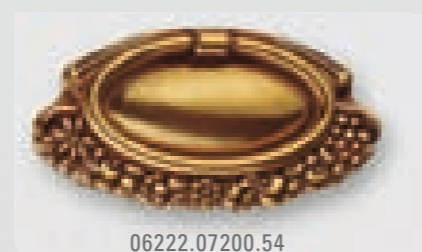
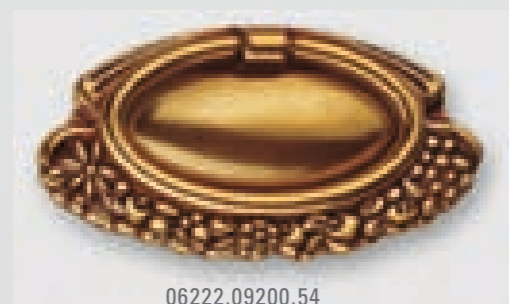

Finitura / Finish: 54 - Patinè bm

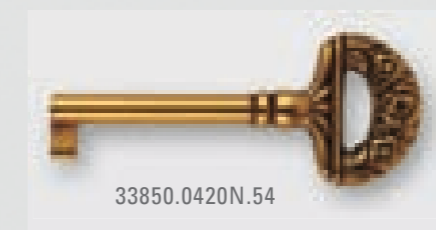

CODICE Code	MISURE Overall size	INTERASSE C.to C.
03850.09600	122x67	96
03850.06400	83x55	64
06222.09200	92x49	32
06222.07200	72x38	32

CODICE Code	MISURE Overall size	INTERASSE C.to C.
21850.05700	22x68	-
24850Z03000	30x26	Ø 30
24850Z02500	25x23	Ø 25
30850.038V0	25x38	-
33850.0420N	31x76	N 42
33850.0340N	31x68	N 34

Regency

Serie realizzabile in tutte le finiture indicate a catalogo / Series available in all finishes in the catalogue.

Rustico

Serie realizzabile in tutte le finiture indicate a catalogo / Series available in all finishes in the catalogue.

Finitura / Finish: 07 - Oro di Valenza

Finitura / Finish: 03 - Ottone antico / Antique brass



03025.09600.07

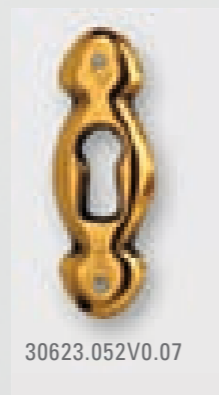

30623.052V0.07

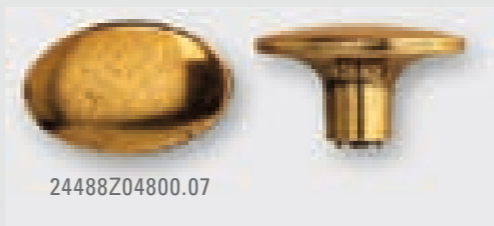

24488Z04800.07



24488Z03700.07



24488Z03000.07

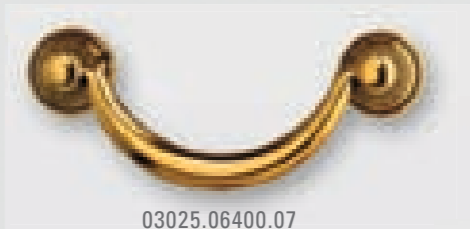

03025.06400.07



33712.0240N.07

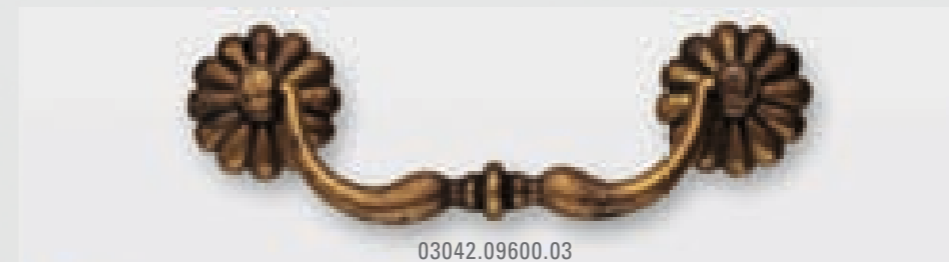

03042.09600.03

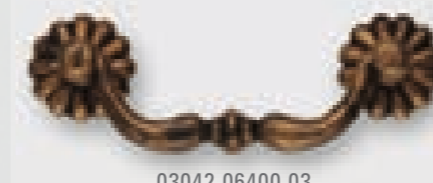

03042.06400.03



30682.058V0.03

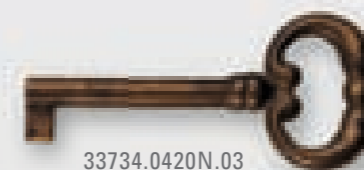

33734.0420N.03



24499.04001.03



24499Z03500.03



24499Z03000.03



24499Z02500.03

CODICE
Code

MISURE
Overall size

INTERASSE
C.to C.

CODICE
Code

MISURE
Overall size

INTERASSE
C.to C.

CODICE
Code

MISURE
Overall size

INTERASSE
C.to C.

CODICE
Code

MISURE
Overall size

INTERASSE
C.to C.

03025.09600
03025.06400
24488Z04800
24488Z03700
24488Z03000
30623.052V0

117x49
79x33
48x30x24
37x23x21
30x19x19
17x52

96
64
-
-
-
-

33712.0420N
33712.0340N
33712.0240N

20x75
20x67
20x57

N 42
N 34
N 24

03042.09600
03042.06400
24499.04001
24499Z03500
24499Z03000
24499Z02500

127x43
84x28
40x34
35x28
30x24
25x21

96
64
Ø 40
Ø 35
Ø 30
Ø 25

30682.058V0
33734.0530N
33734.0420N
33734.0340N

38x58
32x83
32x72
32x64

-
N 53
N 42
N 34

Rustico

Serie realizzabile in tutte le finiture indicate a catalogo / Series available in all finishes in the catalogue.

C.378

Stile

Finitura / Finish: 03 - Ottone antico / Antique brass



Rustico

Serie realizzabile in tutte le finiture indicate a catalogo / Series available in all finishes in the catalogue.

C.379

Stile

Finitura / Finish: 03 - Ottone antico / Antique brass



CODICE Code	MISURE Overall size	INTERASSE C.to C.
06888.06400	115x49	64
12887.11500	40x115	-
12887.11501	40x115	-
12888.11500	115x55	-
15138.08000	26x80	-
33700.0420N	35x84	42 

CODICE Code	MISURE Overall size	INTERASSE C.to C.
25888.11500	115x38	-
27888.11500	115x38	-
30888.115V0	38x115	-
30888.11500	115x38	-

Rustico

Serie realizzabile in tutte le finiture indicate a catalogo / Series available in all finishes in the catalogue.

Rustico

Serie realizzabile in tutte le finiture indicate a catalogo / Series available in all finishes in the catalogue.

Finitura / Finish: 03 - Ottone antico / Antique brass

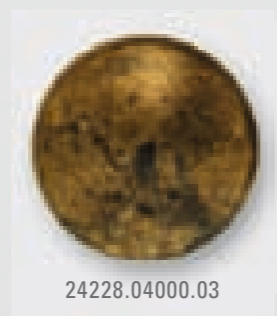

24228.04000.03



24228.03600.03



24228.03200.03

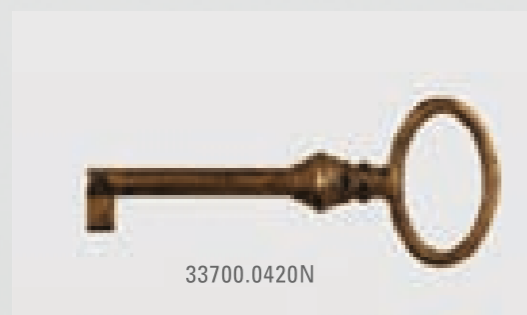

33700.0420N

Finitura / Finish: 03 - Ottone antico / Antique brass



24228.03000.03

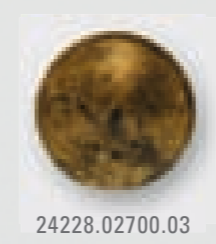

24228.02700.03

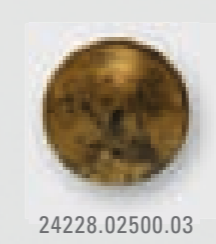

24228.02500.03

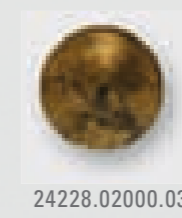

24228.02000.03

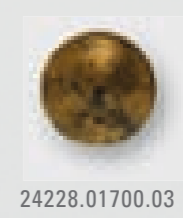

24228.01700.03

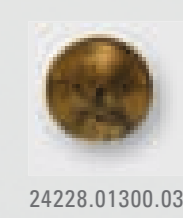

24228.01300.03



09208.05000.03



09208.04000.03



09208.03300.03

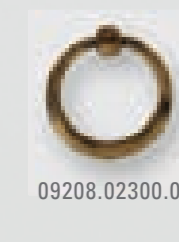

09208.02300.03

CODICE Code	MISURE Overall size	INTERASSE C.to C.
24228.04000	40x37	Ø 40
24228.03600	36x29	Ø 36
24228.03200	32x25	Ø 32
24228.03000	30x24	Ø 30
24228.02700	27x23	Ø 27
24228.02500	25x22	Ø 25

CODICE Code	MISURE Overall size	INTERASSE C.to C.
24228.02000	20x18	Ø 20
24228.01700	17x15	Ø 17
24228.01300	13x13	Ø 13
33700.0420N	35x84	N 42
33700.0340N	35x76	N 34

CODICE Code	MISURE Overall size	INTERASSE C.to C.
09208.05000	50x52	-
09208.04000	40x42	-
09208.03300	33x36	-
09208.02300	23x25	-

Rustico

Serie realizzabile in tutte le finiture indicate a catalogo / Series available in all finishes in the catalogue.

C.382

Stile

Finitura / Finish: 09 - Florence

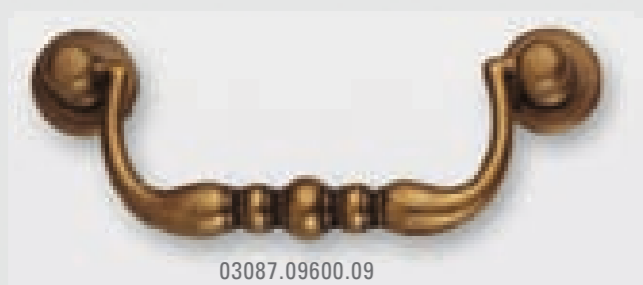

03087.09600.09



09207.06700.09



24487Z03500.09



03087.06400.09

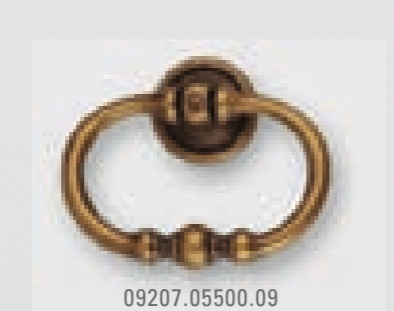

09207.05500.09

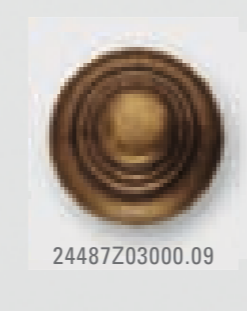

24487Z03000.09



21397.05700.09



30630.057V0.09

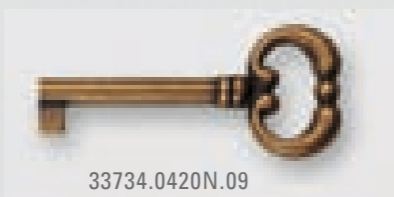

33734.0420N.09

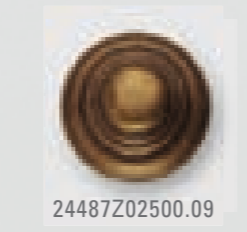

24487Z02500.09

Rustico

Serie realizzabile in tutte le finiture indicate a catalogo / Series available in all finishes in the catalogue.

C.383

Stile

Finitura / Finish: 09 - Florence



03075Z10000.09



24496Z03500.09



03075Z08400.09

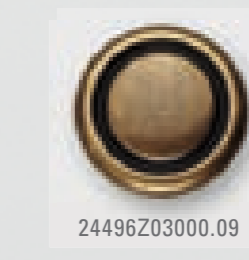

24496Z03000.09



21397.05700.09



30693.047V0.09

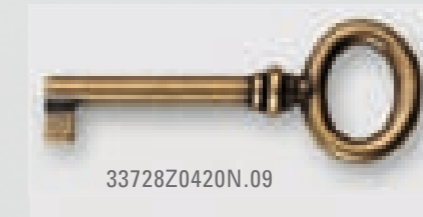

33728Z0420N.09

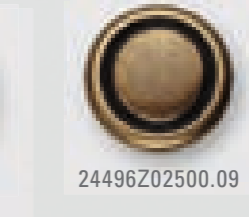

24496Z02500.09

CODICE Code	MISURE Overall size	INTERASSE C.to C.	CODICE Code	MISURE Overall size	INTERASSE C.to C.	CODICE Code	MISURE Overall size	INTERASSE C.to C.	CODICE Code	MISURE Overall size	INTERASSE C.to C.
03087.09600	116x46	96	24487Z03000	30x27	Ø 30	03075Z10000	128x55	100	30693.047V0	24x47	-
03087.06400	82x32	64	24487Z02500	25x25	Ø 25	03075Z08400	106x44	84	33728Z0530N	29x88	N 53
09207.06700	67x53	-	30630.057V0	20x57	-	21397.05700	22x68	-	33728Z0420N	29x77	N 42
09207.05500	55x45	-	33734.0530N	32x83	N 53	24496Z03500	35x26	35	33728Z0340N	29x69	N 34
21397.05700	22x68	-	33734.0420N	32x72	N 42	24496Z03000	30x24	30			
24487Z03500	35x31	Ø 35	33734.0340N	32x64	N 34	24496Z02500	25x21	25			

Marina

Serie realizzabile in tutte le finiture indicate a catalogo / Series available in all finishes in the catalogue.

C.384

Stile

Finitura / Finish: 11 - Ottone lucido / Polished brass



06320.09100.11



06327.05700.11

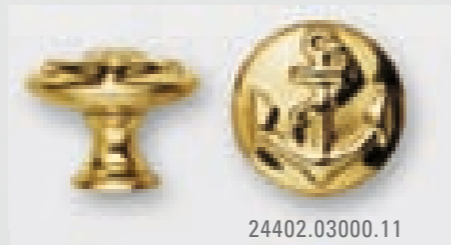

24402.03000.11



24402.02500.11



06320.07500.11



45948.05400.11



45949.05400.11



45947.05400.11

Marina

Serie realizzabile in tutte le finiture indicate a catalogo / Series available in all finishes in the catalogue.

C.385

Stile

Finitura / Finish: 11 - Ottone lucido / Polished brass



03006.09600.11



03007.09600.11



30618.023V0.11



33732.0420N.11

CODICE Code	MISURE Overall size	INTERASSE C.to C.
06320.09100	91x62	-
06320.07500	75x50	-
06327.05700	43x57	-
24402.03000	30x24	Ø 30
24402.02500	25x20	Ø 25

CODICE Code	MISURE Overall size	INTERASSE C.to C.
45947.05400	54x54x22	-
45948.05400	54x54x20	-
45949.05400	54x54x22	-

CODICE Code	MISURE Overall size	INTERASSE C.to C.
03006.09600	126x51	96
03007.09600	130x60	96
30618.023V0	13x23	-
33732.0420N	25x77	N 42
33732.0340N	25x69	N 34

Vittoriano

Serie realizzabile in tutte le finiture indicate a catalogo / Series available in all finishes in the catalogue.

Vittoriano

Serie realizzabile in tutte le finiture indicate a catalogo / Series available in all finishes in the catalogue.

Finitura / Finish: 09 - Firenze

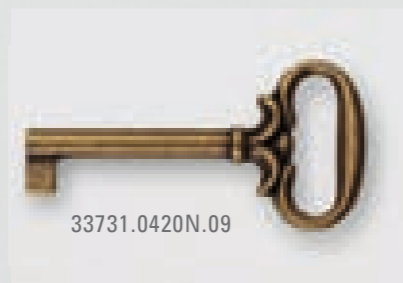
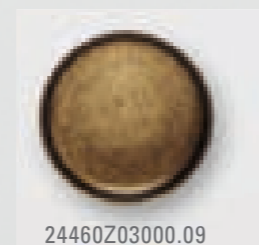
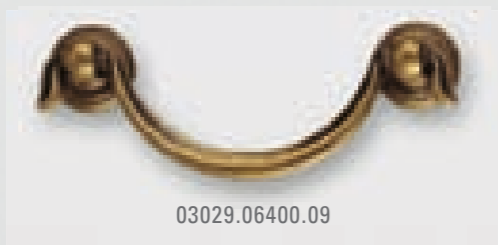
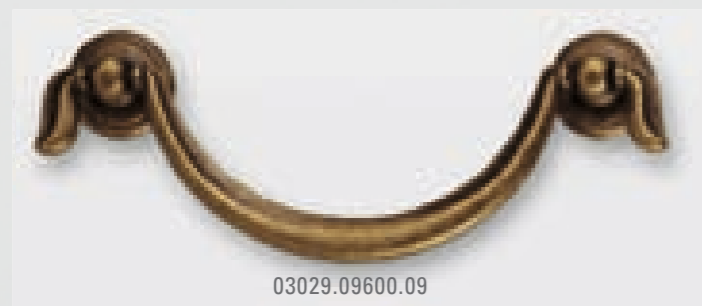

Finitura / Finish: 54 - Patinè bm



CODICE Code	MISURE Overall size	INTERASSE C.to C.
03029.09600	127x50	96
03029.06400	85x33	64
24460Z03500	35x24	Ø 35
24460Z03000	30x24	Ø 30
24460Z02500	25x20	Ø 25

CODICE Code	MISURE Overall size	INTERASSE C.to C.
30626.037V0	25x37	-
33731.0420N	35x69	N 42
33731.0340N	35x61	N 34

CODICE Code	MISURE Overall size	INTERASSE C.to C.
06215.06400	82x62	64
06215.04500	61x43	45
24216Z03000	29x20x20	-
30643.038V0	25x38	-
30643.03800	38x25	-

CODICE Code	MISURE Overall size	INTERASSE C.to C.
33217.0530N	32x80	N 53
33217.0420N	32x69	N 42
33217.0340N	32x61	N 34

Maniglie per vassoi / Tray handles

Serie realizzabile in tutte le finiture indicate a catalogo / Series available in all finishes in the catalogue.

Maniglie per vassoi / Tray handles

Serie realizzabile in tutte le finiture indicate a catalogo / Series available in all finishes in the catalogue.

Finitura / Finish: 32 - Nickel lucido / Bright nickel
09 - Firenze

Doppio sistema di fissaggio / Double fixing sistem

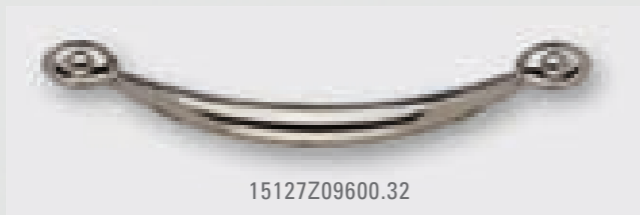

15127Z09600.32

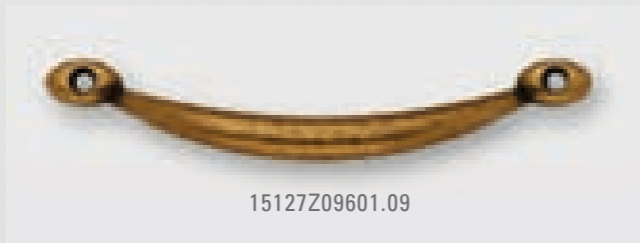

15127Z09601.09



Finitura / Finish: 11 - Ottone lucido / Polished brass
07 - Oro di Valenza

Doppio sistema di fissaggio / Double fixing sistem



15131Z09600.11



15131Z09601.07



CODICE Code	MISURE Overall size	INTERASSE C. to C.
15127Z09600	111x22	96
15127Z09601	112x35	96 per vassoi / for tray

CODICE Code	MISURE Overall size	INTERASSE C. to C.
15131Z09600	112x35	96
tray15131Z09601	112x35	96 per vassoi / for tray

Finitura / Finish: 27 - Ferro vecchio / Old iron



Finitura / Finish: 27 - Ferro vecchio / Old iron



CODICE Code	MISURE Overall size	INTERASSE C.to C.
06999.06400	127x50	64
12999.11500	115x50	-
25999.11500	115x38	-
27999.11500	115x38	-
30999.11500	115x38	-
33004.0400N	26x70	N 40 

CODICE Code	MISURE Overall size	INTERASSE C.to C.
12998.11500	37x115	-
12998.11501	37x115	-
30999.115V0	38x115	-
39037.03000	60x110	30
39037.02500	50x110	25

CODICE Code	MISURE Overall size	INTERASSE C.to C.
39037.02000	40x110	20
39037.01500	30x110	15

Finitura / Finish: 27 - Ferro vecchio / Old iron

Finitura / Finish: 27 - Ferro vecchio / Old iron

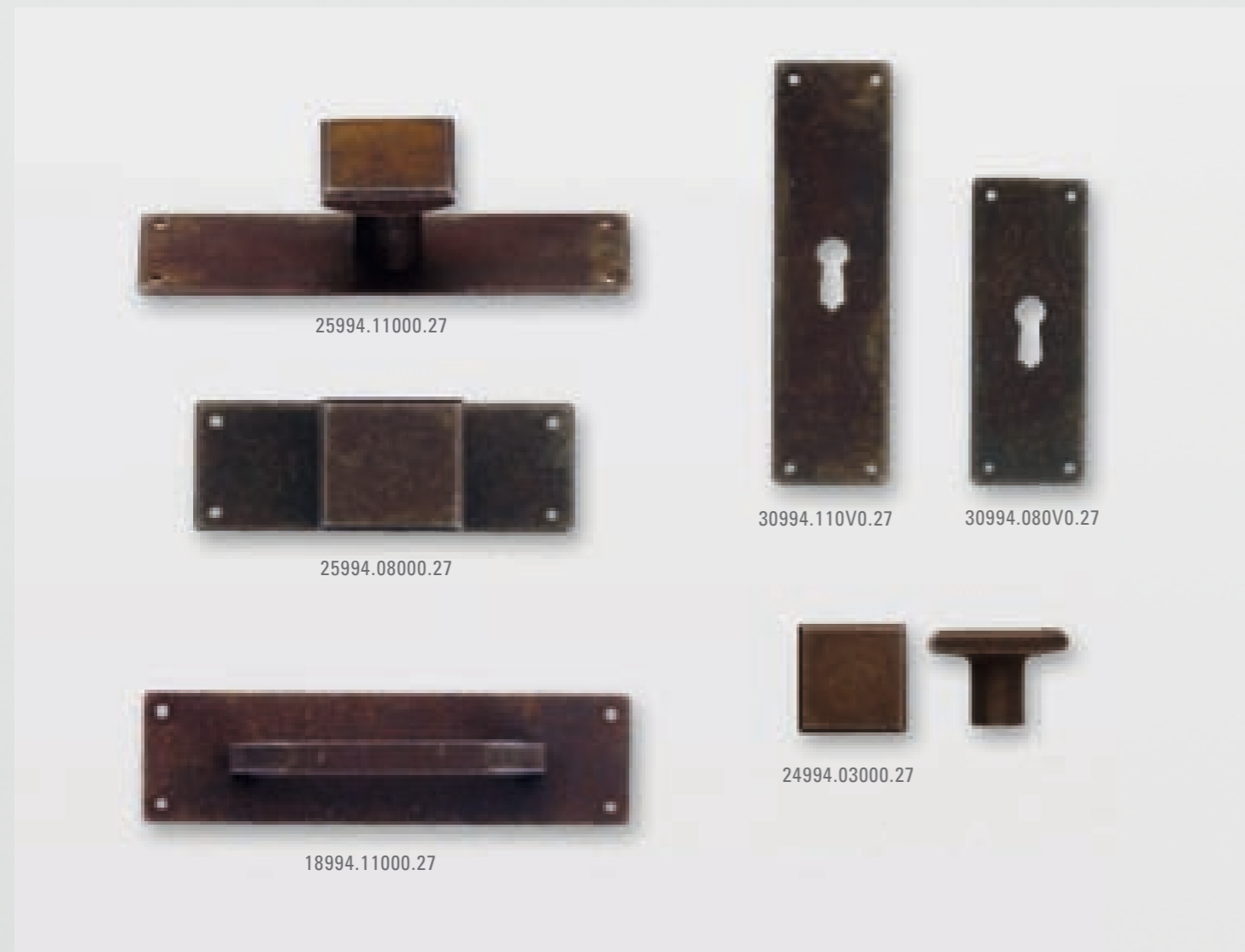

CODICE <i>Code</i>	MISURE <i>Overall size</i>	INTERASSE <i>C.to C.</i>
18994.11000	110x30	110
24994.03000	30x30x22	-
25994.11000	110x30	-
25994.08000	80x30	-
30994.080V0	30x80	-
30994.110V0	30x110	-

CODICE <i>Code</i>	MISURE <i>Overall size</i>	INTERASSE <i>C.to C.</i>
18994.12800	158x30	128
18994.09600	126x30	96
18994.06400	84x30	64
30994.08000	80x30	-
30994.11000	110x30	-

Finitura / Finish: 27 - Ferro vecchio / Old iron



Finitura / Finish: 27 - Ferro vecchio / Old iron



CODICE
Code

MISURE
Overall size

INTERASSE
C. to C.

CODICE
Code

MISURE
Overall size

INTERASSE
C. to C.

12997.11001
12997.08001
24999.03000
25996.11000
25996.08000

30x110
30x80
30x25
110x30
80x30

-
-
Ø 30
-
-

30995.03000
30996.110V0
30996.11000
30996.080V0
30996.08000

30x30
30x110
110x30
30x80
80x30

-
-
-
-
-

CODICE
Code

MISURE
Overall size

INTERASSE
C. to C.

CODICE
Code

MISURE
Overall size

INTERASSE
C. to C.

03995.06400
06996.06400
12995.05000
12996.08000
12996.11000

95x43
110x43
37x50
80x42
110x42

64
64
-
-
-

12997.11000
12997.08000

30x110
30x80

-
-

Ferro / Iron

Serie realizzabile in tutte le finiture indicate a catalogo / Series available in all finishes in the catalogue.

C.396

Stile

Finitura / Finish: 27 - Ferro vecchio / Old Iron

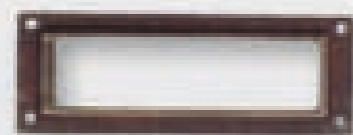

45123.08000.27



15122.09600.27



15123.08000.27



15122.07700.27



15139.08000.27

CODICE <i>Code</i>	MISURE <i>Overall size</i>	INTERASSE <i>C.to C.</i>
15122.09600	96x37	-
15122.07700	77x31	-
15123.08000	80x50	-
15139.08000	26x80	-
45123.08000	80x29	-

Indice collezioni / Index collections

Cosmopolitan
Grace
New Dèco
Classic

PAG. 398
PAG. 412
PAG. 422
PAG. 443



Ceramica

**POSSIBILITÀ DI CONFIGURAZIONI AD
HOC PER METALLO E DECORO**
**POSSIBILITY TO MATCH DIFFERENT
FINISHES AND DECORATIONS.**

Cosmopolitan

DESIGN: MARELLA DESIGN LAB

Serie realizzabile in tutte le finiture indicate a catalogo / Series available in all finishes in the catalogue.

C.401

Ceramica / Ceramic: Bianca lucida / Bright white
Finitura / Finish: 36 - Cromo lucido / Bright chrome



CODICE

Code

15178P1281A.36

24178P0691A.36

MISURE

Overall size

144x27x32

69x25x27

INTERASSE

C. to C.

128

-

Ceramica / Ceramic: Bianca lucida / Bright white

Finitura / Finish: 36 - Cromo lucido / Bright chrome

CODICE

Code

15178P128BA.36

24178P069BA.36

MISURE

Overall size

144x27x32

69x25x27

INTERASSE

C. to C.

128

-

Ceramica / Ceramic: Nera lucida / Bright black

Finitura / Finish: 36 - Cromo lucido / Finitura / Finish:

Bright chrome



Cosmopolitan

DESIGN: MARELLA DESIGN LAB

Serie realizzabile in tutte le finiture indicate a catalogo / Series available in all finishes in the catalogue.

Ceramica / Ceramic: Nera lucida decoro chester oro/Bright black deco chester gold
Finitura / Finish: 07 - Oro di Valenza



15178P128B4.07

24178P069B4.07

Cosmopolitan

DESIGN: MARELLA DESIGN LAB

Serie realizzabile in tutte le finiture indicate a catalogo / Series available in all finishes in the catalogue.

Ceramica / Ceramic: Panna decoro chester oro / Cream deco chester gold
Finitura / Finish: 07 - Oro di Valenza



15178P12824.07

24178P06924.07

CODICE <i>Code</i>	MISURE <i>Overall size</i>	INTERASSE <i>C. to C.</i>
15178P128B4.07	144x27x32	128
24178P069B4.07	69x25x27	-

CODICE <i>Code</i>	MISURE <i>Overall size</i>	INTERASSE <i>C. to C.</i>
15178P12824.07	144x27x32	128
24178P06924.07	69x25x27	-

Cosmopolitan

DESIGN: MARELLA DESIGN LAB

Serie realizzabile in tutte le finiture indicate a catalogo / Series available in all finishes in the catalogue.

Ceramica / Ceramic: Panna decoro oro baroque / Cream deco baroque gold
Finitura / Finish: 07 - Oro di Valenza



15178P12823.07



24178P06923.07



Finitura / Finish: 07 - Oro di Valenza

CODICE

Code

15178P12823.07

24178P06923.07

MISURE

Overall size

144x27x32

69x25x27

INTERASSE

C. to C.

128

-

Cosmopolitan

DESIGN: MARELLA DESIGN LAB

Serie realizzabile in tutte le finiture indicate a catalogo / Series available in all finishes in the catalogue.

C.409

Ceramica / Ceramic: Tortora decoro blossom grigio / Tortora deco blossom gray
Finitura / Finish: 36 - Cromo lucido / Bright chrome

Ceramica



15178P128F7.36



24178P069F7.36

CODICE <i>Code</i>	MISURE <i>Overall size</i>	INTERASSE <i>C. to C.</i>
15178P128F7.36	144x27x32	128
24178P069F7.36	69x25x27	-

Cosmopolitan

DESIGN: MARELLA DESIGN LAB

Serie realizzabile in tutte le finiture indicate a catalogo / Series available in all finishes in the catalogue.

Ceramica / Ceramic: Bianca decoro vintage grigio / White deco vintage grey
Finitura / Finish: 25 - Argento vecchio / Old silver



15178P12815.25

24178P06915.25

Cosmopolitan

DESIGN: MARELLA DESIGN LAB

Serie realizzabile in tutte le finiture indicate a catalogo / Series available in all finishes in the catalogue.

Ceramica / Ceramic: Blu decoro Vintage Poland / Blu deco Vintage Poland
Finitura / Finish: 36 - Cromo lucido / Bright chrome



15178P12886.36

24178P06986.36

CODICE <i>Code</i>	MISURE <i>Overall size</i>	INTERASSE <i>C. to C.</i>
15178P12815.25	144x27x32	128
24178P06915.25	69x25x27	-

CODICE <i>Code</i>	MISURE <i>Overall size</i>	INTERASSE <i>C. to C.</i>
15178P12886.36	144x27x32	128
24178P06986.36	69x25x27	-

Finitura / Finish: 25 - Argento Vecchio/ Old silver



Finitura / Finish: 36 - Cromo lucido / Bright chrome



C.413

Ceramica

Grace

DESIGN: MARELLA DESIGN LAB

Serie realizzabile in tutte le finiture indicate a catalogo / Series available in all finishes in the catalogue.

C.415

Ceramica / Ceramic: Bianca lucida / Bright white
Finitura / Finish: 32- Nickel lucido / Bright nickel

Ceramica



15176P1281A.32



24176P0581A.32



24316P0351A.32

CODICE <i>Code</i>	MISURE <i>Overall size</i>	INTERASSE <i>C. to C.</i>
15176P1281A.32	161x32x34	128
24176P0581A.32	58x32x29	-
24316P0351A.32	34x29	Ø 35



Ceramica / Ceramic: Panna / Cream
Finitura / Finish: 07- Oro di Valenza / Oro di Valenza



Ceramica / Ceramic: Nero lucido / Bright black
Finitura / Finish: 32- Nickel lucido / Bright nickel



Ceramica / Ceramic: Panna / Cream
Finitura / Finish: 46- Oro opaco / Mat gold



Ceramica / Ceramic: Panna / Cream
Finitura / Finish: 47- Argento orientale / Oriental silver



**FINITURE E COMBINAZIONI DISPONIBILI
SULLA SERIE COMPLETA:
FINISHES AND COMBINATIONS AVAILABLE
ON THE COMPLETE RANGE:**

**CODICE
Code**

15176P1282A.07
24176P0582A.07
24316P0352A.07

**CODICE
Code**

15176P128BA.32
24176P058BA.32
24316P035BA.32

**CODICE
Code**

15176P1282A.46
24176P0582A.46
24316P0352A.46

**CODICE
Code**

15176P1281A.47
24176P0581A.47
24316P0351A.47

Grace

DESIGN: MARELLA DESIGN LAB

Serie realizzabile in tutte le finiture indicate a catalogo / Series available in all finishes in the catalogue.

Ceramica / Ceramic: Nera - decoro carillon oro / Black - deco carillon gold
Finitura / Finish: 46- Oro opaco / Mat gold



15176P128EJ.46

24176P058EJ.46

24316P035EJ.46

Grace

DESIGN: MARELLA DESIGN LAB

Serie realizzabile in tutte le finiture indicate a catalogo / Series available in all finishes in the catalogue.

Ceramica / Ceramic: Panna - decoro armonia oro / Cream - deco armonia gold
Finitura / Finish: 07- Oro di Valenza



15176P12821.07

24176P05821.07

24316P03521.07

CODICE Code	MISURE Overall size	INTERASSE C.to C.
15176P128EJ.46	161x32x34	128
24176P058EJ.46	58x32x29	-
24316P035EJ.46	34x29	Ø 35

CODICE Code	MISURE Overall size	INTERASSE C.to C.
15176P12821.07	161x32x34	128
24176P05821.07	58x32x29	-
24316P03521.07	34x29	Ø 35

**FINITURE E COMBINAZIONI DISPONIBILI SULLA SERIE COMPLETA:
FINISHES AND COMBINATIONS AVAILABLE ON THE COMPLETE RANGE:**

Ceramica / Ceramic: Panna decoro carillon oro / Cream deco carillon gold
Finitura / Finish: 07- Oro di Valenza



decoro carillon
deco carillon

**CODICE
Code**

15176P1282J.07
24176P0582J.07
24316P0352J.07



decoro armonia
deco armonia

**CODICE
Code**

15176P12821.07
24176P05821.07
24316P03521.07



decoro carillon
deco carillon

**CODICE
Code**

15176P1281X.19
24176P0581X.19
24316P0351X.19



decoro armonia
deco armonia

**CODICE
Code**

15176P12812.19
24176P05812.19
24316P03512.19



decoro carillon
deco carillon

**CODICE
Code**

15176P1281X.32
24176P0581X.32
24316P0351X.32



decoro armonia
deco armonia

**CODICE
Code**

15176P12812.32
24176P05812.32
24316P03512.32

Ceramica / Ceramic: Bianca decoro carillon platino / White deco carillon platinum
Finitura / Finish: 19- Similferro / Similariron



Ceramica / Ceramic: Bianca decoro carillon platino / White deco carillon platinum
Finitura / Finish: 32- Nickel lucido / Bright nickel



**FINITURE E COMBINAZIONI DISPONIBILI SULLA SERIE COMPLETA:
FINISHES AND COMBINATIONS AVAILABLE ON THE COMPLETE RANGE:**

Ceramica / Ceramic: Nera opaca decoro carillon platino / Matt black deco carillon platinum
Finitura / Finish: 47- Argento orientale / Oriental silver



decoro carillon
deco carillon

**CODICE
Code**

15176P128EX.47
24176P058EX.47
24316P035EX.47



decoro armonia
deco armonia

**CODICE
Code**

15176P128E2.47
24176P058E2.47
24316P035E2.47



decoro carillon
deco carillon

**CODICE
Code**

15176P1282J.46
24176P0582J.46
24316P0352J.46



decoro armonia
deco armonia

**CODICE
Code**

15176P12821.46
24176P05821.46
24316P03521.46



decoro carillon
deco carillon

**CODICE
Code**

15176P128EJ.46
24176P058EJ.46
24316P035EJ.46



decoro armonia
deco armonia

**CODICE
Code**

15176P128E1.46
24176P058E1.46
24316P035E1.46

Ceramica / Ceramic: Panna decoro carillon oro / Cream deco carillon gold
Finitura / Finish: 46- Oro opaco / Mat gold



Ceramica / Ceramic: Nero opaco decoro carillon oro / Matt black deco carillon gold
Finitura / Finish: 46- Oro opaco / Mat gold





New Dèco

DESIGN: MARELLA DESIGN LAB

Serie realizzabile in tutte le finiture indicate a catalogo / Series available in all finishes in the catalogue.

C.425

Ceramica



Ceramica / Ceramic: Nero lucido / Bright black
Finitura / Finish: 32- Nickel lucido / Bright Nickel



15141P096BA.32

24316P035BA.32

Ceramica / Ceramic: Rosso opaco / Mat Red
Finitura / Finish: 19- Similferro / Simil iron



15141P096DA.19

24316P035DA.19

Ceramica / Ceramic: Nero opaco / Mat black
Finitura / Finish: 32- Nickel lucido / Bright Nickel



15141P096EA.32

24316P035EA.32

CODICE <i>Code</i>	MISURE <i>Overall size</i>	INTERASSE <i>C.to C.</i>
15141P096BA.32	112x18	96
24316P035BA.32	34x29	Ø 35
15141P096DA.19	112x18	96
24316P035DA.19	34x29	Ø 35
15141P096EA.32	112x18	96
24316P035EA.32	34x29	Ø 35

New Dèco

DESIGN: MARELLA DESIGN LAB

Serie realizzabile in tutte le finiture indicate a catalogo / Series available in all finishes in the catalogue.

C.427



Ceramica / Ceramic: Nero opaco-decoro platino / Mat black-platinum deco
Finitura / Finish: 25- Argento vecchio / Old silver



15141P096ES.25

24316P035ES.25

Ceramica / Ceramic: Nero lucido-decoro platino / Bright black-platinum deco
Finitura / Finish: 32- Nickel lucido / Bright Nickel



15141P096BS.32

24316P035BS.32

Ceramica / Ceramic: Nero opaco-decoro platino / Mat black-platinum deco
Finitura / Finish: 47- Argento orientale / Oriental silver



15141P096ES.47

24316P035ES.47

CODICE <i>Code</i>	MISURE <i>Overall size</i>	INTERASSE <i>C.to C.</i>
15141P096ES.25	112x18	96
24316P035ES.25	34x29	Ø 35
15141P096BS.32	112x18	96
24316P035BS.32	34x29	Ø 35
15141P096ES.47	112x18	96
24316P035ES.47	34x29	Ø 35

New Dèco

DESIGN: MARELLA DESIGN LAB

Serie realizzabile in tutte le finiture indicate a catalogo / Series available in all finishes in the catalogue.

C.428

Ceramica

Ceramica / Ceramic: Rosso opaco-decoro oro / Mat red-gold deco
Finitura / Finish: 46- Oro opaco / Mat gold



15141P096DT.46

24316P035DT.46

Ceramica / Ceramic: Nero opaco-decoro oro / Mat black-gold deco
Finitura / Finish: 07- Oro di Valenza



15141P096ET.07

24316P035ET.07

New Dèco

DESIGN: MARELLA DESIGN LAB

Serie realizzabile in tutte le finiture indicate a catalogo / Series available in all finishes in the catalogue.

C.429

Ceramica

Ceramica / Ceramic: Effetto pietra / Stone effect
Finitura / Finish: 09- Florence



15141P096CA.09

24316P035CA.09

Ceramica / Ceramic: Effetto pietra / Stone effect
Finitura / Finish: 22- Old America



15141P096CA.22

24316P035CA.22

Ceramica / Ceramic: Rosso opaco-decoro oro / Mat red-gold deco
Finitura / Finish: 07- Oro di Valenza



15141P096DT.07

24316P035DT.07

CODICE Code	MISURE Overall size	INTERASSE C.to C.
15141P096DT.46	112x18	96
24316P035DT.46	34x29	Ø 35
15141P096ET.07	112x18	96
24316P035ET.07	34x29	Ø 35
15141P096DT.07	112x18	96
24316P035DT.07	34x29	Ø 35

CODICE Code	MISURE Overall size	INTERASSE C.to C.
15141P096CA.09	112x18	96
24316P035CA.09	34x29	Ø 35
15141P096CA.22	112x18	96
24316P035CA.22	34x29	Ø 35



New Dèco

DESIGN: MARELLA DESIGN LAB

Serie realizzabile in tutte le finiture indicate a catalogo / Series available in all finishes in the catalogue.

C.431

Ceramica

Ceramica / Ceramic: Nero lucido / Bright black
Finitura / Finish: 83- Graphite



Ceramica / Ceramic: Panna / Cream
Finitura / Finish: 83- Graphite



Ceramica / Ceramic: Panna / Cream
Finitura / Finish: 82- Kassite



CODICE <i>Code</i>	MISURE <i>Overall size</i>	INTERASSE <i>C.to C.</i>
15136P128BA.83	146x24	128
24316P040BA.83	39x33	Ø 40
15136P096BA.83	112x22	96
24316P035BA.83	34x29	Ø 35
15136P1282A.83	146x24	128
24316P0402A.83	39x33	Ø 40
15136P0962A.83	112x22	96
24316P0352A.83	34x29	Ø 35
15136P1282A.82	146x24	128
24316P0402A.82	39x33	Ø 40
15136P0962A.82	112x22	96
24316P0352A.82	34x29	Ø 35

Finitura / Finish: 32 - Nickel lucido / Bright nickel

New Dèco

DESIGN: MARELLA DESIGN LAB

Serie realizzabile in tutte le finiture indicate a catalogo / Series available in all finishes in the catalogue.

C.433

Ceramica / Ceramic: Panna / Cream
Finitura / Finish: 32- Nickel lucido / Bright Nickel



Ceramica / Ceramic: Bianco / White
Finitura / Finish: 32- Nickel lucido / Bright Nickel



Ceramica

CODICE <i>Code</i>	MISURE <i>Overall size</i>	INTERASSE <i>C. to C.</i>
15136P1282A.32	146x24	128
24316P0402A.32	39x33	Ø 40
15136P0962A.32	112x22	96
24316P0352A.32	34x29	Ø 35
15136P1281A.32	146x24	128
24316P0401A.32	39x33	Ø 40
15136P0961A.32	112x22	96
24316P0351A.32	34x29	Ø 35

New Dèco

DESIGN: MARELLA DESIGN LAB

Serie realizzabile in tutte le finiture indicate a catalogo / Series available in all finishes in the catalogue.

C.435

Ceramica / Ceramic: Nero opaco / Mat black
Finitura / Finish: 32- Nickel lucido / Bright Nickel



Ceramica / Ceramic: Nero lucido / Bright black
Finitura / Finish: 32- Nickel lucido / Bright Nickel



Ceramica

CODICE <i>Code</i>	MISURE <i>Overall size</i>	INTERASSE <i>C. to C.</i>
15136P128EA.32	146x24	128
24316P040EA.32	39x33	Ø 40
15136P096EA.32	112x22	96
24316P035EA.32	34x29	Ø 35
15136P128BA.32	146x24	128
24316P040BA.32	39x33	Ø 40
15136P096BA.32	112x22	96
24316P035BA.32	34x29	Ø 35



New Dèco

DESIGN: MARELLA DESIGN LAB

Serie realizzabile in tutte le finiture indicate a catalogo / Series available in all finishes in the catalogue.

C.437

Ceramica / Ceramic: Soft flower
Finitura / Finish: 76- Cor-ten



Ceramica / Ceramic: colorful flower
Finitura / Finish: 22- Old America



Ceramica / Ceramic: Platinum Flower
Finitura / Finish: 32- Nickel lucido / Bright Nickel



CODICE <i>Code</i>	MISURE <i>Overall size</i>	INTERASSE <i>C.to C.</i>
15136P128V.76	146x24	128
24316P040V.76	39x33	Ø 40
15136P096V.76	112x22	96
24316P035V.76	34x29	Ø 35
15136P128AU.22	146x24	128
24316P040AU.22	39x33	Ø 40
15136P096AU.22	112x22	96
24316P035AU.22	34x29	Ø 35
15136P128BZ.32	146x24	128
24316P040BZ.32	39x33	Ø 40
15136P096BZ.32	112x22	96
24316P035BZ.32	34x29	Ø 35

New Dèco

DESIGN: MARELLA DESIGN LAB

Serie realizzabile in tutte le finiture indicate a catalogo / Series available in all finishes in the catalogue.

Ceramica / Ceramic: Rosso opaco-decoro oro / Mat red-gold deco
Finitura / Finish: 46- Oro opaco / Mat gold



Ceramica / Ceramic: nero opaco-decoro oro / Mat black-gold deco
Finitura / Finish: 46- Oro opaco / Mat gold



New Dèco

DESIGN: MARELLA DESIGN LAB

Serie realizzabile in tutte le finiture indicate a catalogo / Series available in all finishes in the catalogue.

Ceramica / Ceramic: Nero lucido-decoro oro / Bright black-gold deco
Finitura / Finish: 46 - Oro opaco / Mat gold



Finitura / Finish: 46 - Oro Opaco / Mat gold

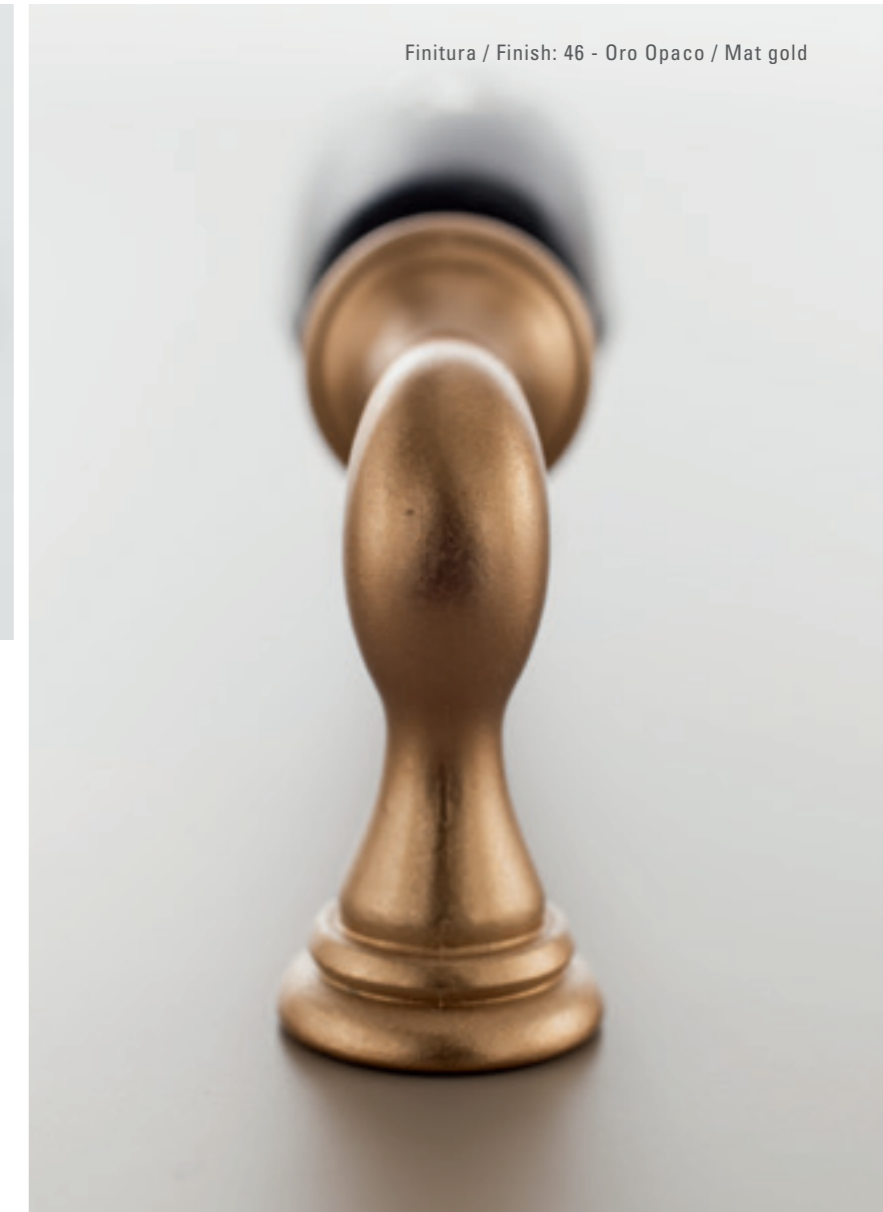

CODICE Code	MISURE Overall size	INTERASSE C. to C.
15136P128DT.46	146x24	128
24316P040DT.46	39x33	Ø 40
15136P096DT.46	112x22	96
24316P035DT.46	34x29	Ø 35
15136P128EW.46	146x24	128
24316P040EW.46	39x33	Ø 40
15136P096EW.46	112x22	96
24316P035EW.46	34x29	Ø 35

CODICE Code	MISURE Overall size	INTERASSE C. to C.
15136P128BW.46	146x24	128
24316P040BW.46	39x33	Ø 40
15136P096BW.46	112x22	96
24316P035BW.46	34x29	Ø 35

New Dèco

DESIGN: MARELLA DESIGN LAB

Serie realizzabile in tutte le finiture indicate a catalogo / Series available in all finishes in the catalogue.

Ceramica / Ceramic: Nero lucido-decoro oro / Bright black-gold deco
Finitura / Finish: 07- Oro di Valenza



Ceramica / Ceramic: Nero lucido-decoro oro / Bright black-gold deco
Finitura / Finish: 15- Bagno oro / Gold plated



Finitura / Finish: 15 - Bagno Oro/ Gold plated



CODICE Code	MISURE Overall size	INTERASSE C. to C.
15136P128BW.07	146x24	128
24316P040BW.07	39x33	Ø 40
15136P096BW.07	112x22	96
24316P035BW.07	34x29	Ø 35
15136P128BW.15	146x24	128
24316P040BW.15	39x33	Ø 40
15136P096BW.15	112x22	96
24316P035BW.15	34x29	Ø 35

New Dèco

DESIGN: MARELLA DESIGN LAB

Serie realizzabile in tutte le finiture indicate a catalogo / Series available in all finishes in the catalogue.

Ceramica / Ceramic: Nero opaco-decoro platino / Mat black-platinum deco
Finitura / Finish: 25- Argento vecchio / Old silver



Ceramica / Ceramic: Nero opaco-decoro platino / Mat black-platinum deco
Finitura / Finish: 47- Argento orientale / Oriental silver



New Dèco

DESIGN: MARELLA DESIGN LAB

Serie realizzabile in tutte le finiture indicate a catalogo / Series available in all finishes in the catalogue.

Ceramica / Ceramic: Effetto gress / Gress effect
Finitura / Finish: 19- Similferro / Similiron



Ceramica / Ceramic: Effetto pietra / Stone effect
Finitura / Finish: 76- Cor-ten



CODICE Code	MISURE Overall size	INTERASSE C. to C.
15136P128EY.25	146x24	128
24316P040EY.25	39x33	Ø 40
15136P096EY.25	112x22	96
24316P035EY.25	34x29	Ø 35
15136P128EY.47	146x24	128
24316P040EY.47	39x33	Ø 40
15136P096EY.47	112x22	96
24316P035EY.47	34x29	Ø 35

CODICE Code	MISURE Overall size	INTERASSE C. to C.
15136P128AA.19	146x24	128
24316P040AA.19	39x33	Ø 40
15136P096AA.19	112x22	96
24316P035AA.19	34x29	Ø 35
15136P128CA.76	146x24	128
24316P040CA.76	39x33	Ø 40
15136P096CA.76	112x22	96
24316P035CA.76	34x29	Ø 35

Simbologia / *Simbology*

Serie realizzabile in tutte le finiture indicate a catalogo / *Series available in all finishes in the catalogue.*

COMPOSIZIONE DEL CODICE ARTICOLO *ARTICLE CODE COMPOSITION*

Esempio / Example: 24136P0302B09

- 24 Codice Famiglia / Family code
- 136 Codice Modello / Model code
- P Materiale / Material
- 030 Diametro / Diameter - Interasse / CtoC
- 2 Colore ceramica / Ceramic code
- B Codice decoro / Decoration code
- 09 Finitura del metallo / Metal finish

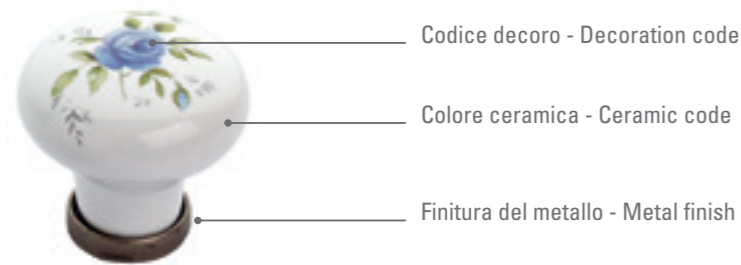

Ceramica / *Classic*

DESIGN: MARELLA DESIGN LAB

Serie realizzabile in tutte le finiture indicate a catalogo / *Series available in all finishes in the catalogue.*

Finitura / Finish: 19- Similferro / Similiron
1C Ceramica bianca / Ceramic white



CODICE <i>Code</i>	MISURE <i>Overall size</i>	INTERASSE <i>C. to C.</i>
15136P1281C.19	146x24	128
15136P0961C.19	112x22	96
24136P0301C.19	30x28	Ø 30
24136P0251C.19	25x24	Ø 25

Ceramica/Classic

DESIGN: MARELLA DESIGN LAB

Serie realizzabile in tutte le finiture indicate a catalogo / Series available in all finishes in the catalogue.

COMBINAZIONI DISPONIBILI: COMBINATION AVAILABLE:

Finitura / Finish: 1A.19 Bianco / White - Similferro / Similiron



Finitura / Finish: 1B.07 Panna / Cream - Oro di Valenza

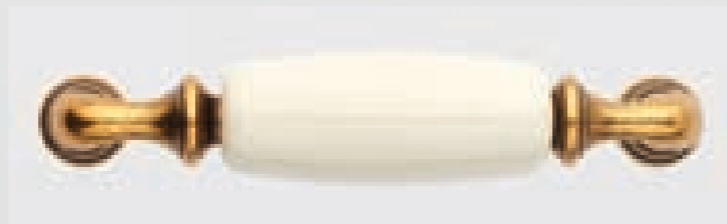

Ceramica/Classic

DESIGN: MARELLA DESIGN LAB

Serie realizzabile in tutte le finiture indicate a catalogo / Series available in all finishes in the catalogue.

COMBINAZIONI DISPONIBILI: COMBINATION AVAILABLE:

Finitura / Finish: 1B.09 Bianco / White - Florence



Finitura / Finish: 1C.09 Bianco / White - Florence



Finitura / Finish: 1A.09 Bianco / White - Florence



Finitura / Finish: 3A.09 Champagne - Florence



Finitura / Finish: 2B.09 Panna / Cream - Florence



Finitura / Finish: 3F.09 Champagne - Florence



Finitura / Finish: 2A.09 Panna / Cream - Florence



Finitura / Finish: 3A.19 Champagne - Similferro / Similiron



Finitura / Finish: 1C.32 Bianco / White - Nickel lucido / Bright Nickel



Ceramica/Classic

DESIGN: MARELLA DESIGN LAB

Serie realizzabile in tutte le finiture indicate a catalogo / *Series available in all finishes in the catalogue.*

COMBINAZIONI DISPONIBILI: COMBINATION AVAILABLE:

Finitura / Finish: 2A.22 Panna / Cream - Old America



Finitura / Finish: 2H.09 Panna / Cream - Florence



Ceramica/Classic

DESIGN: MARELLA DESIGN LAB

Serie realizzabile in tutte le finiture indicate a catalogo / *Series available in all finishes in the catalogue.*

Ceramica / Ceramic: Bianca / White
Finitura / Finish: 09 - Florence



15141P0961A.09



24136P0251A.09



24136P0301A.09

CODICE Code

15141P0961A.09
24136P0301A.09
24136P0251A.09

MISURE Overall size

112x18
30x28
25x24

INTERASSE C. to C.

96
Ø 30
Ø 25

Ceramica/Classic

DESIGN: MARELLA DESIGN LAB

Serie realizzabile in tutte le finiture indicate a catalogo / Series available in all finishes in the catalogue.

COMBINAZIONI DISPONIBILI: COMBINATION AVAILABLE:

Finitura / Finish: 1A.09 Bianco / White - Florence



Finitura / Finish: 2A.09 Panna / Cream - Florence



Ceramica/Classic

DESIGN: MARELLA DESIGN LAB

Serie realizzabile in tutte le finiture indicate a catalogo / Series available in all finishes in the catalogue.

COMBINAZIONI DISPONIBILI: COMBINATION AVAILABLE:

Finitura / Finish: 2F.09 Panna / Cream - Florence



Finitura / Finish: 3A.09 Champagne - Florence



Finitura / Finish: 1A.19 Bianco / White - Similferro / Similiron



Finitura / Finish: 2B.09 Panna / Cream - Florence



Finitura / Finish: 2G.09 Panna / Cream - Florence



Finitura / Finish: 3F.07 Champagne - Oro di Valenza



Finitura / Finish: 1H.07 Bianco / White - Oro di Valenza



Finitura / Finish: 2D.09 Panna / Cream - Florence



Finitura / Finish: 2H.09 Panna / Cream - Florence



Ceramica/Classic

DESIGN: MARELLA DESIGN LAB

Serie realizzabile in tutte le finiture indicate a catalogo / Series available in all finishes in the catalogue.

Finitura / Finish: 09 - Florence



03071P0962H.09



03071P0962A.09



15092Z0962D.09

CODICE <i>Code</i>	MISURE <i>Overall size</i>	INTERASSE <i>C. to C.</i>
03071P0962H.09	118x54	96
15092Z0962D.09	141x21x35	96

Indice collezioni / Index collections

<i>Crystals from Swarovski</i>	<i>PAG. 455</i>
<i>Madreperla/Mother of pearl</i>	<i>PAG. 488</i>
<i>Ambra/Amber</i>	<i>PAG. 496</i>
<i>Aurea</i>	<i>PAG. 502</i>

Élite

Collezione cristallo / Cristallo collection

Nel 2004, Roberto Marella, in partnership con uno dei più importanti attori dell'industria del mobile, ha dato il via all'abbinamento tra cristalli Swarovski e il metallo, creando e producendo una collezione di maniglie d'élite.

"Da precursori di maniglie con cristalli Swarovski siamo diventati i principali produttori, rigorosamente MADE IN ITALY. Le nostre collezioni hanno avuto, sin dall'inizio un notevole successo, tanto da essere diventate, oggi, le maniglie più vendute nel mondo."

Il rapporto con l'azienda Swarovski si è rafforzato; di anno in anno, tanto da portarci a sviluppare e a dare vita ad una collezione esclusiva ideata e disegnata da **Georg Seebacher**, un designer della rinomata casa austriaca.

Nelle maniglie Bosetti Marella la rielaborazione di linee classiche e vintage viene arricchita dalla brillante purezza e magia dei cristalli Swarovski.

Un connubio vincente e magico: l'eccellenza qualitativa di prodotti MADE IN ITALY, uniti alla preziosità, lucentezza e raffinatezza dei cristalli Swarovski, i più raffinati e di pregio presenti oggi sul mercato.

Maniglie e cristalli Swarovski: Una cascata di luce ed emozione, per oggetti del nostro vivere quotidiano.

In 2004, ROBERTO MARELLA S.p.A., in partnership with one of the most important players in the furniture industry, launched the combination between Crystals from Swarovski and the metal, creating and producing a collection of special end elite handles.

"From precursors handles with Crystals from Swarovski we have become the leading manufacturer, MADE IN ITALY. Our collections had immediately a great success, becoming today the bestselling handles in the world."

The relationship with the Swarovski Company, has strengthened year after year, enough to develop create with them an important and exclusive collection designed and created by a renowned designer of the Austrian Company: **Georg Seebacher**.

The Bosetti Marella handles focus on reworking of classic and vintage lines, enriching them with the brilliant purity and the magic of Crystals from Swarovski.

A winning dreamlike combination: The Quality and Excellence of MADE IN ITALY products, combined with the preciousness, brilliance and refinement of Crystals from Swarovski, the finest on the market today.

Bosetti Marella handles and Crystals from Swarovski: A waterfall of light and emotion for everyday life objects.



Glam

theme 01

“In questo concept la ricchezza estetica di cristalli Swarovski utilizzato per lampadari è stata reinterpretata; il cristallo è stato inserito in un nuovo contesto, dando vita ad un pomolo dall' eccellenza MADE IN ITALY , dalla forma unica ed inconfondibile e dal carattere estremamente elegante e glamour. La linea esterna e ornamentale del pomolo è stata studiata sulla forma stessa del pendeloque cristalli Swarovski, in modo che lo stesso e la magia dei suoi giochi di luce diventassero l' attrazione principale. Il cristallo viene catturato nella zona di presa per permettere di toccare con mano la sua forma, in modo tridimensionale. Magica brillantezza e unicità di cristalli Swarovski, unite all' eccellenza e qualità Marella Design.

Glam: Un magico, scintillante e lussuoso gioiello.

“By this concept, the esthetic richness of the cristalli Swarovski used fot chandelier, has been reinterpreted; the crystal has been included in a new context and the result is an excellent MADE IN ITALY knob, with unique and unmistakable shapes with a very elegant and glamorous character. The external form and ornamental knob is designed on the shapes of the pendeloque cristalli Swarovski , the crystal becomes the protagonist and the main attraction. It is caught in the grip area to allow the user to touch its shapes in three dimensions. Magic brilliance and uniqueness of the cristalli Swarovski, combined with the excellence and Quality of Marella Design products. GLAM: A magic, sparkling and opulent Jewel.

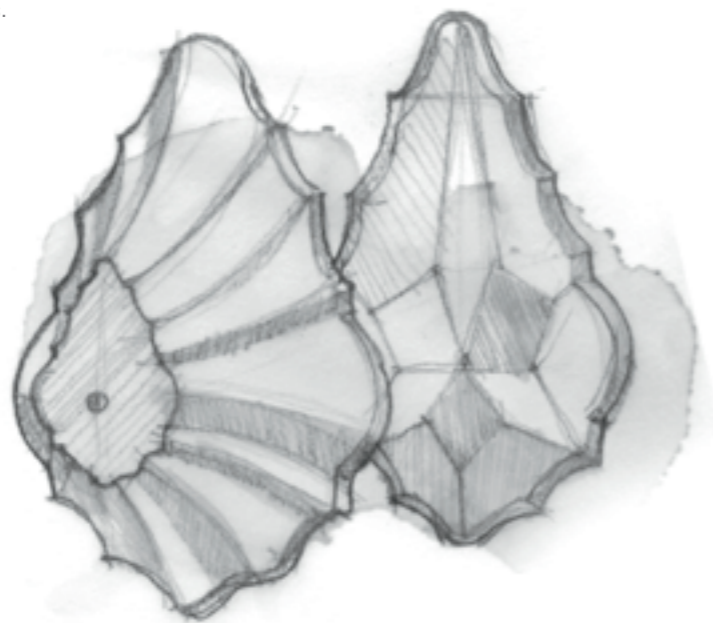

Glam

DESIGN: GEORG SEEBACHER

Serie realizzabile in tutte le finiture indicate a catalogo / *Series available in all finishes in the catalogue.*

Finitura / Finish: 15 - Bagno oro / Gold plated



24274Z06600.15



24274Z04200.15



Glam

DESIGN: GEORG SEEBACHER

Serie realizzabile in tutte le finiture indicate a catalogo / *Series available in all finishes in the catalogue.*

Finitura / Finish: 78 - Bagno Argento / Silver plated



24274Z06600.78



24274Z04200.78



CODICE <i>Code</i>	MISURE <i>Overall size</i>	INTERASSE <i>C. to C.</i>
24274Z06600	47x66x30	-
24274Z04200	30x42x24	-

CODICE <i>Code</i>	MISURE <i>Overall size</i>	INTERASSE <i>C. to C.</i>
24274Z06600	47x66x30	-
24274Z04200	30x42x24	-

Finitura / Finish: 36 - Cromo lucido / Bright chrome



Finitura / Finish: 78 - Bagno Argento / Silver plated



C.463

Elite

Finitura / Finish: 78 - Bagno Argento / Silver plated



Twist

COMBINAZIONI DISPONIBILI: COMBINATION AVAILABLE:



04 cristallo Swarovski Nero con finitura
N2 nero Opaco

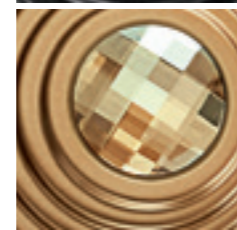

04 Crystals from Swarovski Black with finish
N2 - Mat black



05 cristallo Swarovski Golden Shadow con
finitura 46 Oro opaco

05 Crystals from Swarovski Golden shadow
with finish 46 Mat gold

00 cristallo Swarovski trasparente con
finiture: F5 Bianco Opaco/ 36 cromo lucido /
83 Graphite

00 Crystals from Swarovski Trasparent with
finishes: F5 Mat white / 36 Bright chrome /
83 Graphite

theme 02

"In questo concept, gli aspetti sensoriali e l'approccio di lasciare che ogni singolo pomolo sia slegato dal suo orientamento, sono le caratteristiche principali nello studio della serie Twist.

La stratificazione, la ripetizione di forme che si fondono e la libertà di montaggio hanno portato alla forma di un pomolo, che dà ai cristalli Swarovski una straordinaria inquadratura architettonica e scultorea. L'idea è nata dalla volontà di creare una forma in grado di elevare le superfici irregolari e che appare diversa, ogni qualvolta si cambia leggermente direzione di montaggio: Twist Unicità e imperfezione."

Nella collezione Twist, i cristalli Swarovski vengono proposti in tre differenti colorazioni: nero, abbinato al pomolo nero opaco dal carattere progressive e di tendenza; golden shadow abbinato al pomolo con finitura oro opaco per una versione più raffinata fashion, dalle tonalità brillanti; infine il cristallo Swarovski trasparente per magiche combinazioni e brillanti giochi di luce.

"The sensory aspects and the approach of letting each knob look individual by orientation, are the main features in the study of the Twist collection. The layering, repetition of shapes that blend and freedom of assembly led to the form of a knob, which gives the Crystals from Swarovski an extraordinary architectural and sculptural framing.

The idea was born from the desire to create a form that looks and seems to be different every time you change direction of mounting able to elevate the irregular surfaces: Uniqueness and imperfection."

The TWIST collection is presented with Crystals from Swarovski in three different colors: Black, combined with the knob in Matt black finish, a progressive and trendy version; golden shadow combined with the knob in gold finish for a more refined and fashion solution, with bright shades; finally the Crystals from Swarovski transparent for magic and brilliant version: exclusive and sparkling Made in Italy Knobs.

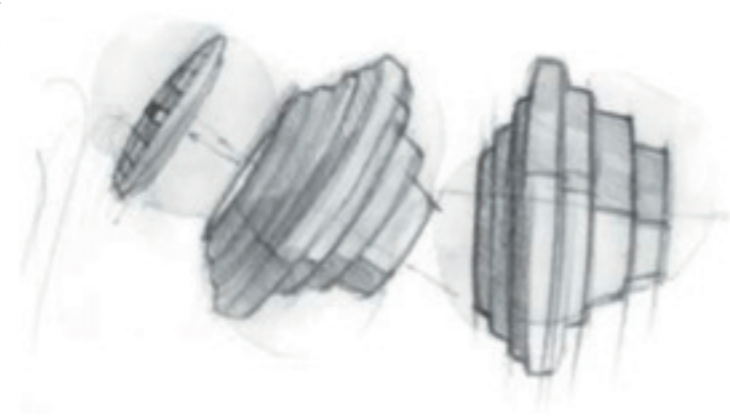

Twist

DESIGN: GEORG SEEBACHER

Serie realizzabile in tutte le finiture indicate a catalogo / Series available in all finishes in the catalogue.

F5 Bianco opaco / Mat white + 00 trasparente / Transparent Crystals from Swarovski



24273Z07200.F5



24273Z05200.F5



24273Z03200.F5



Twist

DESIGN: GEORG SEEBACHER

Serie realizzabile in tutte le finiture indicate a catalogo / Series available in all finishes in the catalogue.

46 Oro opaco / Mat gold + 05 Golden shadow Crystals from Swarovski



24273Z07205.46



24273Z05205.46



24273Z03205.46



CODICE <i>Code</i>	MISURE <i>Overall size</i>	INTERASSE <i>C. to C.</i>
24273Z07200.F5	72x36	Ø 72
24273Z05200.F5	52x33	Ø 52
24273Z03200.F5	32x26	Ø 32

CODICE <i>Code</i>	MISURE <i>Overall size</i>	INTERASSE <i>C. to C.</i>
24273Z07205.46	72x36	Ø 72
24273Z05205.46	52x33	Ø 52
24273Z03205.46	32x26	Ø 32

Twist

DESIGN: GEORG SEEBACHER

Serie eseguibile in tutte le finiture indicate a catalogo / Series available in all finishes in the catalogue.

C.469

N2 Nero opaco / Mat black + 04 Crystals from Swarovski



24273Z07204.N2



24273Z05204.N2



24273Z03204.N2



CODICE <i>Code</i>	MISURE <i>Overall size</i>	INTERASSE <i>C. to C.</i>
24273Z07204.N2	72x36	Ø 72
24273Z05204.N2	52x33	Ø 52
24273Z03204.N2	32x26	Ø 32



Finitura / Finish: 36 - Cromo lucido / Bright chrome



Finitura / Finish: 83 - Graphite



C.471

Elite



Cristallo trasparente disponibile con finiture /
Transparent crystal available with finishes:

- 36 - Cromo lucido / Bright chrome
- 83 - Graphite
- F5 - Bianco opaco / Mat white

Finitura / Finish: F5 - Bianco opaco / Mat white - RAL 9010



Trend natura

Finitura / Finish: 46 - Oro Opaco / Mat gold

C.472

C.473

theme 03

Introduction:

Jolie ed Amelie, eleganti maniglie impreziosite da cristalli Swarovski, caratterizzate da movimenti e geometrie semplici ma al contempo raffinate, in grado di celebrare linee e dettagli unici, presenti in natura. Amelie and Jolie, elegant and refined handles, embellished with Crystals from Swarovski, characterized by natural movements and geometries, at the same time refined, able to inspire unique details of nature.

Ispiration:

L'ispirazione nasce dal mondo della natura per imitarne le forme e creare oggetti di design molto affascinanti e di sicuro impatto emotivo. Questa collezione coglie l'essenza di morbidi ed eleganti movimenti naturali di foglie e fiori, trasformandoli in prodotti speciali; questa nuova gamma rappresenta un ottimo esempio di come la natura riesce ad ispirare particolari oggetti di design.

The inspiration comes from the natural world, the idea is to reproduce its forms creating objects having an attractive and emotional design.

This collection captures the essence of soft and elegant movements of natural leaves and flowers, turning them into special products; the ability of design makes the nature join special objects of design.

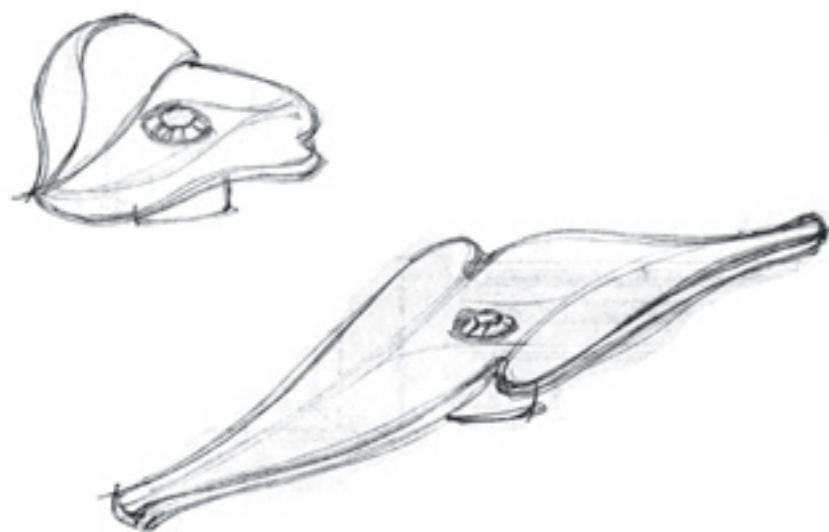

Elite

Amelie

DESIGN: MARELLA DESIGN LAB

Serie realizzabile in tutte le finiture indicate a catalogo / Series available in all finishes in the catalogue.

C.475

Finitura / Finish: 48 - Canna di fucile



15259Z17000.48



24259Z06000.48



24259Z03700.48



CODICE <i>Code</i>	MISURE <i>Overall size</i>	INTERASSE <i>C.to C.</i>
15259Z17000	170x48x23	-
24259Z06000	59x59x23	-
24259Z03700	37x36x20	-



Folie crystal

DESIGN: MARELLA DESIGN LAB

Serie realizzabile in tutte le finiture indicate a catalogo / Series available in all finishes in the catalogue.

Folie crystal

DESIGN: MARELLA DESIGN LAB

Serie realizzabile in tutte le finiture indicate a catalogo / Series available in all finishes in the catalogue.

Finitura / Finish: 32 - Nickel lucido / Bright Nickel

Finitura / Finish: 32 - Nickel lucido / Bright Nickel



CODICE Code	MISURE Overall size	INTERASSE C.to C.
15375Z128S1	160x83x29	128
15375Z096S1	123x65x25	96
24452Z03501	35x28	Ø 35
24452Z03001	30x26	Ø 30

CODICE Code	MISURE Overall size	INTERASSE C.to C.
15375Z128D1	160x83x29	128
15375Z096D1	123x65x25	96
24452Z03501	35x28	Ø 35
24452Z03001	30x26	Ø 30





15200

DESIGN: MARELLA DESIGN LAB

Serie realizzabile in tutte le finiture indicate a catalogo / Series available in all finishes in the catalogue.

C.481

Finitura / Finish: 32 - Nickel lucido / Bright Nickel

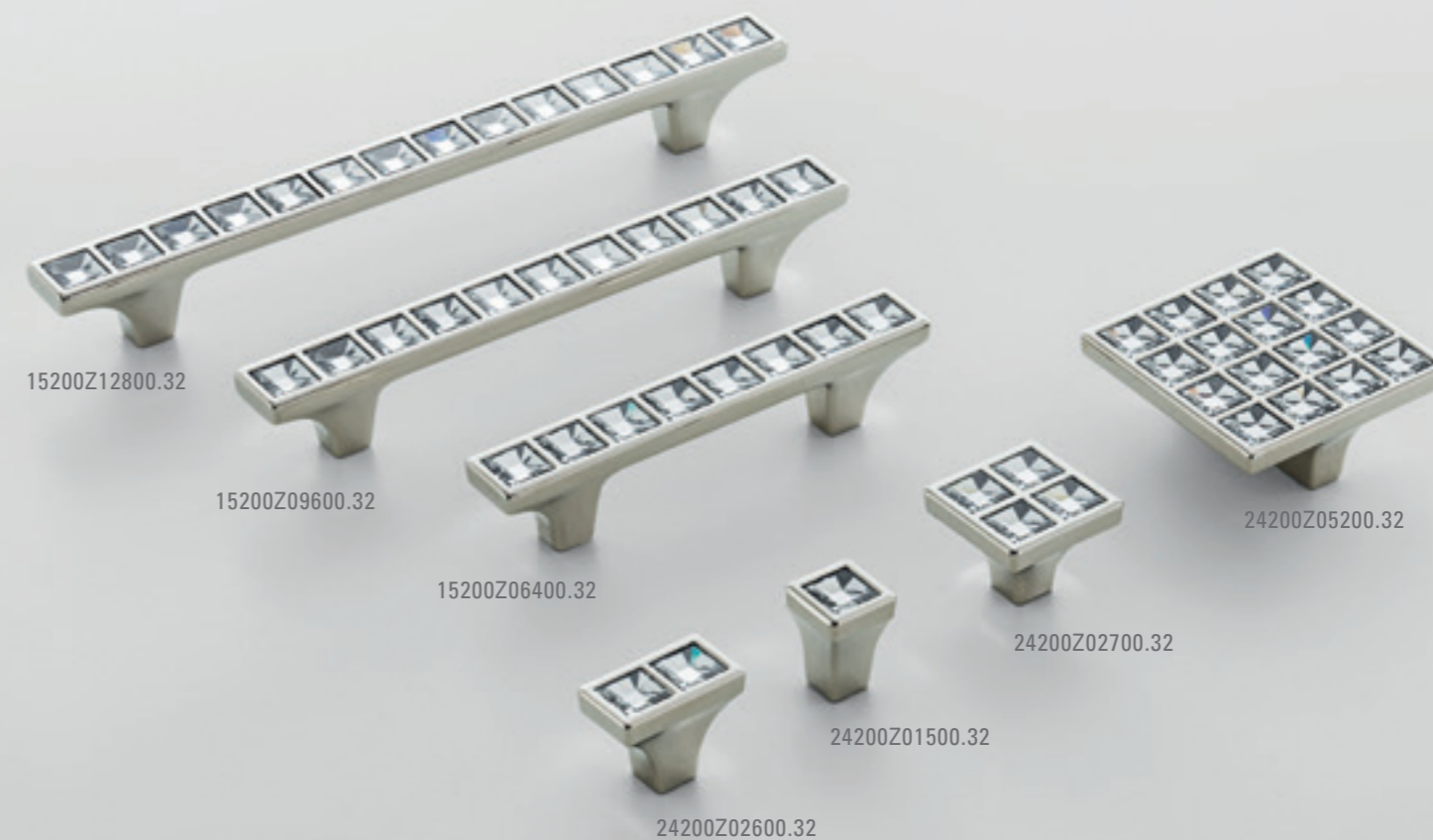

15200Z12800.32

15200Z09600.32

15200Z06400.32

24200Z02600.32

24200Z01500.32

24200Z02700.32

24200Z05200.32



CODICE <i>Code</i>	MISURE <i>Overall size</i>	INTERASSE <i>C.to C.</i>	CODICE <i>Code</i>	MISURE <i>Overall size</i>	INTERASSE <i>C.to C.</i>
15200Z12800	173x15x21	128	24200Z02700	27x27x21	-
15200Z09600	136x15x21	96	24200Z02600	27x15x21	-
15200Z06400	100x15x21	64	24200Z01500	15x15x21	-
24200Z05200	52x52x21	32			



Maniglia incasso / Insert pull

DESIGN: MARELLA DESIGN LAB

Serie realizzabile in tutte le finiture indicate a catalogo / Series available in all finishes in the catalogue.

C.483

Elite



Finitura / Finish: 32 - Nickel lucido / Bright Nickel



45200Z06100.32

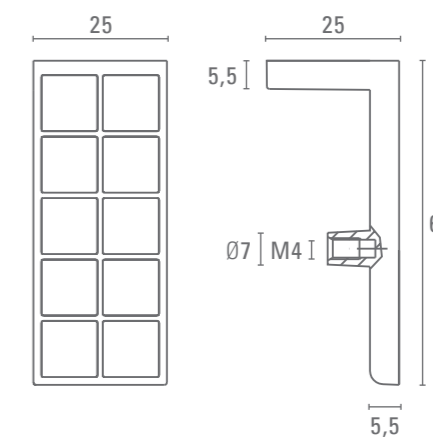

CODICE
Code
45200Z06100

MISURE
Overall size
25x61x25

INTERASSE
C. to C.
-



15202

DESIGN: MARELLA DESIGN LAB

Serie realizzabile in tutte le finiture indicate a catalogo / Series available in all finishes in the catalogue.

C.485

Finitura / Finish: 32 - Nickel lucido / Bright Nickel



Elite



CODICE <i>Code</i>	MISURE <i>Overall size</i>	INTERASSE <i>C. to C.</i>
15202Z16000	219x30x34	160
15202Z06400	111x30x34	64
24202Z05700	57x57x29	32
24202Z03000	30x30x29	-



Inserto decorativo / Insert decoration

DESIGN: MARELLA DESIGN LAB

Serie realizzabile in tutte le finiture indicate a catalogo / Series available in all finishes in the catalogue.

C.487

Elite

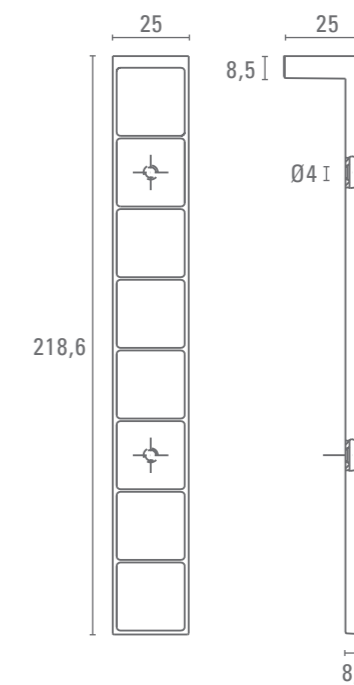

CODICE
Code
45200Z21900

MISURE
Overall size
29x219x32

INTERASSE
C. to C.
-



Inserto decorativo / Insert decoration

DESIGN: MARELLA DESIGN LAB

Serie realizzabile in tutte le finiture indicate a catalogo / Series available in all finishes in the catalogue.

C.489

Elite

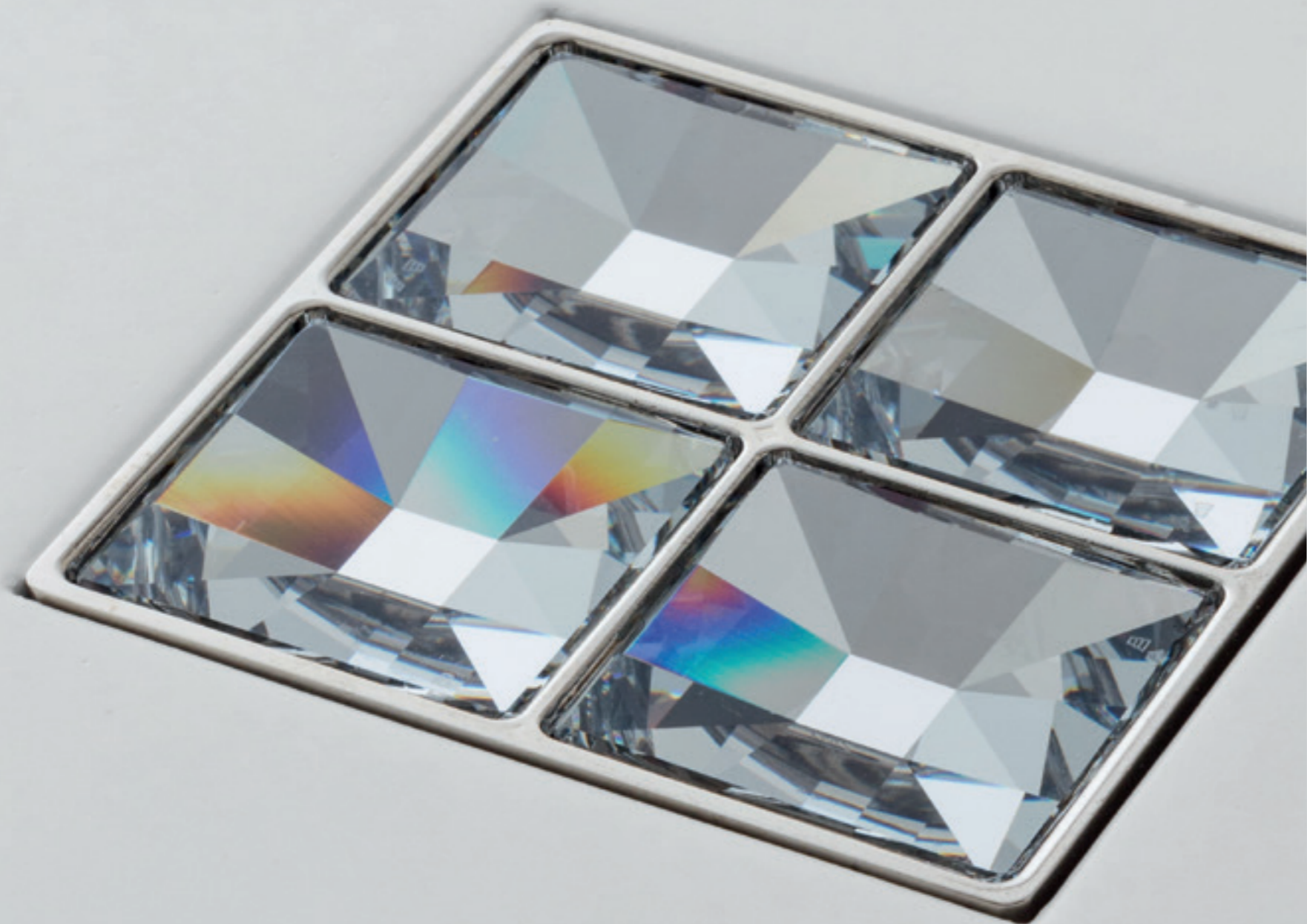

Finitura / Finish: 32 - Nickel lucido / Bright Nickel

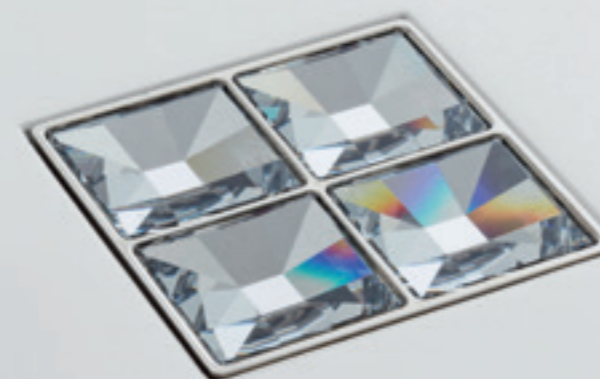

45200Z05500

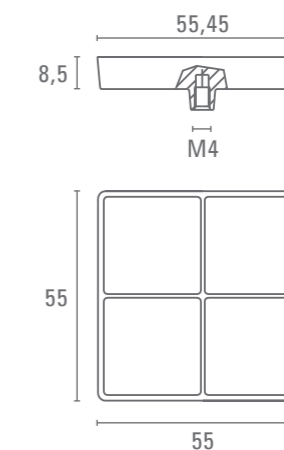

CODICE
Code
45200Z05500

MISURE
Overall size
25x61x25

INTERASSE
C. to C.
-



Ambra e Madreperla / Amber and Mother of Pearl

Ambra e Madreperla

Due prestigiose collezioni con inserti in vera ambra e madreperla. L'ambra, una resina, la cui fossilizzazione avviene dopo milioni di anni e dalle varietà geografiche differenti; La madreperla, dal colore iridescente e perlaceo, ricavato dallo strato interno della conchiglia di alcuni molluschi. Inserti pregiati, preziosi e naturali che arricchiscono il design delle maniglie **Marella Design**. Per la natura stessa di questi preziosi materiali, ogni inserto è da considerarsi come prodotto artigianale, unico nel suo genere e non riproducibile. La qualità dei materiali e la cura nella lavorazione garantiscono l'elevato standard qualitativo del prodotto.

Amber and Mother of Pearl

Two prestigious collections with natural amber and mother of pearl inserts. Amber is a resin, whose fossilization takes place after millions of years and from different geographic varieties; The mother-of-pearl, iridescent and pearly, is obtained from the shell's inner layer of some molluscs. Precious and natural inserts that enrich the design of Marella Design handles. Due to the nature of these precious materials, each insert has to be considered as a handcraft product, unique and not reproducible. The Quality of the materials and the care in the workmanship guarantee the high quality standard of the product.

Madreperla / Mother of Pearl

DESIGN: MARELLA DESIGN LAB

Serie realizzabile in tutte le finiture indicate a catalogo / Series available in all finishes in the catalogue.

C.492

Pietre Naturali

Finitura / Finish: 32 - Nickel lucido / Bright Nickel

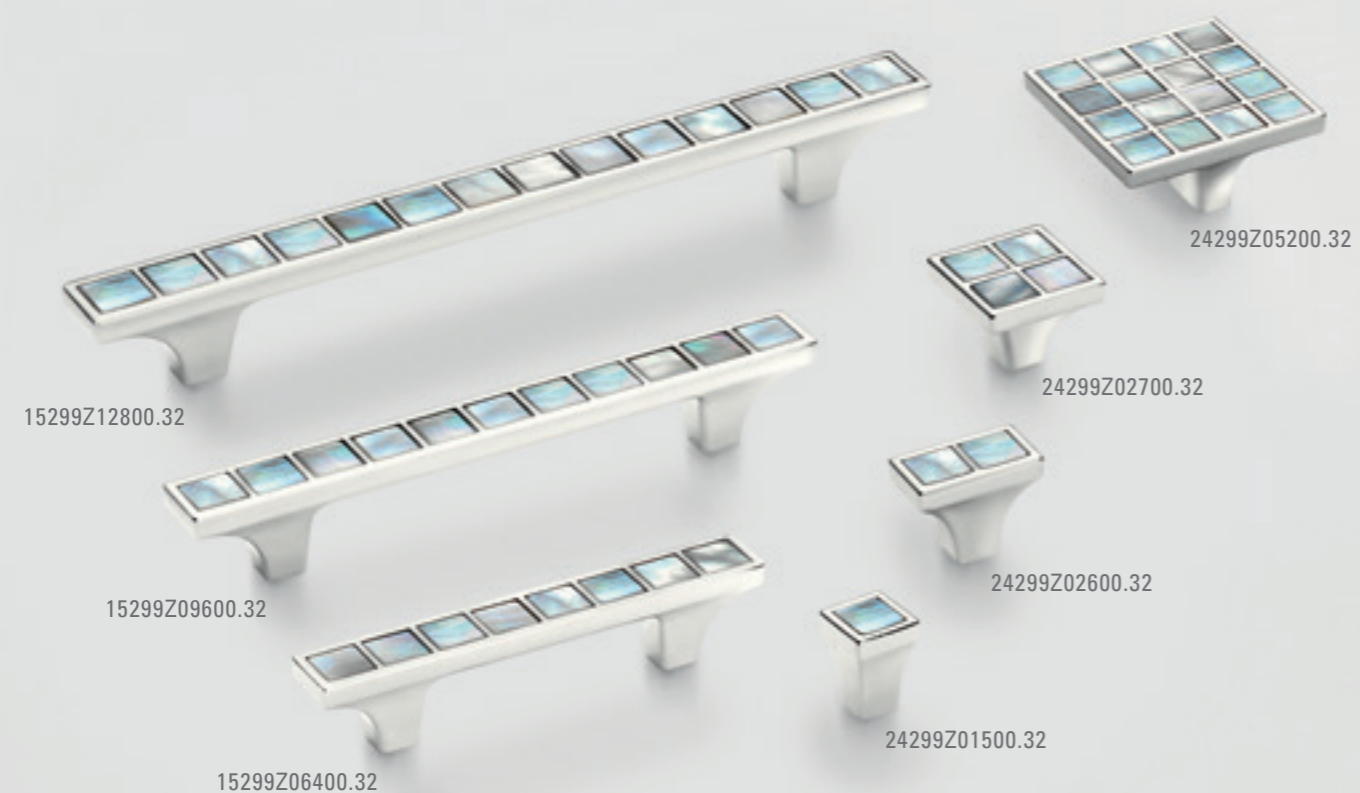

Madreperla / Mother of Pearl

DESIGN: MARELLA DESIGN LAB

Serie realizzabile in tutte le finiture indicate a catalogo / Series available in all finishes in the catalogue.

C.493

Pietre Naturali

Finitura / Finish: 32 - Nickel lucido / Bright Nickel



CODICE Code	MISURE Overall size	INTERASSE C.to C.
15299Z12800	173x15x21	128
15299Z09600	136x15x21	96
15299Z06400	100x15x21	64
24299Z05200	52x52x21	32

CODICE Code	MISURE Overall size	INTERASSE C.to C.
24299Z02700	27x27x21	-
24299Z02600	27x15x21	-
24299Z01500	15x15x21	-

CODICE Code	MISURE Overall size	INTERASSE C.to C.
15302Z16000	219x30x34	160
15302Z06400	111x30x34	64
24302Z05700	57x57x29	32
24302Z03000	30x30x29	-

Finitura / Finish: 32 - Nickel lucido / Bright Nickel



Maniglia incasso / Insert pull

DESIGN: MARELLA DESIGN LAB

Serie realizzabile in tutte le finiture indicate a catalogo / Series available in all finishes in the catalogue.

C.495

Finitura / Finish: 32 - Nickel lucido / Bright Nickel

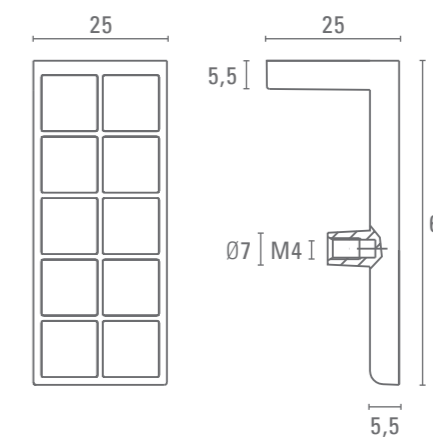

CODICE
Code
45302Z06100

MISURE
Overall size
25x61x25

INTERASSE
C. to C.
-

Pietre Naturali



Inserto decorativo / Insert decoration

DESIGN: MARELLA DESIGN LAB

Serie realizzabile in tutte le finiture indicate a catalogo / Series available in all finishes in the catalogue.

C.497

Pietre Naturali

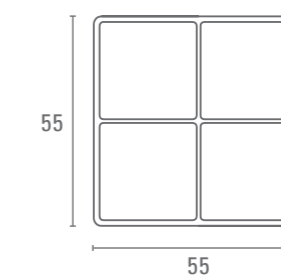
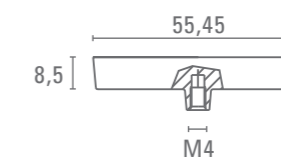
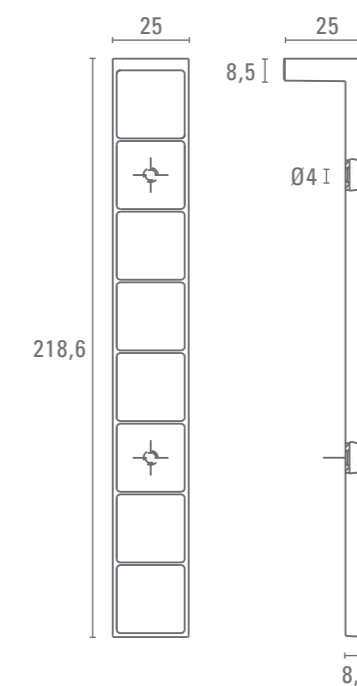
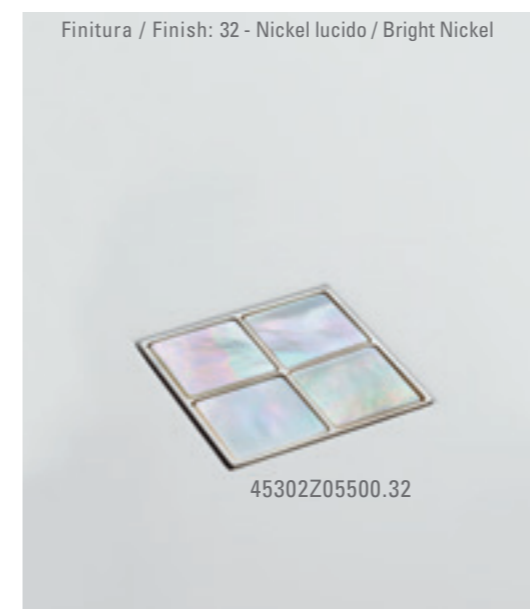

CODICE <i>Code</i>	MISURE <i>Overall size</i>	INTERASSE <i>C. to C.</i>
45302Z21900	29x219x32	-
45302Z05500	25x61x25	-

Ambra/Amber

DESIGN: MARELLA DESIGN LAB

Serie realizzabile in tutte le finiture indicate a catalogo / Series available in all finishes in the catalogue.

Ambra/Amber

DESIGN: MARELLA DESIGN LAB

Serie realizzabile in tutte le finiture indicate a catalogo / Series available in all finishes in the catalogue.

Finitura / Finish: 32 - Nickel lucido / Bright Nickel

Finitura / Finish: 32 - Nickel lucido / Bright Nickel

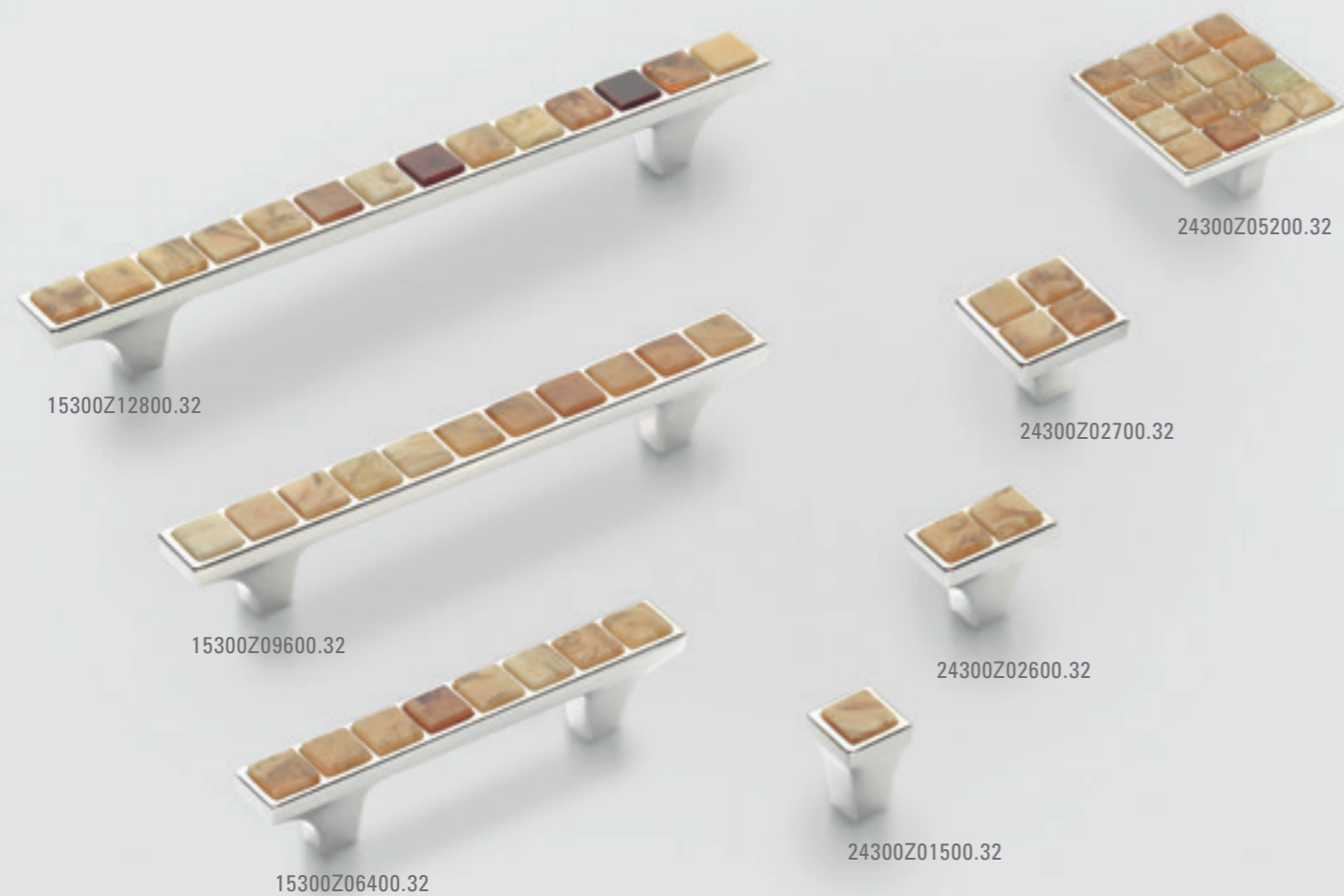

CODICE <i>Code</i>	MISURE <i>Overall size</i>	INTERASSE <i>C. to C.</i>
15300Z12800	173x15x21	128
15300Z09600	136x15x21	96
15300Z06400	100x15x21	64
24300Z05200	52x52x21	32

CODICE <i>Code</i>	MISURE <i>Overall size</i>	INTERASSE <i>C. to C.</i>
24300Z02700	27x27x21	-
24300Z02600	27x15x21	-
24300Z01500	15x15x21	-

CODICE <i>Code</i>	MISURE <i>Overall size</i>	INTERASSE <i>C. to C.</i>
15303Z16000	219x30x34	160
15303Z06400	111x30x34	64
24303Z05700	57x57x29	32
24303Z03000	30x30x29	-

Finitura / Finish: 32 - Nickel lucido / Bright Nickel



Maniglia incasso / Insert pull

DESIGN: MARELLA DESIGN LAB

Serie realizzabile in tutte le finiture indicate a catalogo / Series available in all finishes in the catalogue.

C.501

Finitura / Finish: 32 - Nickel lucido / Bright Nickel



45303Z06100.32

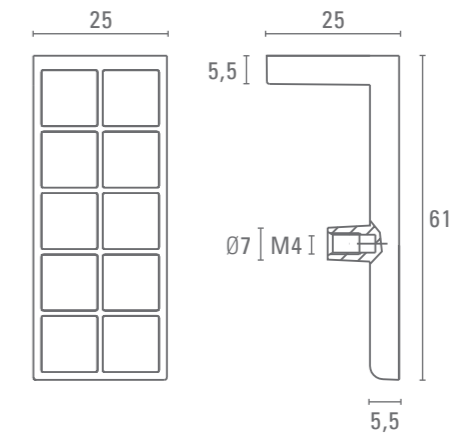

CODICE
Code
45303Z06100

MISURE
Overall size
25x61x25

INTERASSE
C. to C.
-

Pietre Naturali



Inserto decorativo / Insert decoration

DESIGN: MARELLA DESIGN LAB

Serie realizzabile in tutte le finiture indicate a catalogo / Series available in all finishes in the catalogue.

C.503

Pietre Naturali

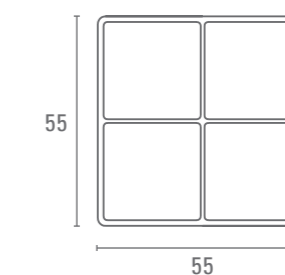
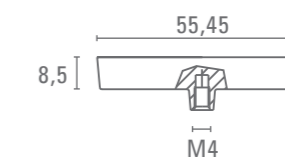
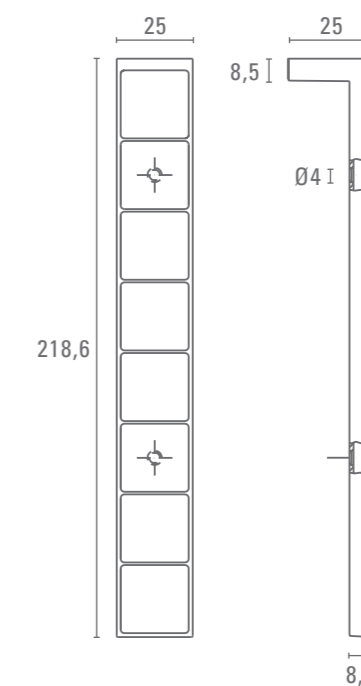

CODICE <i>Code</i>	MISURE <i>Overall size</i>	INTERASSE <i>C. to C.</i>
45303Z21900	29x219x32	-
45303Z05500	25x61x25	-

Aurea

“Aurea” è l'esclusiva collezione di maniglie e pomoli firmati **Marella Design** dedicata a chi ricerca l'eccellenza ed ama circondarsi di oggetti preziosi esclusivi nell'estetica e nel design. I materiali lavorati con concetti di oreficeria trasformano la maniglia in un dettaglio inconfondibile e caratterizzante, avente lo stesso compito estetico che un gioiello ha rispetto al corpo umano.

Maniglie e pomoli con copertura bagno oro 24kt e copertura 100% argento con vernice protettiva a salvaguardia della resistenza del prodotto nel tempo. I prodotti sono interamente fabbricati in Italia, materiali pregiati e maestria, certificati da costanti controlli di Qualità a garanzia del prodotto. Alta qualità, estro e maestria nella lavorazione, permettono di ottenere pezzi unici dai dettagli luminosi che racchiudono audaci dichiarazioni di opulenza con particolari carichi di espressività.

La ricchezza e il fascino della serie **Aurea** rievocano località esotiche lontane ed altre a noi più vicine: La Domus Aurea di Nerone, la Golden Pagoda di Myanmar, La Ca' d'Oro di Venezia, il Golden Temple di Harmandir Sahib, La Torre del Oro di Siviglia, la Stadhuset, sala d'oro, di Stoccolma e il Corno d'oro di Istanbul, la cui leggenda narra che i bizantini vi avessero gettato un numero tale di oggetti preziosi da rendere le acque luccicanti d'oro.

La pulizia delle maniglie e dei pomoli può effettuarsi con un panno morbido e umido, evitando sempre l'impiego di creme e detergenti abrasivi. I prodotti Aurea illustrati sono disponibili solo nelle finiture indicate

Aurea is the exclusive collection of handles and Knobs by Marella Design dedicated to those interested in precious objects, exclusive in aesthetical aspects and design for satisfying the high demanding customers. Quality materials and handicraft skills let the handles become a wonderful and unmistakable detail, having the same task a jewel has for the human body.

Handles and knobs covered by 24kt golden and 100% silver finishes, with a special printing process for the protection of the product over the time. An exclusive collection 100% MADE IN ITALY, high quality materials and handcraft skill, guaranteed by constant quality controls for an exclusive detail for your furniture. High quality materials and inspiration for special pieces with brilliant details rich of intensity: a daring declaration of opulence.

The opulence and the appeal of Aurea collection remind remote places such as: The Domus Aurea of Nerone, the Golden Pagoda of Myanmar, the Ca' d'Oro in Venice, the golden Temple in Harmandir Sahib, the Golden tour in Siviglia, the Stadhuset, golden room, in Stocholm and the golden Golden horn of Istanbul, the legend tells that Byzantine, threw down the water so many precious objects that made the water gold sparkling. Sparkling and fascinating like the handles of **Aurea** Collection.

We recommend to clean handles and knobs with a wet and soft cloth avoiding to use alcohol or any kind of detergent. Products represented are available in the finishes shown.

Aurea

DESIGN: MARELLA DESIGN LAB

Serie realizzabile in tutte le finiture indicate a catalogo / *Series available in all finishes in the catalogue.*

Finitura / Finish: 70 - Imperial Gold



EA036Z096S0.70



EA036Z064S0.70



IA108Z03000.70

Aurea

DESIGN: MARELLA DESIGN LAB

Serie realizzabile in tutte le finiture indicate a catalogo / *Series available in all finishes in the catalogue.*

Finitura / Finish: 70 - Imperial Gold



EA036Z096D0.70



EA036Z064D0.70



IA108Z04500.70

CODICE <i>Code</i>	MISURE <i>Overall size</i>	INTERASSE <i>C. to C.</i>
EA036Z096S0	138x32x27	96
EA036Z064S0	95x22x24	64
IA108Z03000	30x20	Ø 30

CODICE <i>Code</i>	MISURE <i>Overall size</i>	INTERASSE <i>C. to C.</i>
EA036Z096D0	138x32x27	96
EA036Z064D0	95x22x24	64
IA108Z04500	45x24	Ø 45

Aurea

DESIGN: MARELLA DESIGN LAB

Serie realizzabile in tutte le finiture indicate a catalogo / Series available in all finishes in the catalogue.

Finitura / Finish: 69 - Moonlight silver



EA036Z096S0.69



EA036Z064S0.69



IA108Z03000.69

Aurea

DESIGN: MARELLA DESIGN LAB

Serie realizzabile in tutte le finiture indicate a catalogo / Series available in all finishes in the catalogue.

Finitura / Finish: 69 - Moonlight silver



EA036Z096D0.69



EA036Z064D0.69



IA108Z04500.69

CODICE <i>Code</i>	MISURE <i>Overall size</i>	INTERASSE <i>C.to C.</i>
EA036Z096S0	138x32x27	96
EA036Z064S0	95x22x24	64
IA108Z03000	30x20	Ø 30

CODICE <i>Code</i>	MISURE <i>Overall size</i>	INTERASSE <i>C.to C.</i>
EA036Z096D0	138x32x27	96
EA036Z064D0	95x22x24	64
IA108Z04500	45x24	Ø 45

Aurea

DESIGN: MARELLA DESIGN LAB

Serie realizzabile in tutte le finiture indicate a catalogo / *Series available in all finishes in the catalogue.*

Finitura / Finish: 69 - Moonlight silver



EA308Z09600.69

IA108Z04500.69

IA108Z03000.69

Aurea

DESIGN: MARELLA DESIGN LAB

Serie realizzabile in tutte le finiture indicate a catalogo / *Series available in all finishes in the catalogue.*

Finitura / Finish: 70 - Imperial gold



EA308Z09600.70

IA108Z04500.70

IA108Z03000.70

CODICE <i>Code</i>	MISURE <i>Overall size</i>	INTERASSE <i>C.to C.</i>
EA308Z09600	127x30x26	-
IA108Z04500	45x24	Ø 45
IA108Z03000	30x20	Ø 30

CODICE <i>Code</i>	MISURE <i>Overall size</i>	INTERASSE <i>C.to C.</i>
EA308Z09600	127x30x26	-
IA108Z04500	45x24	Ø 45
IA108Z03000	30x20	Ø 30

Aurea

DESIGN: MARELLA DESIGN LAB

Serie realizzabile in tutte le finiture indicate a catalogo / *Series available in all finishes in the catalogue.*

Finitura / Finish: 70 - Imperial Gold



EC065Z160S0.70



EC065Z096S0.70



IC165Z03500.70

Aurea

DESIGN: MARELLA DESIGN LAB

Serie realizzabile in tutte le finiture indicate a catalogo / *Series available in all finishes in the catalogue.*

Finitura / Finish: 70 - Imperial Gold



EC065Z160D0.70



EC065Z096D0.70



IC165Z03500.70

CODICE <i>Code</i>	MISURE <i>Overall size</i>	INTERASSE <i>C.to C.</i>
EC065Z160S0	172x57x25	160
EC065Z096S0	107x37x24	96
IC165Z03500	35x33x24	-

CODICE <i>Code</i>	MISURE <i>Overall size</i>	INTERASSE <i>C.to C.</i>
EC065Z160D0	172x57x25	160
EC065Z096D0	107x37x24	96
IC165Z03500	35x33x24	-

Aurea

DESIGN: MARELLA DESIGN LAB

Serie realizzabile in tutte le finiture indicate a catalogo / Series available in all finishes in the catalogue.

Finitura / Finish: 69 - Moonlight silver



EC065Z160S0.69



EC065Z096S0.69



IC165Z03500.69

Aurea

DESIGN: MARELLA DESIGN LAB

Serie realizzabile in tutte le finiture indicate a catalogo / Series available in all finishes in the catalogue.

Finitura / Finish: 69 - Moonlight silver



EC065Z160D0.69



EC065Z096D0.69



IC165Z03500.69

CODICE <i>Code</i>	MISURE <i>Overall size</i>	INTERASSE <i>C. to C.</i>
EC065Z160S0	172x57x25	160
EC065Z096S0	107x37x24	96
IC165Z03500	35x33x24	-

CODICE <i>Code</i>	MISURE <i>Overall size</i>	INTERASSE <i>C. to C.</i>
EC065Z160D0	172x57x25	160
EC065Z096D0	107x37x24	96
IC165Z03500	35x33x24	-

Finiture/Finishes

Crediamo fortemente nella Ricerca e Sviluppo, per questo abbiamo ampliato la nostra gamma con colorazioni ed effetti che, seguendo i trend del momento, donano carattere ed espressione.

We strongly believe in R & D, for this reason we have expanded our range with colors and effects that, following the trends of the moment, give character and expression.

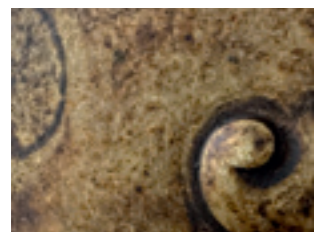

03
Ottone Antico /
Antique brass

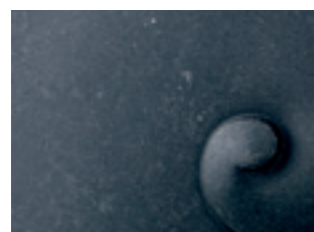

05
Brunito / Burnished



06
Patinè France



07
Oro di Valenza



09
Florence

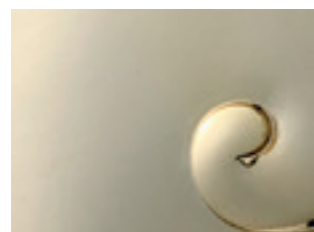

11
Ottone lucido /
Polished brass



12
Ottone satinato /
Satin brass

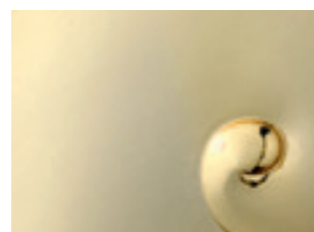

15
Bagno Oro /
Gold plated



19
Similferro /
Similiron



20
Rustico



22
Old America

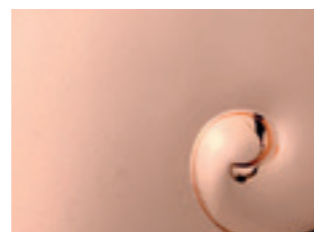

23
Rame Lucido /
Bright copper

Finiture/Finishes



25
Argento Vecchio /
Old silver



28
Patinè Paris



29
Ramato Antico /
Antique copper



31
Nickel Opaco /
Mat nickel



32
Nickel lucido /
Bright nickel



34
Nickel Satinato /
Satin nickel Inox Aspect



36
Cromo lucido /
Bright chrome



41
Golden White



45
Cromo opaco /
Mat chrome



46
Oro Opaco / Mat gold



47
Argento Orientale /
Oriental silver



48
Canna di Fucile

Finiture/Finishes

C.518

Dati Tecnici



52
Silver White



54
Patiné BM



69
Moonlight Silver
100% Silver cover

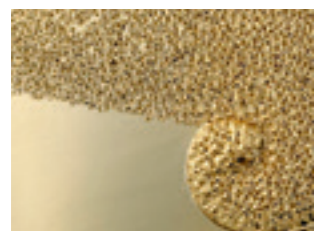

70
Imperial Gold
24 Kt Gold Cover



75
Bronze medaille



76
Cor-Ten effect



78
Bagno Argento /
Silver plated



82
Kassite

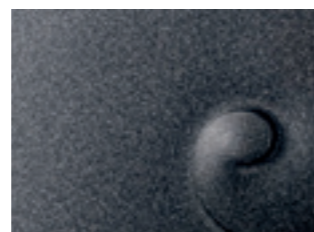

83
Graphite



84
Cromo Satinato /
Satin chrome



85
Effetto Titanio /
Titanium effect



87
Old Factory

Finiture/Finishes

C.519

Dati Tecnici



90
Terra di Siena



91
Pewter



92
Decapé



93
Velvet gold

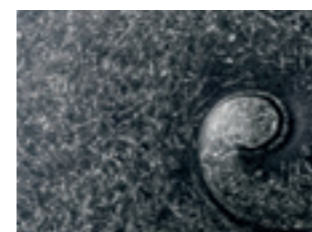

94
Iron Effect

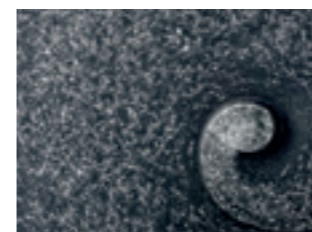

95
Iron Effect Mat



96
Cromo opaco verniciato /
Mat chrome painted

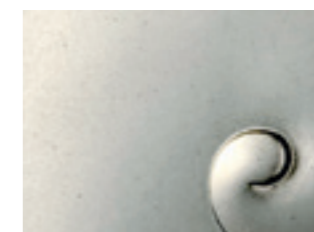

97
Nickel opaco verniciato /
Mat nickel painted



98
Tobacco



DC
Rame satinato /
Brushed copper



DD
Cover silver



DE
Cover copper

Finiture/Finishes

C.520

Dati Tecnici



DF
Bright bronze

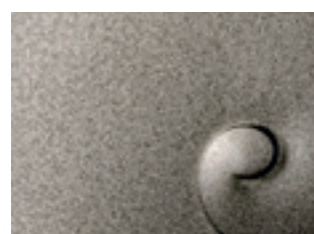

DG
London grey



DH
Golden shadow



DI
Effetto cemento



DL
Rock



DM
Watery stone

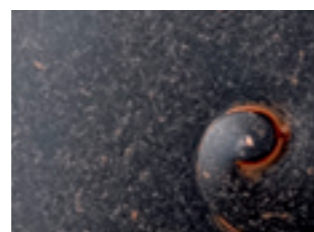

DN
Rust looking



DO
Watery rust



DP
Ocre vintage



DQ
Blue washed



DR
Ivory gold



DS
Ottone / Brass

Finiture/Finishes

C.521

Dati Tecnici



DT
Gold treasure



DU
Refined gold 24 Kt



DV
Refined silver



F4
Bianco lucido /
Bright white - RAL 9010



F5
Bianco opaco /
Mat white - RAL 9010



N1
Nero lucido /
Bright black - RAL 9005



N2
Nero opaco /
Mat black - RAL 9005

Le texture e i colori delle finiture rappresentate hanno valore identificativo in quanto soggetti alle tolleranze dei processi di stampa.
The texture and colors of finishes are not binding because they depend on printing colors tolerances.

I nomi delle finiture sono nomi di fantasia e hanno valore puramente commerciale.
Finishes names are fancy names and have a purely commercial value.

Indice/Index

C.522

CODICE CODE	PAGINA PAGE	CODICE CODE	PAGINA PAGE	CODICE CODE	PAGINA PAGE	CODICE CODE	PAGINA PAGE
03002Z	C286	06014Z	C267	06888.	C376	12327.	C310
03004.	C334	06025.	C360	06996.	C393	12328.	C309
03006.	C383	06032Z	C363	06999.	C388	12330.	C353
03007.	C383	06060Z	C320	09015.	C257	12331.	C299
03013.	C292	06144Z	C216	09145Z	C294	12350Z	C354
03019.	C206	06145Z	C294	09202.	C245	12446Z	C296
03020.	C204	06213.	C337	09204.	C329	12500.	C306
03023.	C205	06214.	C337	09207.	C380	12563Z	C243
03025.	C374	06215.	C385	09208.	C246-379	12655Z	C248
03027.	C209	06216.	C300	09213Z	C242	12656Z	C248
03028.	C207	06217.	C301	09216Z	C242	12712Z	C250
03029.	C384	06218.	C302	09220.	C299	12713Z	C250
03030Z	C290	06219.	C303	09225.	C245	12714Z	C250
03035.	C293	06220.	C304	09226.	C246	12820Z	C243
03037.	C366	06221.	C305	09229.	C321	12887.	C376
03038.	C371	06222.	C372	09233.	C309-310	12888.	C376
03042.	C375	06224Z	C265	09234.	C245	12995.	C393
03049Z	C270	06285.	C291	09236.	C359	12996.	C393
03050.	C342	06286Z	C288	09238.	C358	12997.	C392-393
03051.	C344	06300.	C363	09239.	C342	12998.	C389
03058Z	C275	06304.	C364	09446Z	C296	12999.	C388
03064.	C208	06305.	C298	12020Z	C337	15029Z	C274
03070Z	C242	06308.	C260	12060Z	C320	15036Z	C128-129
03071P	C451	06309.	C244	12145Z	C294	15037Z	C161
03075Z	C381	06311.	C360	12210.	C350	15038Z	C133
03085.	C338	06312Z	C370	12212Z	C357	15045Z	C185
03087.	C380	06313.	C365	12223.	C318	15046Z	C147
03088.	C309-310	06320.	C382	12224.	C352	15049Z	C155
03092.	C368	06320Z	C266	12230.	C247	15050Z	C122
03093.	C340	06322.	C318	12231.	C318	15051Z	C153
03094.	C299	06323Z	C319	12232.	C322	15052.	C285
03101Z	C272	06324.	C310	12232Z	C323	15053Z	C132
03103.	C363	06325.	C367	12233Z	C319	15054Z	C123
03144Z	C216	06327.	C267-382	12235.	C359	15055Z	C155
03145Z	C294	06328.	C309	12236.	C351	15056Z	C164
03158.	C117	06330.	C322	12237.	C321	15057Z	C151
03213.	C337	06330Z	C323	12238.	C358	15058Z	C119
03325.	C307	06331.	C321	12321.	C247	15059Z	C183
03446Z	C296	06332Z	C324	12323Z	C319	15060Z	C165
03850.	C372	06446Z	C296	12324.	C311	15061Z	C152
03995.	C393	06655Z	C248	12326Z	C324	15062.	C283

Indice/Index

C.523

CODICE CODE	PAGINA PAGE	CODICE CODE	PAGINA PAGE	CODICE CODE	PAGINA PAGE	CODICE CODE	PAGINA PAGE
15063Z	C181	15116Z	C252	15169Z	C45	18063Z	C125
15064E	C190-191-192-193	15117Z	C258	15170.	C200-201	18119Z	C349
15064Z	C170-171	15118.	C347	15170L	C197	18230Z	C281
15065Z	C134-135	15119Z	C348	15171.	C200-201	18326.	C308
15067Z	C167	15120.	C234	15172.	C200-201	18327.	C308
15070Z	C141	15120Z	C235	15173.	C200-201	18328.	C325
15071Z	C152	15121.	C238	15175E	C198	18329.	C326-327
15072Z	C127	15122.	C232-394	15176P	C413-421	18330.	C228
15074Z	C255	15123.	C232-394	15177Z	C88-C89	18900.	C227
15075Z	C75	15124Z	C239	15178P	C399-411	18994.	C390-391
15076Z	C71	15125Z	C139-239	15179Z	C27	21008Z	C272
15077Z	C140	15127Z	C269-382	15197Z	C15	21009Z	C280
15078Z	C99	15128Z	C225	15200Z	C479	21119Z	C348
15079Z	C103	15129Z	C229	15202Z	C483	21150.	C199
15081Z	C188	15130Z	C280	15203Z	C149	21170L	C197
15082Z	C121	15131Z	C269-382-383	15204Z	C149	21175E	C198
15083Z	C167	15132Z	C179	15208Z	C49	21379.	C205
15084Z	C173	15133Z	C187	15211Z	C51	21391.	C341
15085Z	C159	15134Z	C212-213	15213Z	C55	21392.	C343
15086Z	C157	15135.	C329	15214Z	C31	21395Z	C261-364-370
15087Z	C177	15136P	C423-449	15217Z	C19	21396.	C206-369
15089Z	C189	15137Z	C174	15229Z	C59	21397.	C380-381
15090Z	C143	15138.	C230-276	15230Z	C281	21398.	C208
15092Z	C451	15139.	C230-394	15231Z	C63	21399.	C344
15096Z	C269	15141P	C423-449	15256Z	C97	21800Z	C286
15097Z	C11	15144Z	C215-217	15258Z	C112	21801Z	C270
15099Z	C39	15146Z	C214	15259Z	C473	21802Z	C290
15101.	C317	15147Z	C263	15299Z	C490	21803Z	C253-259
15103Z	C231	15148Z	C239	15300Z	C496	21850.	C373
15104.	C230	15150.	C199	15302Z	C491	22006Z	C253-259
15105Z	C259	15150Z	C200-201	15303Z	C497	22007Z	C290
15106Z	C333	15155Z	C67	15308Z	C131	22008Z	C273
15107.	C330	15157Z	C111	15331.	C336	22009Z	C280
15108.	C316	15159Z	C80	15332Z	C241	22119Z	C289-348-349
15109Z	C332	15160Z	C81-85	15333Z	C241	22203.	C341
15111.	C315	15161Z	C82	15341.	C276	22207.	C343
15112.	C316	15162Z	C35	15342.	C277	22208.	C339
15113.	C315	15163Z	C105	15375Z	C106-C107	22209.	C345
15114Z	C223	15164Z	C93	15375Z.1	C474-475	22800Z	C287
15115Z	C270	15165Z	C23	15900.	C226	22801Z	C271
		15166Z	C43	18062.	C313	24037Z	C161

Indice/Index

CODICE CODE	PAGINA PAGE	CODICE CODE	PAGINA PAGE
24064E	C190-191-192-193	24221Z	C270-272-275
24064Z	C170-171	24222Z	C265-357
24073Z	C147-185	24223Z	C286-349
24075Z	C75	24224Z	C252-274-317
24081Z	C188	24228.	C378
24083Z	C123-167	24229Z	C59
24084Z	C173	24231Z	C63
24085Z	C159	24250Z	C122
24086Z	C157	24256Z	C97
24087Z	C125-177	24258Z	C113
24089Z	C49-189	24259Z	C473
24090Z	C143	24260Z	C258-259
24099Z	C39	24261Z	C346
24108Z	C128-131	24264Z	C355
24124Z	C51	24273Z	C464-469
24125Z	C139	24274Z	C455-461
24126Z	C67	24286Z	C288
24130Z	C280	24299Z	C490
24134Z	C212-213	24300Z	C496
24136P	C423-449	24302Z	C491
24137Z	C174	24303Z	C497
24144Z	C217	24316P	C413-421-423-449
24147Z	C263	24401Z	C334-336
24154Z	C31	24402.	C382
24157Z	C111	24404Z	C347-350-353
24159Z	C80	24405.	C307-308-340-351
24160Z	C81	24406Z	C208-364
24162Z	C35	24408Z	C183-366-367-370
24165Z	C134-135	24409.	C326
24166Z	C43	24410Z	C332
24169Z	C45	24446Z	C164-165-296
24172Z	C127	24452Z	C257-329-330
24176P	C413/421	24452Z.1	C474-475
24177Z	C88-C89	24459.	C292
24178P	C399/411	24460Z	C121-384
24200Z	C479	24463Z	C206
24202Z	C483	24470Z	C119-293
24204E	C195	24477Z	C205-285
24213Z	C55		
24216Z	C283-385		

CODICE CODE	PAGINA PAGE
24479Z	C339-352
24487Z	C209-380
24488Z	C181-374
24492.	C260-368
24494Z	C207
24496Z	C381
24499.	C204-360-375
24499Z	C204-360-375
24568Z	C267
24802Z	C290
24850Z	C313-373
24994.	C390
24999.	C392
25102.	C326
25105.	C244
25145Z	C294
25446Z	C296
25563Z	C243
25568Z	C267
25655Z	C249
25714Z	C251
25820Z	C243
25888.	C377
25994.	C390
25996.	C392
25999.	C388
27562.	C247
27563Z	C243
27564.	C244
27565Z	C369-371
27568Z	C267
27655Z	C249
27714Z	C251
27820Z	C243
27888.	C377
27999.	C388
30053Z	C149
30060Z	C320
30112Z	C357
30116.	C347
30144Z	C217

CODICE CODE	PAGINA PAGE
30145Z	C294
30150.	C199
30158.	C117
30162.	C313
30224Z	C265
30236Z	C129-131
30258Z	C112
30565.	C369-371
30568Z	C267
30600Z	C286
30605.	C331
30606Z	C270-272-275
30607.	C350
30608.	C208
30609.	C209
30611.	C206
30614.	C205-336
30616.	C285-307
30617.	C261
30618.	C383
30620.	C292
30621.	C367
30622.	C207
30623.	C374
30626.	C274-384
30630.	C364-380
30631.	C257-329-332
30632.	C308-344
30637.	C244
30638.	C361
30639.	C335
30640.	C332
30641.	C338
30642.	C352-359
30643.	C340-385
30645.	C351
30650Z	C319
30651Z	C253
30654.	C315
30655Z	C249
30667.	C247

Indice/Index

CODICE CODE	PAGINA PAGE
30676.	C318
30682.	C204-375
30684.	C311
30685.	C293
30687.	C309
30690.	C316
30692.	C298-299
30693.	C381
30698.	C327
30699.	C327
30700.	C322
30700Z	C323
30702.	C321
30703.	C358
30704.	C300
30705Z	C319
30706.	C301
30707.	C302
30708.	C303
30709.	C305
30710.	C342-353
30712Z	C324
30713.	C304
30714Z	C251
30730Z	C258-259
30733Z	C288-349-354
30850.	C373
30888.	C377
30994.	C390-391
30995.	C392
30996.	C392
30999.	C388-389
33002Z	C149
33004.	C388
33053.	C132
33108.	C129-131
33217.	C285-304-385
33700.	C378
33703.	C293
33706.	C208-369
33708.	C209-275

CODICE CODE	PAGINA PAGE
33710.	C331
33711.	C367
33712.	C374
33716Z	C258-259
33717.	C305-307
33718.	C117
33723.	C257-329-332
33724.	C335
33726.	C340-342-344-351
33726Z	C308
33727.	C261-296-358-371
33728.	C206-381
33728Z	C112-206-381
33729.	C352-359
33730.	C361-364
33731.	C205-207-274-336-384
33732.	C383
33733.	C265-347-350-353
33734.	C204-375-380
33850.	C313-373
35711.	C367
35724.	C334
35725.	C338
35730.	C364
37725.	C339
39037.	C389
43075Z	C79
43137Z	C175
43144Z	C218-219
43161Z	C83
45037Z	C160
45123.	C232-394
45124.	C233
45125.	C233
45144Z	C217
45145Z	C295
45200Z	C481-485-487

CODICE CODE	PAGINA PAGE
45255Z	C355
45302Z	C493-495
45303Z	C499-501
45446Z	C297
45947.	C382
45948.	C382
45949.	C382
45984Z	C357
EA036Z	C504-506-505-507
EA308Z	C508-509
EC065Z	C510-512-513
IA108Z	C504-506-508-509
IC165Z	C510-511-512-513

Tutti gli articoli in questo catalogo sono ideati e realizzati interamente da **ROBERTO MARELLA S.p.A.** in collaborazione con designers di fama del settore.

*All items in this catalogue are designed and manufactured by **ROBERTO MARELLA S.p.A.** in collaboration with renowned designers of the sector.*
Copyright©2017 ROBERTO MARELLA S.p.A.

È vietata ogni riproduzione con qualunque mezzo, senza preventiva autorizzazione scritta da parte di ROBERTO MARELLA S.p.A. Ogni trasgressione sarà punita a norma di legge.

Bosetti Marella e Marella Design sono marchi commerciali registrati di proprietà ROBERTO MARELLA S.p.A.

No parts of this work may be reproduced or copied in any way or by any means, without written permission from ROBERTO MARELLA S.p.A. Violators will be prosecuted.

Bosetti Marella and Marella Design are registered trademarks of ROBERTO MARELLA S.p.A.

Tutte le misure sono espresse in mm. / All sizes are in mm.

AVVERTENZE

ROBERTO MARELLA S.p.A. si riserva la facoltà di modificare le caratteristiche tecniche dei prodotti a catalogo, in qualunque momento. Per ragioni tecniche, le tonalità dei colori nelle fotografie, possono non rappresentare fedelmente la realtà. Si raccomanda la pulizia con panno umido, evitando l'impiego di detersivi

ATTENTION

ROBERTO MARELLA S.p.A. reserves the right to change technical details of products illustrated in this catalogue, whenever necessary.
Due to technical reasons, pictures colors could be different from the original colors.
We recommend to clean our products with a dry cloth, avoiding the use of detergents or alcohol.



MARELLA

100% MADE IN ITALY

ROBERTO MARELLA S.p.A.

Via Enrico Fermi, 19

25030 Roccafranca fraz. Ludriano (BS) - ITALY

Tel. +39 030 7093111

Fax. +39 030 7093151

E-mail: info@robertomarellaspa.it

www.marelladesign.it