

ESTAMP[®]
High quality handles

ESTAMP[®]
High quality handles

ESTAMP

Herrajes para muebles / Garnitures pour meubles / Furniture fittings / Möbelbeschläge



J.JOSÉ VERGÉS S.A.
1928
Avda. de Cornellà, 140 bajos
Edificio LEKLA
08950 Esplugues de Llobregat
Barcelona - Spain
Tel. Nacional 933 713 954*
Fax Nacional 933 725 302
International Tel. 34 933 713 958*
International Fax 34 933 725 302
Email: estamp@verges.com
www.verges.com



J.JOSÉ VERGÉS S.A.
1928

J.JOSÉ VERGÉS S.A.
1928



ESTAMP[®]
High quality handles

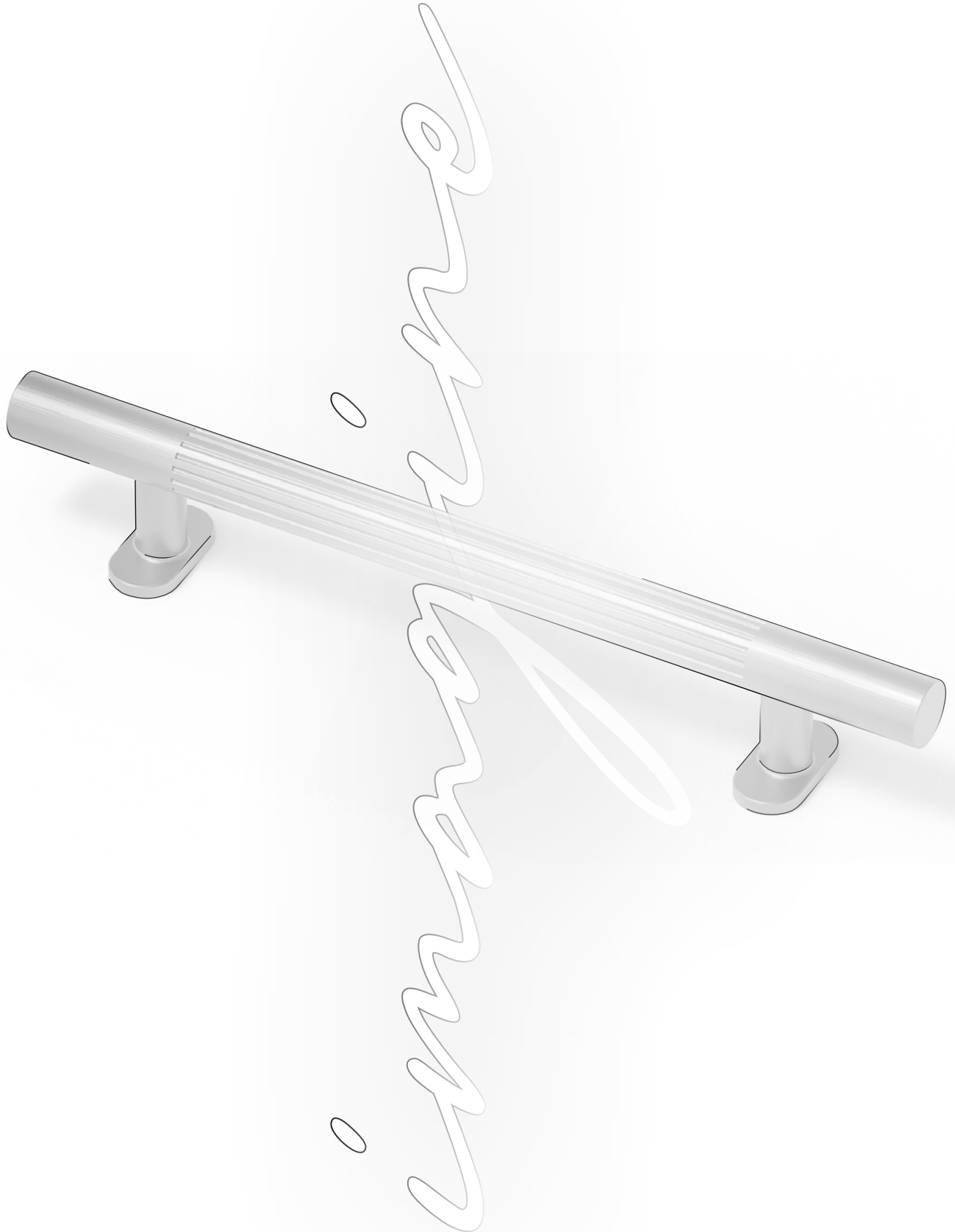

J. JOSÉ VERGÉS S.A.
1 9 2 8

Índice de referencias

Index de références

Index of references

Verzeichnis der Referenzen

102A	109	3512	69	6190	38	7002	76	7491	88	8090	63	8922	77
102B	109	3541	59	6191	38	7003	76	7492	88	8101	55	9011	17
102C	110	3542	59	6200	39	7004	76	7501	76	8102	55	9012	17
102D	110	3560	69	6201	39	7005	76	7502	76	8103	55	9062	79
102E	110	3561	69	6210	40	7006	76	7503	76	8151	46	9063	79
1000	107	3562	69	6211	40	7007	76	7504	76	8152	46	9090	57
1001	107	3600	69	6231	36	7008	76	7505	76	8161	47	9381	57
1002	107	3701	80	6232	36	7009	76	7506	76	8162	47	9382	57
1003	107	3702	80	6240	27	7010	77	7511	102	8171	47	9383	57
1004	107	3703	80	6241	26	7011	77	7512	102	8172	47	9400	16
1005	108	3720	60	6242	26	7012	77	7513	102	8181	21	9401	16
1006	108	3730	61	6521	84	7013	77	7520	62	8182	21	9402	16
1007	108	3740	60	6601	18	7014	77	7521	62	8191	90	9403	16
1008	108	3750	58	6602	18	7015	77	7531	53	8192	90	9404	16
1009	108	3760	34	6603	18	7016	77	7532	53	8321	74	9405	16
1020	107	3770	34	6604	18	7017	77	7541	55	8322	74	9411	15
1021	107	3780	34	6611	19	7018	77	7542	55	8323	74	9412	15
1022	107	3790	35	6612	19	7019	77	7543	55	8324	74	9413	15
1023	107	3801	83	6613	19	7020	62	7552	73	8341	22	9414	15
1024	107	3802	83	6614	19	7021	62	7553	73	8342	22	9501	96
1025	108	3900	83	6761	50	7022	62	7554	73	8351	74	9502	96
1026	108	3921	82	6762	50	7023	62	7570	52	8352	74	9551	96
1027	108	3922	82	6763	50	7024	62	7571	52	8353	74	9552	96
1028	108	3930	83	6764	50	7025	62	7572	52	8354	74	9651	96
1029	108	3940	80	6765	50	7026	62	7581	86	8361	78	9652	96
1030	109	3961	30	6781	44	7031	67	7582	86	8362	78	9700	94
1101	105	5001	78	6782	44	7032	67	7610	76	8363	78	9770	95
1102	105	5002	78	6791	41	7051	66	7611	76	8461	75	9771	95
1103	105	5101	78	6792	41	7052	66	7612	76	8462	75	9772	95
1104	105	5102	78	6801	36	7061	72	7613	76	8463	75	9821	93
1105	105	5201	79	6802	36	7081	72	7614	76	8471	75	9822	93
1106	106	5202	79	6803	36	7082	72	7651	58	8472	75	9831	93
1107	106	5221	79	6811	42	7131	66	7652	58	8473	75	9832	93
1108	106	5222	79	6812	42	7132	66	7653	58	8491	88	9841	94
1109	106	5611	98	6821	32	7140	66	7661	56	8521	84	9842	94
1801	48	5612	98	6822	32	7150	71	7662	56	8581	86	9851	94
1802	48	5613	98	6831	31	7191	90	7663	56	8651	93	9852	94
1803	48	5614	98	6832	31	7192	90	7681	61	8652	93	9932	97
1810	49	5615	99	6841	22	7241	64	7682	61	8653	93	9933	97
1820	49	5616	99	6842	22	7242	64	7683	61	8671	70	9952	97
1830	49	5617	99	6843	22	7251	92	7684	61	8672	70	9953	97
2000	104	5618	99	6851	24	7252	92	7691	54	8673	70	9991	97
2111	103	5619	99	6852	24	7281	70	7692	54	8701	71	9992	97
2112	103	5621	100	6853	24	7282	70	7693	54	8702	71	9993	97
2211	103	5622	100	6860	28	7291	70	7694	54	8711	71		
2212	103	5623	100	6861	28	7292	70	7751	53	8712	71		
2840	45	5624	100	6862	28	7321	65	7810	76	8721	75		
2850	45	5625	100	6863	28	7322	65	7811	76	8722	75		
2860	45	5626	101	6871	21	7371	91	7812	76	8731	72		
2880	89	5627	101	6872	21	7372	91	7813	76	8732	72		
3251	81	5628	101	6873	21	7421	87	7814	76	8800	65	ED-15	112
3252	81	5629	101	6880	14	7422	87	7830	92	8820	73	M-45	111
3261	80	6100	37	6881	14	7461	62	7861	67	8830	73	T-14	112
3262	81	6111	37	6882	14	7462	62	7861	78	8841	91	T-21	112
3271	82	6112	37	6883	14	7463	62	7862	67	8842	91	T-25	112
3272	82	6130	85	6884	14	7471	63	7862	78	8851	64	T-31	112
3281	68	6131	84	6891	20	7472	63	7921	77	8852	64	T-35	112
3282	68	6132	84	6892	20	7473	63	7922	77	8871	87	T-40	112
3500	69	6150	85	6893	20	7481	63	7923	77	8891	20	T-60	112
3510	69	6151	85	7000	76	7482	63	8010	74	8892	20	231	112
3511	69	6152	85	7001	76	7483	63	8080	62	8921	77	232	112

Tornillos y cerrres
Vis et fermetures
Screws and locks
Schrauben und
Druckverschlüsse

© J. José Vergés S.A., 2022

Avda. de Cornellá, 140 bajos
Edificio LEKLA
08950 Esplugues de Llobregat
Barcelona - Spain
Tel. Nacional 933 713 954*
Fax Nacional 933 725 302
International Tel. 34 933 713 958*
International Fax 34 933 725 302
Email: estamp@verges.com
www.verges.com

Los acabados mostrados
en este catálogo
son aproximados e
ilustrativos y pueden
variar ligeramente del
color real.

Les finitions montrées
dans ce catalogue sont
approximées et illustratives
et elles peuvent varier
légèrement de la couleur
réelle.

The finishes displayed
in this catalogue are
approximate and may vary
slightly from the actual
colour.

Die in diesem Katalog
gezeigten Oberflächen
sind ungefähre Angaben
und können von der
tatsächlichen Farbe
abweichen.

95 años de continua evolución

95 ans de continue évolution

95 years in constant evolution

95 Jahre kontinuierlicher Evolution

En Estamp cumplimos 95 años. Casi un siglo en el que hemos fabricado y vendido millones de artículos en todo el mundo.

Nada de esto hubiera sido posible sin la inestimable cooperación de todos y cada uno de nuestros colaboradores, dentro y fuera de nuestra empresa. Tampoco sin la creatividad y el acierto de nuestros diseñadores y la colaboración de nuestros proveedores. Es por eso que hoy queremos agradecer a todos ellos que nos hayan acompañado durante este largo viaje, e invitarles a que sigan haciéndolo durante muchos más.

Chez Estamp, nous avons 95 ans. Presque un siècle dans lequel nous avons fabriqué et vendu millions d'articles dans le monde entier.

Rien de cela aurait été possible sans l'inestimable coopération de tous et chacun de nos collaborateurs, dans et hors de notre entreprise. Aussi sans la créativité et le succès de nos designers et avec la collaboration de nos fournisseurs. C'est pour cela qu'aujourd'hui nous voulons remercier à tous ceux qui nous ont accompagnés pendant ce long voyage et les inviter à continuer de le faire pendant beaucoup plus.

At Estamp we celebrate our 95th birthday. Nearly a century during which we have manufactured and sold millions of articles worldwide.

This would not have been possible without the valueless co-operation of each and every one of our teammates, inside and outside our company. Nor without the creativity and the success of our designers and the co-operation of our suppliers. So today we wish to thank them all for walking beside us during this long journey, and to invite them to go on doing so for may more years to come.

Bei Estamp feiern wir 95 jähriges Jubiläum. Fast ein Jahrhundert, in dem wir Millionen Artikel hergestellt und weltweit verkauft haben.

All dies wäre nicht möglich gewesen ohne die unschätzbare Zusammenarbeit mit jedem einzelnen Mitarbeiter, innerhalb und außerhalb unseres Unternehmens, und überdies der Kreativität und dem Geschick unserer Designer sowie der Beteiligung unserer Lieferanten. Deshalb möchten wir uns heute bei allen bedanken, die uns auf dieser langen Reise begleitet haben und Sie einladen, dies noch für viele weitere Jahre zu tun.



Calidad y perfección Qualité et perfection Quality and perfection Qualität und Perfektion

La calidad y perfección siempre han sido nuestra divisa y la clave de nuestro éxito, por eso la hemos hecho extensiva a todos nuestros ámbitos de actividad, tanto de producción como humanos.

La qualité et la perfection ont été toujours notre devise et la clé de notre succès, pour cela nous l'avons étendu à tous nos cadres d'activité tant en production comme humains.

Quality and perfection have always been our trademark and the key to our success. This is why we have extended them to all our areas of activity, as much in production as in human resources.

Qualität und Perfektion sind seit jeher unser Motto und der Schlüssel unseres Erfolges. Aus diesem Grund haben wir es auf alle Tätigkeitsbereiche ausgedehnt, sowohl in der Produktion als auch das Personal betreffend.



Spheres



Empeño en la perfección

L'Effort de la perfection

Endeavor for perfection

Das Bekenntnis zur Perfektion



Tecnología, Experiencia y Talento

Technologie, Expérience et Talent

Technology, Expertise and Talent

Technologie, Erfahrung und Talent

Tres elementos imprescindibles para concebir y producir más de 1.500 artículos de formas puras de alta calidad y acabados perfectos.

Trois éléments indispensables pour concevoir et produire plus de 1.500 articles de formes pures de haute qualité et de finitions parfaites.

Three essential elements to conceive and produce more than 1.500 articles in pure forms of high quality and perfect finishes.

Drei wesentliche Elemente zur Schaffung und Herstellung von mehr als 1.500 Artikeln reiner Formen in hoher Qualität und mit perfekten Oberflächen.



Diseño creativo

Design créatif
Creative design
Kreatives Design



Swing
Balutto Associati



Balutto Associati

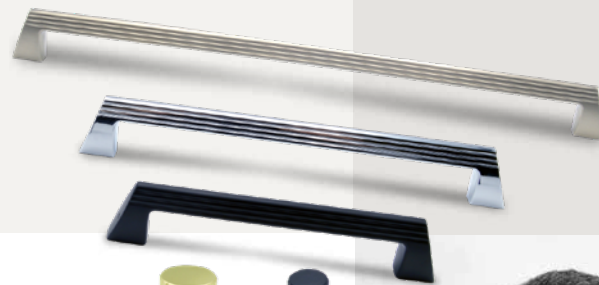

ProFit
Josep J. Teruel



Grooves
Ramón Segarra



Ramón Segarra



Josep J. Teruel

Creando tendencias

En créant des tendances
Creating trends
Trends setzen

Afamosos y experimentados diseñadores, innovan día a día para crear piezas únicas y nuevas colecciones.

Renommés et expérimentés designers innoverent jour à jour pour créer de pièces uniques et de nouvelles collections.

Renowned and experienced designers innovate every day to create unique pieces and new collections.

Renommierter und erfahrene Designer innovieren Tag für Tag, um einzigartige Stücke und neue Kollektionen zu kreieren.



Laps
Jorge Navarro



Jorge Navarro

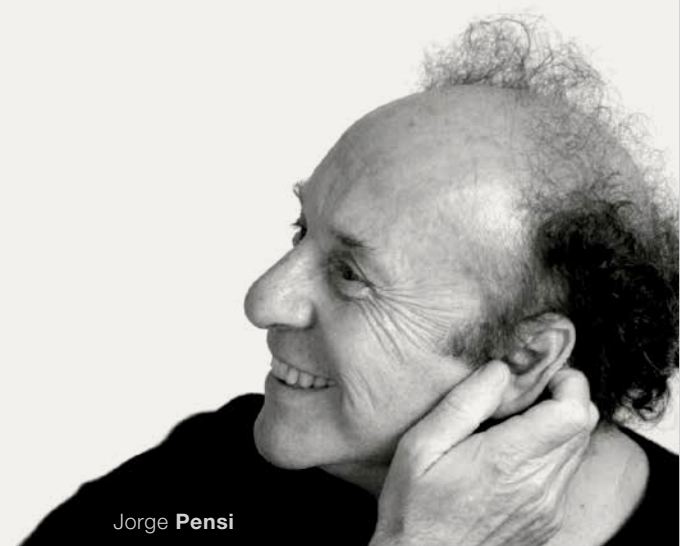

Jorge Pensi



Circle
Jorge Pensi Design Studio

innovazione

El medio ambiente: nuestro compromiso

L'environnement : notre objectif

Environment is our aim

Umweltschutz: unser Ziel

En Estamp estamos plenamente comprometidos con la conservación del medio ambiente y es por eso que fuimos de las primeras empresas de nuestro sector en obtener la certificación ISO 14001 que nos acredita como fabricantes que utilizan procesos productivos no contaminantes y es también por eso que nos aseguramos que nuestros productos se fabriquen utilizando materiales que, como en el caso de la madera, permitan la sostenibilidad de los recursos naturales de nuestro planeta.

Chez Estamp, nous sommes pleinement engagés dans la préservation de l'environnement et pour cette raison, nous avons été l'une des premières entreprises de notre secteur à obtenir la certification ISO 14001 qui nous accrédite comme fabricants qui utilisent des processus de production non polluants. Nous veillons à ce que nos produits soient fabriqués en utilisant des matériaux qui, comme dans le cas du bois, permettent la durabilité des ressources naturelles de notre planète.

At Estamp we are fully committed to environmental sustainability and this is the reason why we were among the first companies in our sector to obtain the ISO 14001 certification that attests us as manufacturers using non-polluting production processes. This is also why we ensure that our products are manufactured using materials that, as in the case of wood, allow for the sustainability of our planet's natural resources.

Bei Estamp setzen wir uns voll und ganz für den Umweltschutz ein. Deshalb haben wir als eines der ersten Unternehmen unserer Branche die ISO 14001-Zertifizierung erhalten, die uns als Hersteller mit umweltfreundlichen Produktionsprozessen ausweist. Wir achten darauf, dass unsere Produkte aus Materialien wie beispielsweise Holz hergestellt werden, die Nachhaltigkeitsanforderungen erfüllen.

Protegiendo nuestro mundo

En protégeant notre monde

Protecting our world

Schutz unserer Umwelt

Expertos en fabricar con la mejor calidad y el máximo respeto al medioambiente.

Experts dans la fabrication avec la plus haute qualité et maximum de respect pour l'environnement.

Experts in manufacturing with the highest quality and maximum respect for the environment.

Experten bei der Herstellung in hochwertiger Qualität und maximalem Respekt für die Umwelt.

Timber

Round

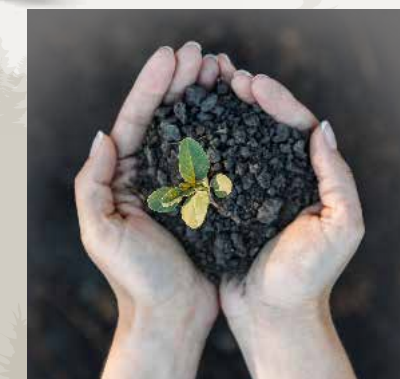

Conectados con nuestros clientes

Connecté avec nos clients

Connected with our clients

Verbunden mit unseren Kunden

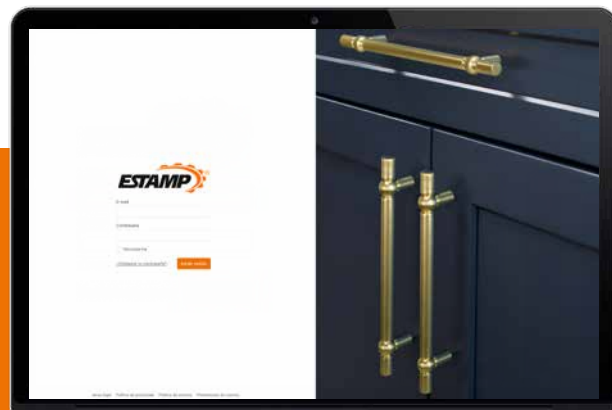

Descubra las últimas novedades
 Découvrez les dernières nouvelles
 Discover the latest news
 Entdecken Sie die neuesten Nachrichten
www.verges.com



Marketing y Merchandising

Marketing et Merchandising

Marketing and Merchandising
 Marketing und Merchandising

En Estamp disponemos de un amplio equipo profesional dedicado al trato con el distribuidor para asesorarle de las mejores opciones comerciales para su punto de venta. Ponemos a su alcance una amplia variedad de herramientas que le ayudarán a conocer y, a la vez, dar a conocer mejor nuestros productos.

Chez Estamp, nous disposons d'une large équipe professionnelle dédiée au traitement avec le distributeur pour leur conseiller les meilleures options commerciales pour leur point de vente. Nous avons à leur disposition une vaste variété d'outils qui leur aideront à connaître et en même temps, donner à connaître mieux nos produits.

At Estamp we have a large professional team dedicated to deal with the distributor, to advise them of the best commercial options for their point of sale. We put at their disposal a wide variety of tools that will help you to know our product and, at the same time, make it better known.

Bei Estamp haben wir ein vielfgestaltetes Team, das mit den Vertreibern in Verbindung steht. Es berät sie über die beste kommerzielle Option für Ihre Verkaufsabteilung. Ihnen steht eine breitgefächerte Vielfalt an Instrumenten zur Verfügung, die Ihnen helfen, unsere Produkte besser kennen zu lernen und gleichzeitig bekannter zu machen.



38,5 x 50 cm
 40 x 90 cm

49 x 201 cm



Fluted

Zamak	B	C	D
6880	56	14	34

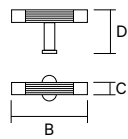

Fluted

Zamak	A	E	B	C	D
6881	2 x 491	982	1040	14	34
6882	480		538	14	34
6883	320		378	14	34
6884	192		250	14	34

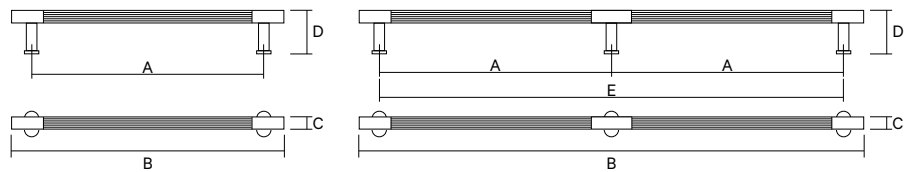

Acabado / Finition / Finish / Oberfläche



220

Oro cepillado anodizado
Or brossé anodisé
Brushed gold anodized
Goldfarben gebürstet eloxiert



232

Negro mate anodizado
Noir mat anodisé
Dull black anodized
Schwarz matt eloxiert



238

Níquel cepillado anodizado
Nickelé brossé anodisé
Brushed nickel anodized
Vernickelt gebürstet eloxiert



Otras longitudes disponibles bajo demanda y sujetas a cantidades mínimas a consultar.
Autres longueurs disponibles sur demande et sous réserve de quantités minimales à consulter.
Other lengths available and subject to minimum quantities on request.
Andere Längen auf Anfrage erhältlich, vorbehaltlich Mindestmengen.

Timber

Madera / Bois / Wood / Holz

	A	E	B	C	D
9411	3 x 352	1056	1110	24	12
9412	320		400	24	12
9413	192		250	24	12
9414	32		60	24	12

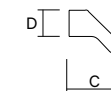
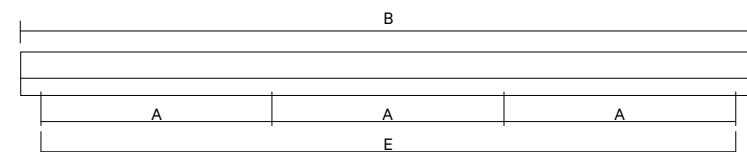
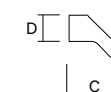
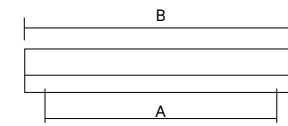

Acabado / Finition / Finish / Oberfläche



017

Arce barniz natural
Érable vernis naturel
Maple clear varnished
Ahorn klar lackiert



046

Arce barniz wengué
Érable vernis wengué
Maple wenge varnished
Ahorn wenge lackiert



Round

Zamak - Madera / Bois / Wood / Holz

	B	C	D
9400	68	15	34

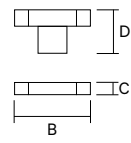

Round

Zamak - Madera / Bois / Wood / Holz

	A	E	B	C	D
9401	2 x 480	960	996	15	34
9402	480		516	15	34
9403	320		356	15	34
9404	192		228	15	34
9405	160		196	15	34

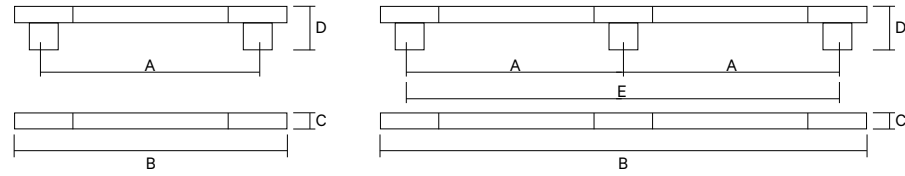

Acabado / Finition / Finish / Oberfläche



217

Oro cepillado arce barniz natural
Or brossé érable vernis naturel
Brushed gold, maple clear varnished
Goldfarben gebürstet, Ahorn klar lackiert



246

Oro cepillado arce barniz wengué
Or brossé érable vernis wengué
Brushed gold, maple wenge varnished
Goldfarben gebürstet, Ahorn wenge lackiert



317

Niquel cepillado arce barniz natural
Nickelé brossé érable vernis naturel
Brushed nickel, maple clear varnished
Vernickelt gebürstet, Ahorn klar lackiert



346

Niquel cepillado arce barniz wengué
Nickelé brossé érable vernis wengué
Brushed nickel, maple wenge varnished
Vernickelt gebürstet, Ahorn wenge lackiert



617

Negro mate arce barniz natural
Noir mat érable vernis naturel
Dull black, maple clear varnished
Schwarz matt, Ahorn klar lackiert



646

Negro mate arce barniz wengué
Noir mat érable vernis wengué
Dull black, maple wenge varnished
Schwarz matt, Ahorn wenge lackiert

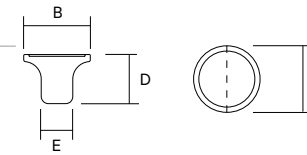

Forest

Madera / Bois / Wood / Holz

	B	D	E
9011	38	28	18
9012	30	25	14

Acabado / Finition / Finish / Oberfläche



011

Madera barniz natural
Bois vernis naturel
Wood clear varnished
Holz klar lackiert



049

Madera barniz wengué
Bois vernis wengué
Wood wenge varnished
Holz wenge lackiert



Slot

Aluminio / Aluminium / Aluminium / Aluminium

	A	E	B	C	D
6601	3 x 352	1056	1110	42	17
6602	320		400	42	17
6603	192		250	42	17
6604	32		50	42	17

Acabado / Finition / Finish / Oberfläche



220

Oro cepillado anodizado
Or brossé anodisé
Brushed gold anodized
Goldfarben gebürstet eloxiert



232

Negro mate anodizado
Noir mat anodisé
Dull black anodized
Schwarz matt eloxiert



238

Níquel cepillado anodizado
Nickelé brossé anodisé
Brushed nickel anodized
Vernickelt gebürstet eloxiert

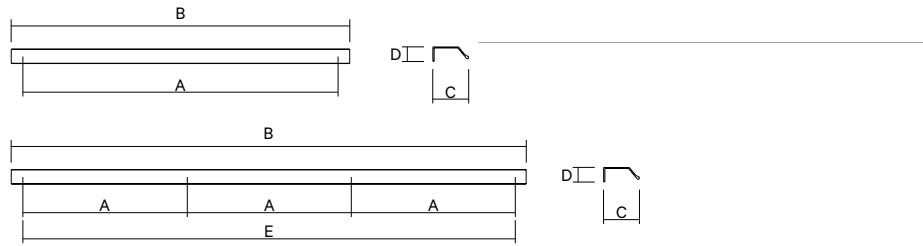

Flat

Aluminio / Aluminium / Aluminium / Aluminium

	A	B	B	C	D
6611	3 x 352	1056	1110	40	17
6612	320		400	40	17
6613	192		250	40	17
6614	32		50	40	17

Acabado / Finition / Finish / Oberfläche



220

Oro cepillado anodizado
Or brossé anodisé
Brushed gold anodized
Goldfarben gebürstet eloxiert



232

Negro mate anodizado
Noir mat anodisé
Dull black anodized
Schwarz matt eloxiert



238

Níquel cepillado anodizado
Nickelé brossé anodisé
Brushed nickel anodized
Vernickelt gebürstet eloxiert

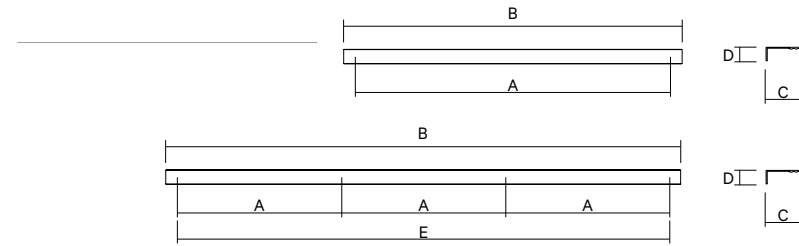

Mesh

Aluminio / Aluminium / Aluminium / Aluminium

	B	D	E
8891	36	28	20
8892	26	23	12

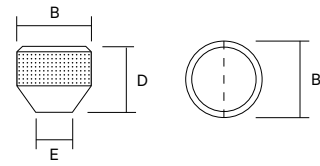

Mesh

Aluminio / Aluminium / Aluminium / Aluminium

	A	B	C	D
6891	320	332	12	29,5
6892	192	204	12	29,5
6893	160	172	12	29,5

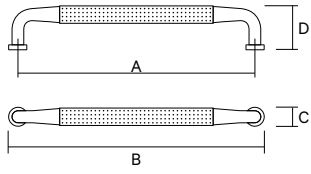

Acabado / Finition / Finish / Oberfläche



220

Oro cepillado anodizado
Or brossé anodisé
Brushed gold anodized
Goldfarben gebürstet eloxiert



232

Negro mate anodizado
Noir mat anodisé
Dull black anodized
Schwarz matt eloxiert



238

Níquel cepillado anodizado
Nickelé brossé anodisé
Brushed nickel anodized
Vernickelt gebürstet eloxiert



Grooves

Zamak

	B	D
8181	28	30
8182	18	28

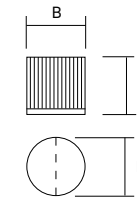

Grooves

Zamak

	A	B	C	D
6871	320	338	9	30
6872	192	210	9	30
6873	128	146	9	30

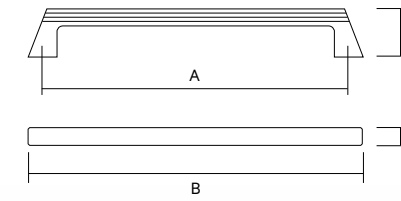

Acabado / Finition / Finish / Oberfläche



020

Oro cepillado
Or brossé
Brushed Gold
Gebürstetes Gold



032

Negro mate
Noir mat
Dull black
Mattschwarz



038

Níquel cepillado
Nickelé brossé
Brushed Nickel
Gebürstetes Nickel



400

Cromo brillo
Chromé brillant
Bright chrome
Glänzend verchromt

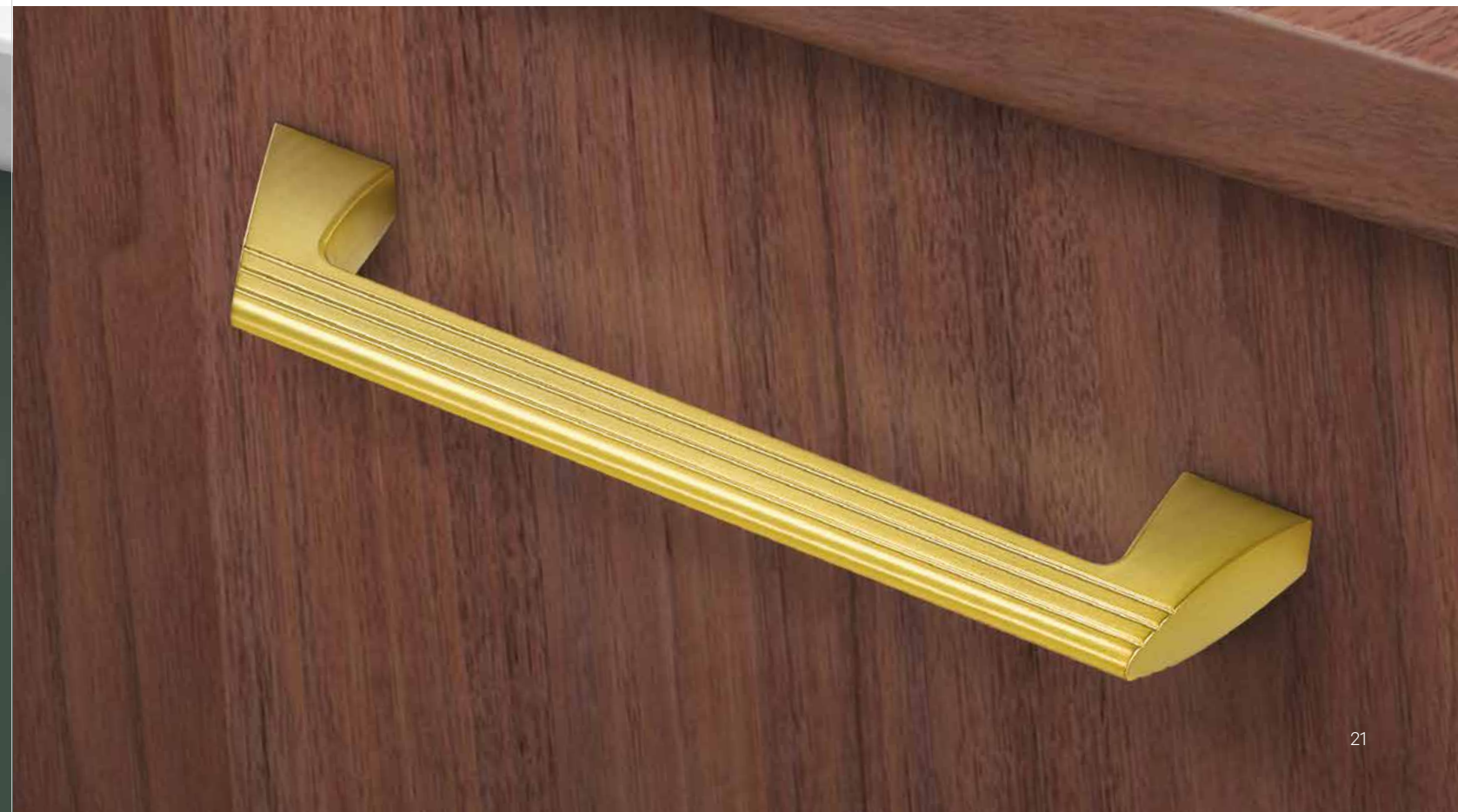

Disc

Zamak			
	B	D	E
8341	33	25	15
8342	28	23	18

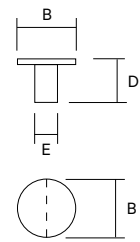

Right

Zamak				
	A	B	C	D
6841	320	360	8	28
6842	192	232	8	28
6843	128	168	8	28

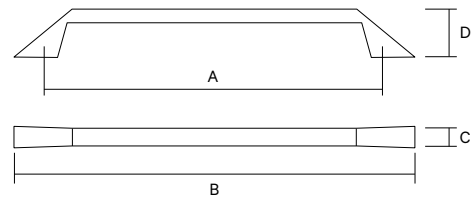

Acabado / Finition / Finish / Oberfläche



020
Oro cepillado
Or brossé
Brushed Gold
Gebürstetes Gold



032
Negro mate
Noir mat
Dull black
Mattschwarz



038
Níquel cepillado
Nickelé brossé
Brushed Nickel
Gebürstetes Nickel



292
Blanco mate
Blanc mat
Dull white
Matt Weiß

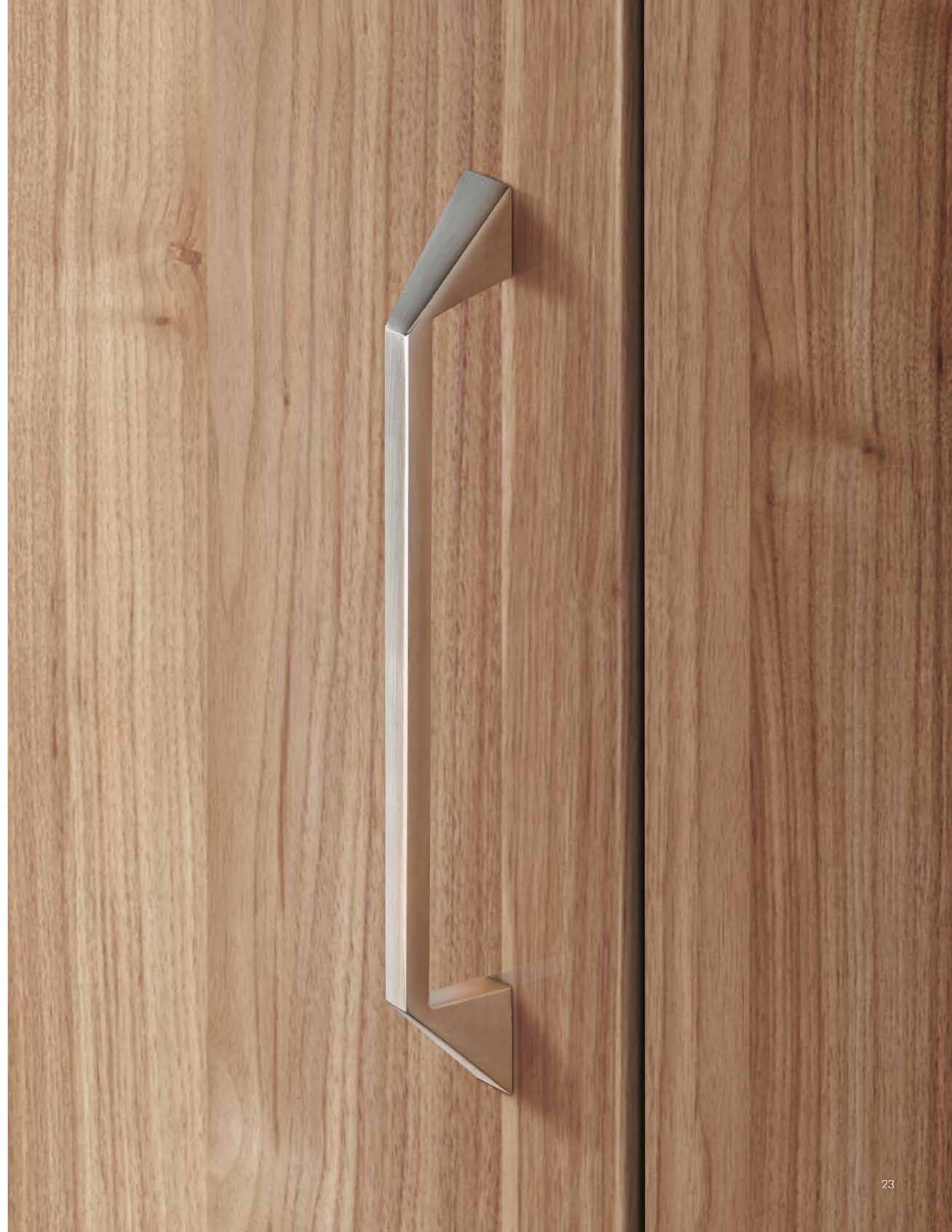

Wedge

Zamak

	A	B	C	D
6851	320	338	18	28
6852	192	210	18	28
6853	128	146	18	28

Acabado / Finition / Finish / Oberfläche



020
Oro cepillado
Or brossé
Brushed Gold
Gebürstetes Gold



032
Negro mate
Noir mat
Dull black
Mattschwarz



038
Níquel cepillado
Nickelé brossé
Brushed Nickel
Gebürstetes Nickel



292
Blanco mate
Blanc mat
Dull white
Matt Weiß

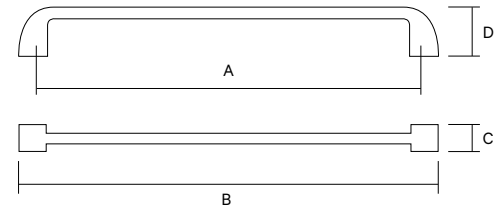

Swing

Zamak	B	C	D
6242	55	44	24

Acabado / Finition / Finish / Oberfläche

		
020 Oro cepillado Or brossé Brushed Gold Gebürstetes Gold	038 Níquel cepillado Nickelé brossé Brushed Nickel Gebürstetes Nickel	831 Bronce rústico Bronze rustique Antique brass Bronze rustikal

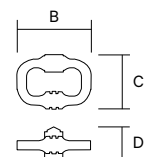

Swing

Zamak	A	B	C	D
6241	64	120	44	24

Acabado / Finition / Finish / Oberfläche

		
020 Oro cepillado Or brossé Brushed Gold Gebürstetes Gold	038 Níquel cepillado Nickelé brossé Brushed Nickel Gebürstetes Nickel	831 Bronce rústico Bronze rustique Antique brass Bronze rustikal

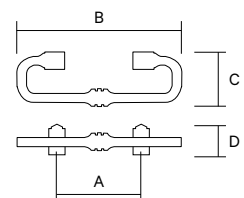

Swing

Zamak	A	B	C	D
6240	160	184	24	34

Acabado / Finition / Finish / Oberfläche

		
020 Oro cepillado Or brossé Brushed Gold Gebürstetes Gold	038 Níquel cepillado Nickelé brossé Brushed Nickel Gebürstetes Nickel	831 Bronce rústico Bronze rustique Antique brass Bronze rustikal

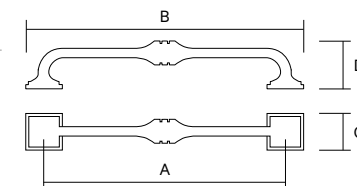

Spheres

Zamak

	B	C	D
6860	46	14	30

Spheres

Zamak

	A	B	C	D
6861	192	238	14	30
6862	128	174	14	30
6863	96	142	14	30

Acabado / Finition / Finish / Oberfläche



020
Oro cepillado
Or brossé
Brushed Gold
Gebürstetes Gold



032
Negro mate
Noir mat
Dull black
Mattschwarz



038
Níquel cepillado
Nickelé brossé
Brushed Nickel
Gebürstetes Nickel



831
Bronze rústico
Bronze rustique
Antique brass
Bronze rustikal

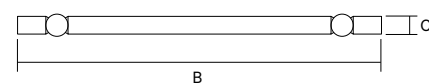
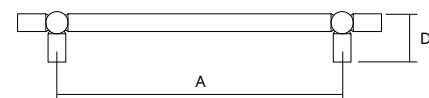
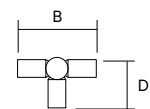

Shell

Zamak	A	B	C	D
3961	64	101	26	29

Acabado / Finition / Finish / Oberfläche



020
Oro cepillado
Or brossé
Brushed Gold
Gebürstetes Gold



032
Negro mate
Noir mat
Dull black
Mattschwarz



038
Níquel cepillado
Nickelé brossé
Brushed Nickel
Gebürstetes Nickel



400
Cromo brillo
Chromé brillant
Bright chrome
Glänzend verchromt

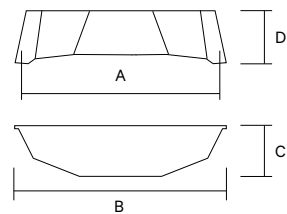

Post

Zamak	A	B	C	D
6831	192	213	31	20
6832	128	149	31	20

Acabado / Finition / Finish / Oberfläche



020
Oro cepillado
Or brossé
Brushed Gold
Gebürstetes Gold



032
Negro mate
Noir mat
Dull black
Mattschwarz



038
Níquel cepillado
Nickelé brossé
Brushed Nickel
Gebürstetes Nickel



250
Oro mate
Or mat
Dull gold
Matt Gold



292
Blanco mate
Blanc mat
Dull white
Matt Weiß



400
Cromo brillo
Chromé brillant
Bright chrome
Glänzend verchromt



750
Grafito
Graphite
Graphite
Graphit



800
Cromo mate
Chromé mat
Dull chrome
Matt verchromt

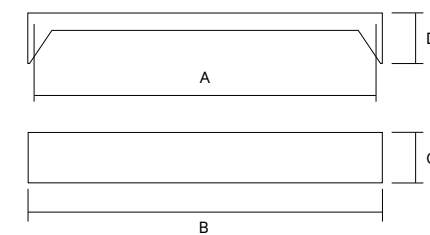

Fluid

Zamak

	A	B	C	D
6821	320/288	363	7,60/12,80	33,80
6822	224/192	263	7,60/12,80	28,80

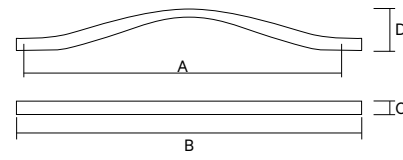

Acabado / Finition / Finish / Oberfläche



020 Oro cepillado
Or brossé
Brushed Gold
Gebürstetes Gold

032 Negro mate
Noir mat
Dull black
Mattschwarz

038 Níquel cepillado
Nickelé brossé
Brushed Nickel
Gebürstetes Nickel

250 Oro mate
Or mat
Dull gold
Matt Gold



292 Blanco mate
Blanc mat
Dull white
Matt Weiß

400 Cromo brillo
Chromé brillant
Bright chrome
Glänzend verchromt

750 Grafito
Graphite
Graphite
Graphit

800 Cromo mate
Chromé mat
Dull chrome
Matt verchromt

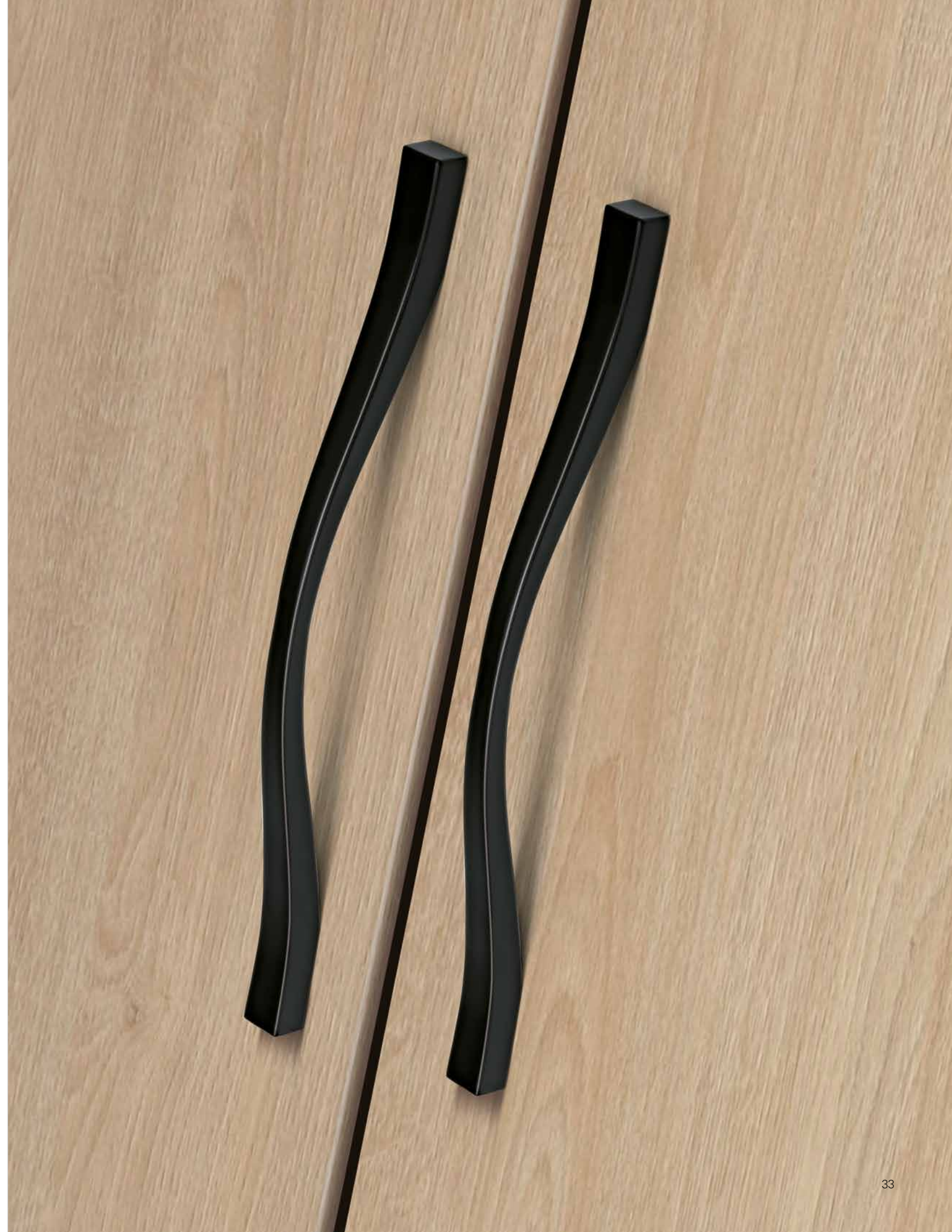

Round

Zamak	D	E	F
3760	70	45	11

Acabado / Finition / Finish / Oberfläche



032
Negro mate
Noir mat
Dull black
Mattschwarz



038
Niquel cepillado
Nickelé brossé
Brushed Nickel
Gebürstetes Nickel



292
Blanco mate
Blanc mat
Dull white
Matt Weiß



400
Cromo brillo
Chromé brillant
Bright chrome
Glänzend verchromt

Square

Zamak	B	C	E	F
3770	73	73	45	11

Acabado / Finition / Finish / Oberfläche



032
Negro mate
Noir mat
Dull black
Mattschwarz



038
Niquel cepillado
Nickelé brossé
Brushed Nickel
Gebürstetes Nickel



292
Blanco mate
Blanc mat
Dull white
Matt Weiß



400
Cromo brillo
Chromé brillant
Bright chrome
Glänzend verchromt

Oval

Zamak	B	C	E	F
3780	155	70	40x123	11

Acabado / Finition / Finish / Oberfläche



032
Negro mate
Noir mat
Dull black
Mattschwarz



038
Niquel cepillado
Nickelé brossé
Brushed Nickel
Gebürstetes Nickel



292
Blanco mate
Blanc mat
Dull white
Matt Weiß



400
Cromo brillo
Chromé brillant
Bright chrome
Glänzend verchromt

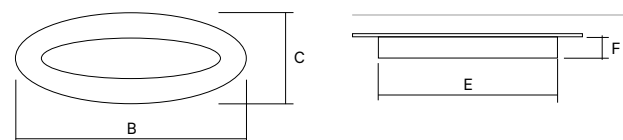
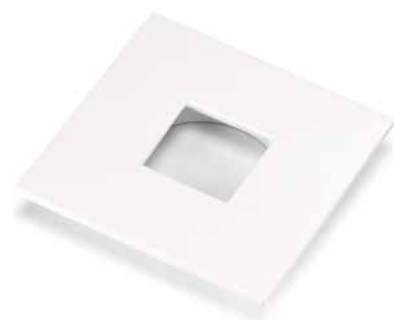
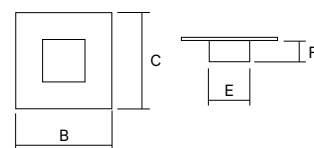
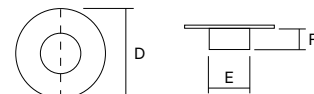

Rectangular

Zamak	B	C	E	F
3790	155	73	40x123	11

Acabado / Finition / Finish / Oberfläche



032
Negro mate
Noir mat
Dull black
Mattschwarz



038
Niquel cepillado
Nickelé brossé
Brushed Nickel
Gebürstetes Nickel



292
Blanco mate
Blanc mat
Dull white
Matt Weiß



400
Cromo brillo
Chromé brillant
Bright chrome
Glänzend verchromt

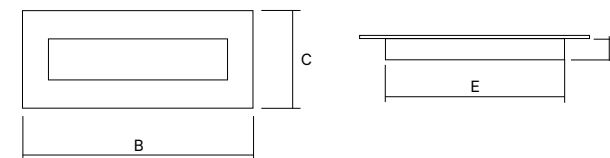

Elbow

Zamak	A	B	C	D
6231	192	208	20	30
6232	128	144	20	30

Acabado / Finition / Finish / Oberfläche



032
Negro mate
Noir mat
Dull black
Mattschwarz



038
Níquel cepillado
Nickelé brossé
Brushed Nickel
Gebürstetes Nickel



292
Blanco mate
Blanc mat
Dull white
Matt Weiß

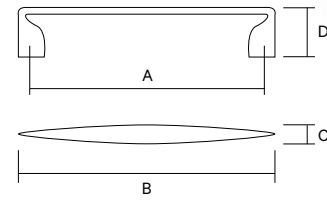

Scoop

Zamak	A	B	C	D
6801	224	320	45,5	18
6802	160	240	45,5	18
6803	32	72	45,5	18

Acabado / Finition / Finish / Oberfläche



038
Níquel cepillado
Nickelé brossé
Brushed Nickel
Gebürstetes Nickel



400
Cromo brillo
Chromé brillant
Bright chrome
Glänzend verchromt



800
Cromo mate
Chromé mat
Dull chrome
Matt verchromt

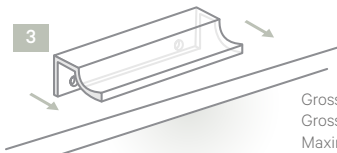
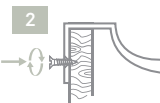
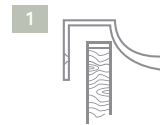
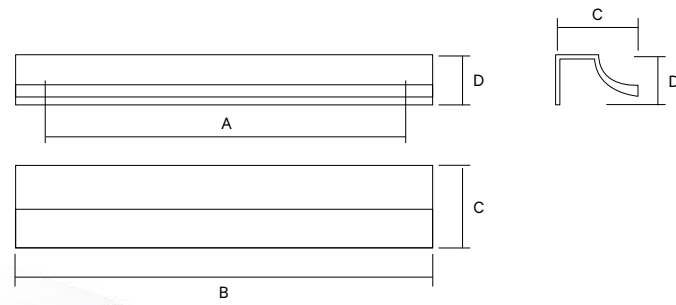

Grossor máximo frontal cajón: 22 mm
Grosseur maximale frontal tirair: 22 mm
Maximum width drawer front: 22 mm
Dicke maximal front schublade: 22 mm

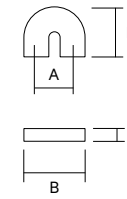

Circle

Zamak	A	B	C	D
6100	32	40	11	28

Acabado / Finition / Finish / Oberfläche



032
Negro mate
Noir mat
Dull black
Mattschwarz



038
Níquel cepillado
Nickelé brossé
Brushed Nickel
Gebürstetes Nickel



292
Blanco mate
Blanc mat
Dull white
Matt Weiß



400
Cromo brillo
Chromé brillant
Bright chrome
Glänzend verchromt



800
Cromo mate
Chromé mat
Dull chrome
Matt verchromt

Circle

Zamak	A	B	C	D
6111	32	40	8	40
6112		25	8	27

Acabado / Finition / Finish / Oberfläche



032
Negro mate
Noir mat
Dull black
Mattschwarz



038
Níquel cepillado
Nickelé brossé
Brushed Nickel
Gebürstetes Nickel



292
Blanco mate
Blanc mat
Dull white
Matt Weiß



400
Cromo brillo
Chromé brillant
Bright chrome
Glänzend verchromt



800
Cromo mate
Chromé mat
Dull chrome
Matt verchromt

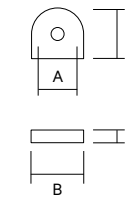

Flexo

Zamak

	A	B	C	D
6191	160	186	24	29

Acabado / Finition / Finish / Oberfläche



811

Bronce Industrial
Bronze industriel
Industrial Bronze
Bronze industriell



812

Hierro Industrial
Fer industriel
Industrial Iron
Eisen industriell

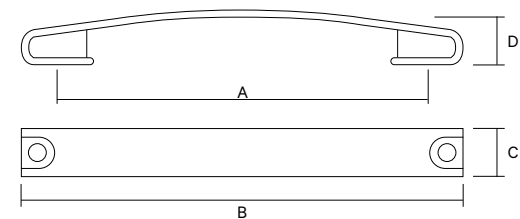

Flexo

Zamak

	B	C	D
6190	49	24	25

Acabado / Finition / Finish / Oberfläche



811

Bronce Industrial
Bronze industriel
Industrial Bronze
Bronze industriell



812

Hierro Industrial
Fer industriel
Industrial Iron
Eisen industriell

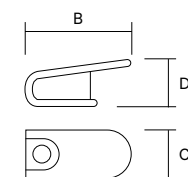

Tube

Zamak

	A	B	C	D
6201	192	212	14	34

Acabado / Finition / Finish / Oberfläche



831

Bronce rústico
Bronze rustique
Antique brass
Bronze rustikal



836

Estaño rústico
Etain rustique
Rustic tin
Zinn rustikal

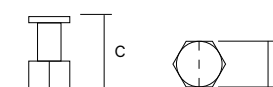
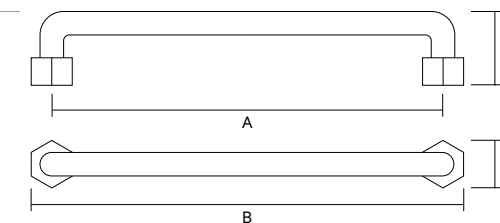

Tube

Zamak

	C	D
6200	33	19

Acabado / Finition / Finish / Oberfläche



831

Bronce rústico
Bronze rustique
Antique brass
Bronze rustikal



836

Estaño rústico
Etain rustique
Rustic tin
Zinn rustikal

Rivet

Zamak	A	B	C	D
6211	160	186	22	28

Acabado / Finition / Finish / Oberfläche



811

Bronze Industrial
Bronze industriel
Industrial Bronze
Bronze industriell



812

Hierro Industrial
Fer industriel
Industrial Iron
Eisen industriell

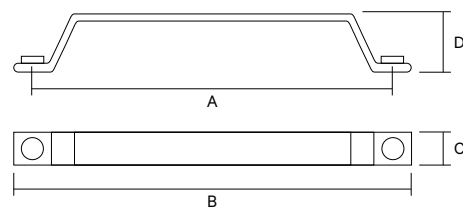

Rivet

Zamak	B	C	D
6210	56	20	30

Acabado / Finition / Finish / Oberfläche



811

Bronze Industrial
Bronze industriel
Industrial Bronze
Bronze industriell



812

Hierro Industrial
Fer industriel
Industrial Iron
Eisen industriell

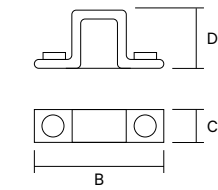

Arch

Zamak	A	B	C	D
6791	192	270	20	20
6792	128	206	20	20

Acabado / Finition / Finish / Oberfläche



032

Negro mate
Noir mat
Dull black
Mattschwarz



038

Níquel cepillado
Nickelé brossé
Brushed Nickel
Gebürstetes Nickel



292

Blanco mate
Blanc mat
Dull white
Matt Weiß



800

Cromo mate
Chromé mat
Dull chrome
Matt verchromt

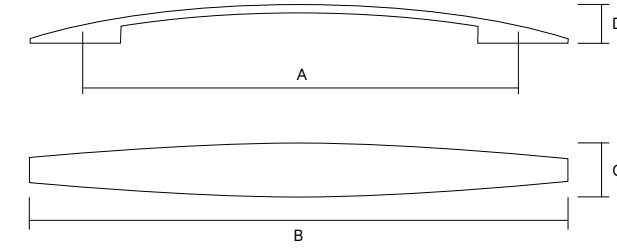







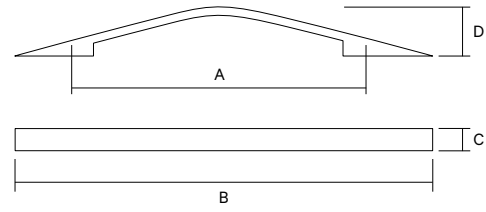

Fuji

Zamak

	A	B	C	D
6811	224	320	20	32
6812	160	230	20	32



Acabado / Finition / Finish / Oberfläche

					
020 Oro cepillado Or brossé Brushed Gold Gebürstetes Gold	032 Negro mate Noir mat Dull black Mattschwarz	038 Níquel cepillado Nickelé brossé Brushed Nickel Gebürstetes Nickel	250 Oro mate Or mat Dull gold Matt Gold	292 Blanco mate Blanc mat Dull white Matt Weiß	400 Cromo brillo Chromé brillant Bright chrome Glänzend verchromt
					
750 Grafito Graphite Graphit	800 Cromo mate Chromé mat Dull chrome Matt verchromt	808 Cobre rústico Cuivre rustique Rustic copper Kupfer rustikal	831 Bronce rústico Bronze rustique Antique brass Bronze rustikal	836 Estaño rústico Etain rustique Rustic tin Zinn rustikal	









Lips

Zamak

	A	B	C	D
6781	224	320	45	21
6782	160	240	45	21

Acabado / Finition / Finish / Oberfläche

		
032 Negro mate Noir mat Dull black Mattschwarz	038 Níquel cepillado Nickelé brossé Brushed Nickel Gebürstetes Nickel	292 Blanco mate Blanc mat Dull white Matt Weiß
		
400 Cromo brillo Chromé brillant Bright chrome Glänzend verchromt	800 Cromo mate Chromé mat Dull chrome Matt verchromt	808 Cobre rústico Cuivre rustique Rustic copper Kupfer rustikal
		
831 Bronce rústico Bronze rustique Antique brass Bronze rustikal	836 Estaño rústico Etain rustique Rustic tin Zinn rustikal	

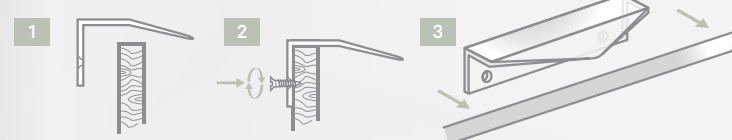
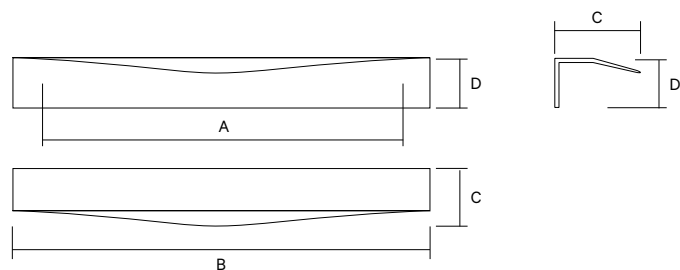



Grosor máximo frontal cajón: 24,5 mm
Grosueur maximale frontal tirair: 24,5 mm
Maximum width drawer front: 24,5 mm
Dicke maximal front schublade: 24,5 mm

Slide

Zamak

	B	C	D
2840	44	54	37

Acabado / Finition / Finish / Oberfläche

		
038 Níquel cepillado Nickelé brossé Brushed Nickel Gebürstetes Nickel	400 Cromo brillo Chromé brillant Bright chrome Glänzend verchromt	800 Cromo mate Chromé mat Dull chrome Matt verchromt

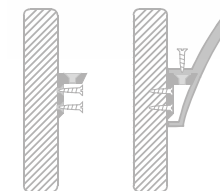
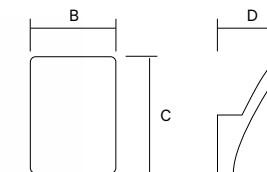

Los colgadores individuales poseen una efectiva y fácil manera de fijación.
Les portemanteaux individuels incorporent un système de fixation simple et efficace.
Individual hangers grant an easy and effective fixing system.
Die Einzelkleiderhaken verfügen über ein einfaches und wirksames Befestigungssystem.

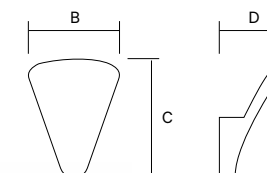

Slide

Zamak

	B	C	D
2850	49	55	37

Acabado / Finition / Finish / Oberfläche

		
038 Níquel cepillado Nickelé brossé Brushed Nickel Gebürstetes Nickel	400 Cromo brillo Chromé brillant Bright chrome Glänzend verchromt	800 Cromo mate Chromé mat Dull chrome Matt verchromt

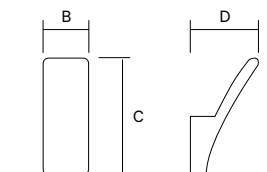

Slide

Zamak

	B	C	D
2860	25	56	30

Acabado / Finition / Finish / Oberfläche

		
038 Níquel cepillado Nickelé brossé Brushed Nickel Gebürstetes Nickel	400 Cromo brillo Chromé brillant Bright chrome Glänzend verchromt	800 Cromo mate Chromé mat Dull chrome Matt verchromt



Mini

Zamak

	B	C	D
8151	25	25	28
8152	15	15	24

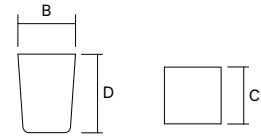

Acabado / Finition / Finish / Oberfläche



020
Oro cepillado
Or brossé
Brushed Gold
Gebürstetes Gold



021
Aluminio
Aluminium
Aluminium
Aluminium



038
Niquel cepillado
Nickelé brossé
Brushed Nickel
Gebürstetes Nickel



250
Oro mate
Or mat
Dull gold
Matt Gold



400
Cromo brillo
Chromé brillant
Bright chrome
Glänzend verchromt



750
Grafito
Graphite
Graphite
Graphit



800
Cromo mate
Chromé mat
Dull chrome
Matt verchromt



Mini

Zamak

	B	D
8161	25	28
8162	15	24

Acabado / Finition / Finish / Oberfläche



020
Oro cepillado
Or brossé
Brushed Gold
Gebürstetes Gold



021
Aluminio
Aluminium
Aluminium
Aluminium



032
Negro mate
Noir mat
Dull black
Mattschwarz



038
Niquel cepillado
Nickelé brossé
Brushed Nickel
Gebürstetes Nickel



250
Oro mate
Or mat
Dull gold
Matt Gold



800
Cromo mate
Chromé mat
Dull chrome
Matt verchromt



292
Blanco mate
Blanc mat
Dull white
Matt Weiß



400
Cromo brillo
Chromé brillant
Bright chrome
Glänzend verchromt



750
Grafito
Graphite
Graphite
Graphit



800
Cromo mate
Chromé mat
Dull chrome
Matt verchromt

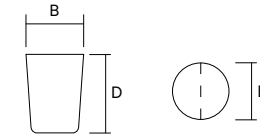

Mini

Zamak

	B	C	D
8171	34	14	28
8172	27	11	24

Acabado / Finition / Finish / Oberfläche



021
Aluminio
Aluminium
Aluminium
Aluminium



032
Negro mate
Noir mat
Dull black
Mattschwarz



038
Niquel cepillado
Nickelé brossé
Brushed Nickel
Gebürstetes Nickel



292
Blanco mate
Blanc mat
Dull white
Matt Weiß



400
Cromo brillo
Chromé brillant
Bright chrome
Glänzend verchromt



800
Cromo mate
Chromé mat
Dull chrome
Matt verchromt

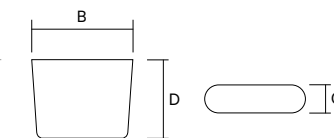

Profit

Zamak	A	B	C	D
1801	288/320	341	10	31
1802	192/224	245	10	31
1803	128/160	180	10	31

Acabado / Finition / Finish / Oberfläche



038

Níquel cepillado
Nickelé brossé
Brushed Nickel
Gebürstetes Nickel



800

Cromo mate
Chromé mat
Dull chrome
Matt verchromt

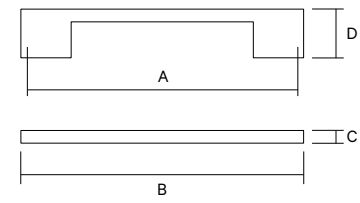

Proflex

Zamak	A	B	C	D
1810	192/224	247	26/10	32

Acabado / Finition / Finish / Oberfläche



038

Níquel cepillado
Nickelé brossé
Brushed Nickel
Gebürstetes Nickel



800

Cromo mate
Chromé mat
Dull chrome
Matt verchromt

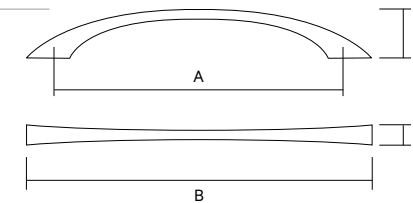

ProFlat

Zamak	A	B	C	D
1820	192/224	247	24/10	32

Acabado / Finition / Finish / Oberfläche



038

Níquel cepillado
Nickelé brossé
Brushed Nickel
Gebürstetes Nickel



800

Cromo mate
Chromé mat
Dull chrome
Matt verchromt

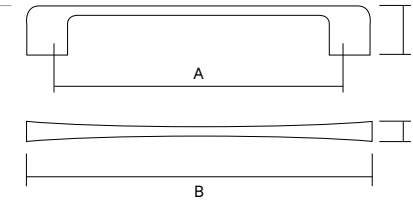

ProFab

Zamak	A	B	C	D
1830	192/224	247	20/11	31

Acabado / Finition / Finish / Oberfläche



038

Níquel cepillado
Nickelé brossé
Brushed Nickel
Gebürstetes Nickel



800

Cromo mate
Chromé mat
Dull chrome
Matt verchromt

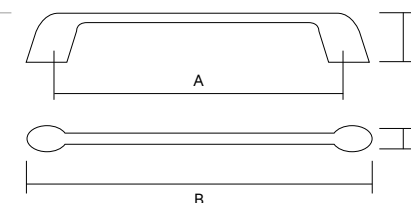







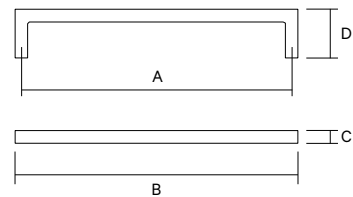

Basic

Zamak

	A	B	C	D
6761	320	328	8	28
6762	256	264	8	28
6763	192	200	8	28
6764	160	168	8	28
6765	128	136	8	28



Acabado / Finition / Finish / Oberfläche

				
020 Oro cepillado Or brossé Brushed Gold Gebürstetes Gold	032 Negro mate Noir mat Dull black Mattschwarz	038 Níquel cepillado Nickelé brossé Brushed Nickel Gebürstetes Nickel	250 Oro mate Or mat Dull gold Matt Gold	292 Blanco mate Blanc mat Dull white Matt Weiß
				
750 Grafito Graphite Graphit	800 Cromo mate Chromé mat Dull chrome Matt verchromt	808 Cobre rústico Cuivre rustique Rustic copper Kupfer rustikal	831 Bronce rústico Bronze rustique Antique brass Bronze rustikal	836 Estaño rústico Etain rustique Rustic tin Zinn rustikal



I-Spazio

Zamak	A	B	C	D	E	F	G
7570	192	260	8	32	22	108	130

Acabado / Finition / Finish / Oberfläche

021 Aluminio Aluminium Aluminium Aluminium	032 Negro mate Noir mat Dull black Mattschwarz	038 Níquel cepillado Nickelé brossé Brushed Nickel Gebürstetes Nickel
292 Blanco mate Blanc mat Dull white Matt Weiß	400 Cromo brillo Chromé brillant Bright chrome Glänzend verchromt	800 Cromo mate Chromé mat Dull chrome Matt verchromt

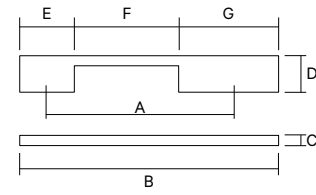

I-Spazio

Zamak	A	B	C	D	E	F	G
7571	192	260	8	32	76	108	76
7572	128	200	8	32	56	88	56

Acabado / Finition / Finish / Oberfläche

021 Aluminio Aluminium Aluminium Aluminium	032 Negro mate Noir mat Dull black Mattschwarz	038 Níquel cepillado Nickelé brossé Brushed Nickel Gebürstetes Nickel
292 Blanco mate Blanc mat Dull white Matt Weiß	400 Cromo brillo Chromé brillant Bright chrome Glänzend verchromt	800 Cromo mate Chromé mat Dull chrome Matt verchromt

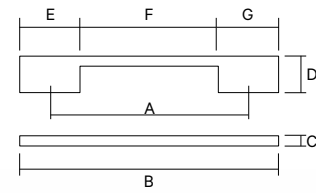

Edge

Zamak	A	B	C	D
7531	160	188	9	35
7532	96	124	8	30

Acabado / Finition / Finish / Oberfläche

021 Aluminio Aluminium Aluminium Aluminium	038 Níquel cepillado Nickelé brossé Brushed Nickel Gebürstetes Nickel	400 Cromo brillo Chromé brillant Bright chrome Glänzend verchromt	800 Cromo mate Chromé mat Dull chrome Matt verchromt

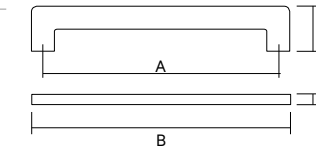

Jazz

Zamak	A	B	C	D
7751	160	204	25	29

Acabado / Finition / Finish / Oberfläche

021 Aluminio Aluminium Aluminium Aluminium	038 Níquel cepillado Nickelé brossé Brushed Nickel Gebürstetes Nickel	400 Cromo brillo Chromé brillant Bright chrome Glänzend verchromt	800 Cromo mate Chromé mat Dull chrome Matt verchromt

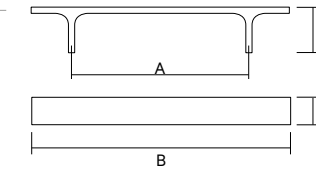

Dual

Zamak	A	B	C	D
7691	192	201	10	26
7692	160	169	10	26
7693	128	137	10	26

Acabado / Finition / Finish / Oberfläche



038
Níquel cepillado
Nickelé brossé
Brushed Nickel
Gebürstetes Nickel



400
Cromo brillo
Chromé brillant
Bright chrome
Glänzend verchromt



800
Cromo mate
Chromé mat
Dull chrome
Matt verchromt

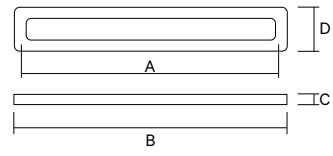

Dual

Zamak	A	B	C	D
7694	16	26	10	26

Acabado / Finition / Finish / Oberfläche



038
Níquel cepillado
Nickelé brossé
Brushed Nickel
Gebürstetes Nickel



400
Cromo brillo
Chromé brillant
Bright chrome
Glänzend verchromt



800
Cromo mate
Chromé mat
Dull chrome
Matt verchromt

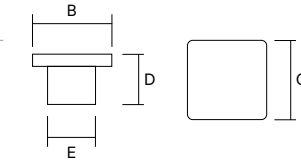
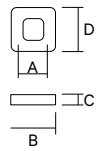

Wave

Zamak	B	C	D	E
8101	80	80	24	18
8102	50	50	24	16
8103	32	32	24	12

Acabado / Finition / Finish / Oberfläche



021
Aluminio
Aluminium
Aluminium



038
Níquel cepillado
Nickelé brossé
Brushed Nickel
Gebürstetes Nickel



400
Cromo brillo
Chromé brillant
Bright chrome
Glänzend verchromt



800
Cromo mate
Chromé mat
Dull chrome
Matt verchromt

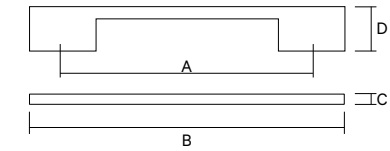

Align

Zamak	A	B	C	D
7541	224	252	9	20
7542	192	208	9	20
7543	128	157	9	20

Acabado / Finition / Finish / Oberfläche



021
Aluminio
Aluminium
Aluminium



038
Níquel cepillado
Nickelé brossé
Brushed Nickel
Gebürstetes Nickel



400
Cromo brillo
Chromé brillant
Bright chrome
Glänzend verchromt









800
Cromo mate
Chromé mat
Dull chrome
Matt verchromt



Synthesis

Zamak	A	B	C	D
7661	192	230	44	24
7662	96	135	44	24
7663	32	71	44	24

Acabado / Finition / Finish / Oberfläche

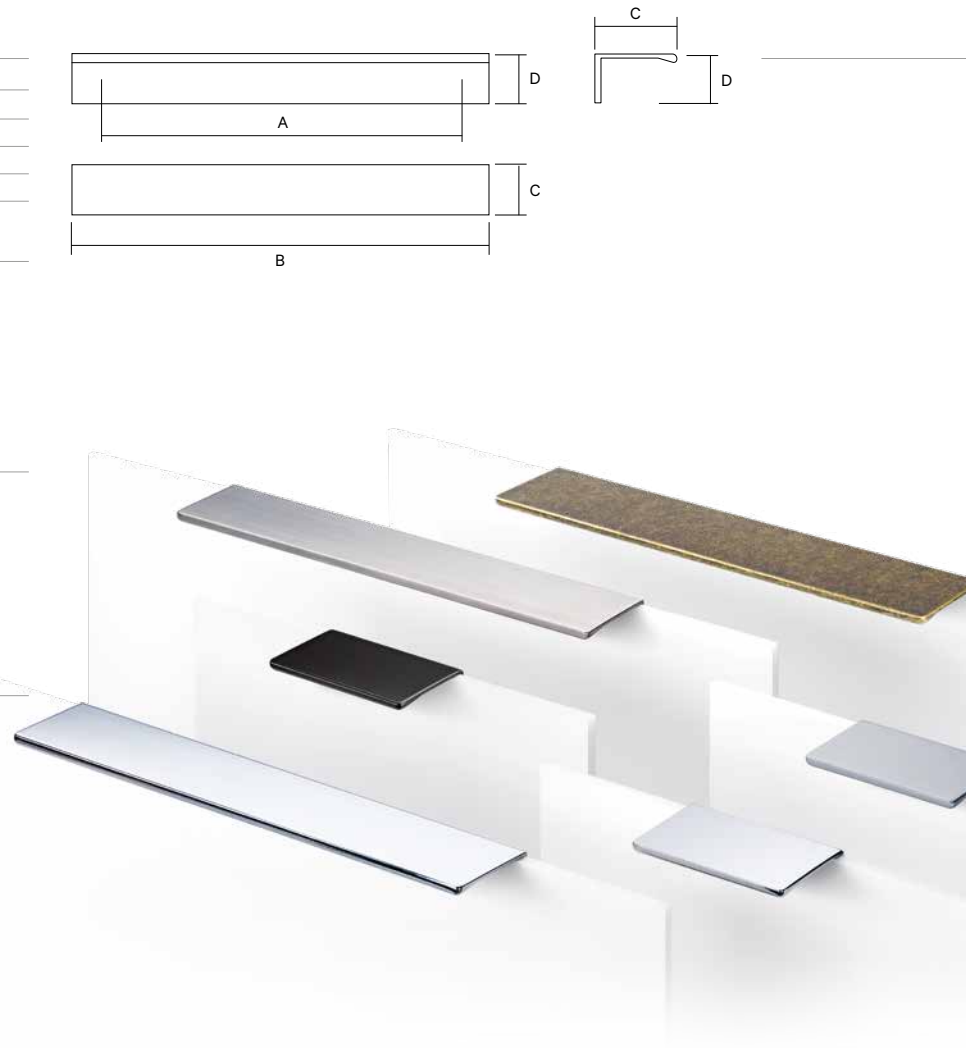

		
021 Aluminio Aluminium Aluminium Aluminium	032 Negro mate Noir mat Dull black Mattschwarz	038 Niquel cepillado Nickelé brossé Brushed Nickel Gebürstetes Nickel
		
292 Blanco mate Blanc mat Dull white Matt Weiß	400 Cromo brillo Chromé brillant Bright chrome Glänzend verchromt	800 Cromo mate Chromé mat Dull chrome Matt verchromt
		
808 Cobre rústico Cuivre rustique Rustic copper Kupfer rustikal	831 Bronce rústico Bronze rustique Antique brass Bronze rustikal	836 Estaño rústico Etain rustique Rustic tin Zinn rustikal



Symbiosis

Zamak	A	B	C	D	E
9381	192	208	12	29	16
9382	160	176	12	29	16
9383	128	144	12	29	16

Acabado / Finition / Finish / Oberfläche

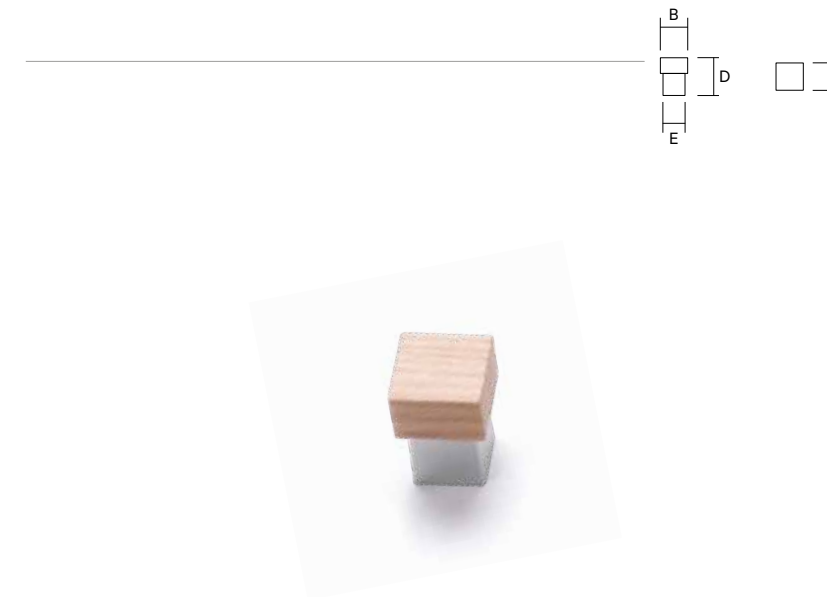
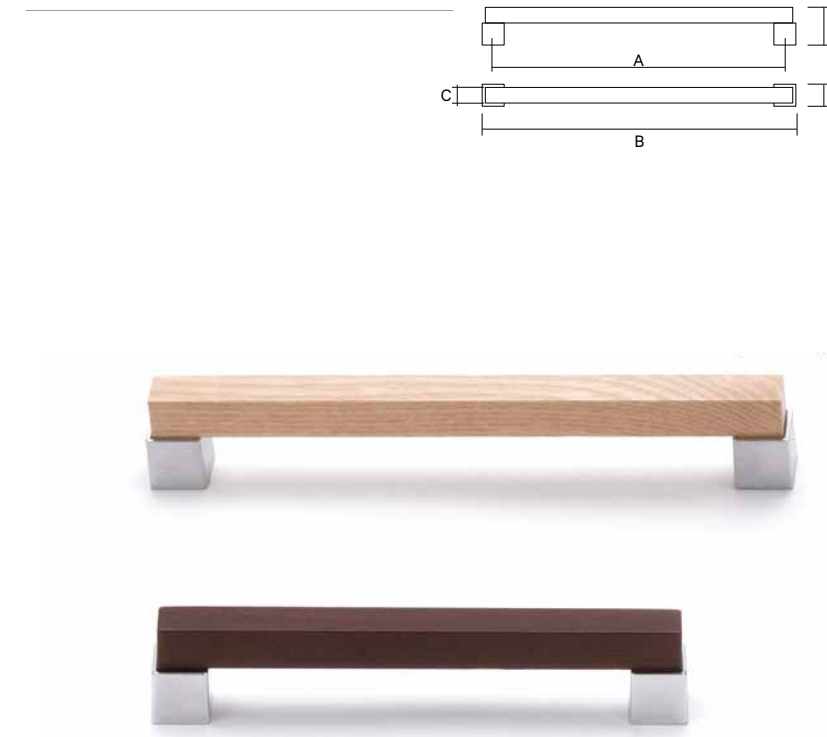

	
800 Cromo mate/Fresno, barniz wengue Chromé mat/Frêne, vernis wengué Dull chrome/Ash tree, wengue varnish Matt verchromt/Esche, Wenge lackiert	815 Cromo mate/Haya, barniz transparente Chromé mat/Hêtre, vernis transparent Dull chrome/Beech, transparent varnish Chrom matt/Buche, transparentlackiert



Symbiosis

Zamak	B	C	D	E
9090	21	21	29	16

Acabado / Finition / Finish / Oberfläche

	
800 Cromo mate/Fresno, barniz wengue Chromé mat/Frêne, vernis wengué Dull chrome/Ash tree, wengue varnish Matt verchromt/Esche, Wenge lackiert	815 Cromo mate/Haya, barniz transparente Chromé mat/Hêtre, vernis transparent Dull chrome/Beech, transparent varnish Chrom matt/Buche, transparentlackiert

Smooth

Zamak	A	B	C	D
7651	224	232	30	28
7652	192	200	30	28
7653	160	168	30	28

Acabado / Finition / Finish / Oberfläche



038

Níquel cepillado
Nickelé brossé
Brushed Nickel
Gebürstetes Nickel



400

Cromo brillo
Chromé brillant
Bright chrome
Glänzend verchromt

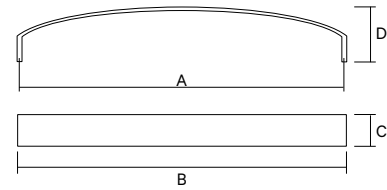

Straight

Zamak	B	C	D	E	F
3750	192	202	55	199x52	14

Acabado / Finition / Finish / Oberfläche



800

Cromo mate
Chromé mat
Dull chrome
Matt verchromt

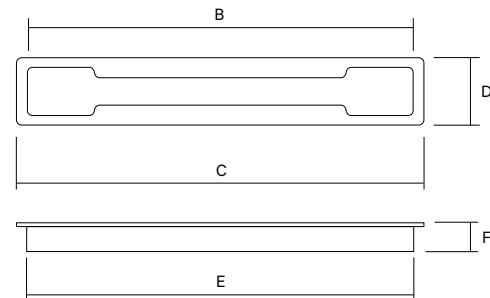

Slim

Zamak	B	C	E	F
3541	240	25	235x20	10,7
3542	150	25	145x20	10,7

Acabado / Finition / Finish / Oberfläche



038

Níquel cepillado
Nickelé brossé
Brushed Nickel
Gebürstetes Nickel



800

Cromo mate
Chromé mat
Dull chrome
Matt verchromt

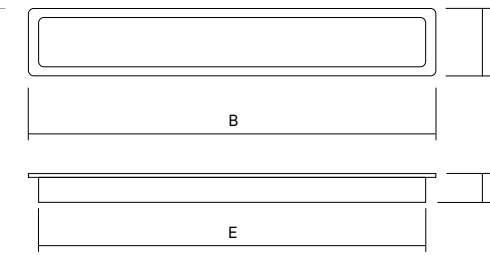

Seize

Zamak	B	C	D	E	F
3720	160	180	50	175x45	16

Acabado / Finition / Finish / Oberfläche



021
Aluminio
Aluminium
Aluminium
Aluminium



038
Níquel cepillado
Nickelé brossé
Brushed Nickel
Gebürstetes Nickel



400
Cromo brillo
Chromé brillant
Bright chrome
Glänzend verchromt



800
Cromo mate
Chromé mat
Dull chrome
Matt verchromt

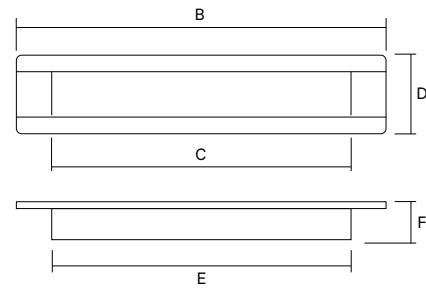

Seize

Zamak	B	C	D	E	F
3740	160	180	45	168x40	16

Acabado / Finition / Finish / Oberfläche



021
Aluminio
Aluminium
Aluminium
Aluminium

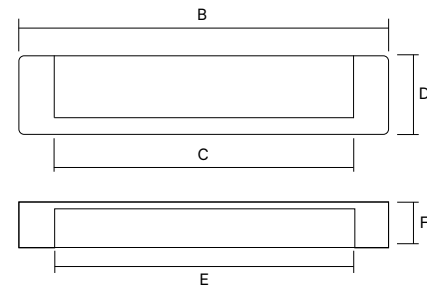

Seize

Zamak	B	C	D	E	F
3730	170	180	25	157x19	18

Acabado / Finition / Finish / Oberfläche



021
Aluminio
Aluminium
Aluminium
Aluminium

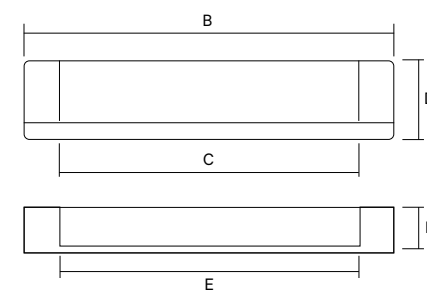

Stripe

Zamak	A	B	C	D
7681	192	238	25	27
7682	160	195	24	27
7683	128	153	23	27
7684	96	120	22	27

Acabado / Finition / Finish / Oberfläche



021
Aluminio
Aluminium
Aluminium
Aluminium



038
Níquel cepillado
Nickelé brossé
Brushed Nickel
Gebürstetes Nickel



400
Cromo brillo
Chromé brillant
Bright chrome
Glänzend verchromt



800
Cromo mate
Chromé mat
Dull chrome
Matt verchromt

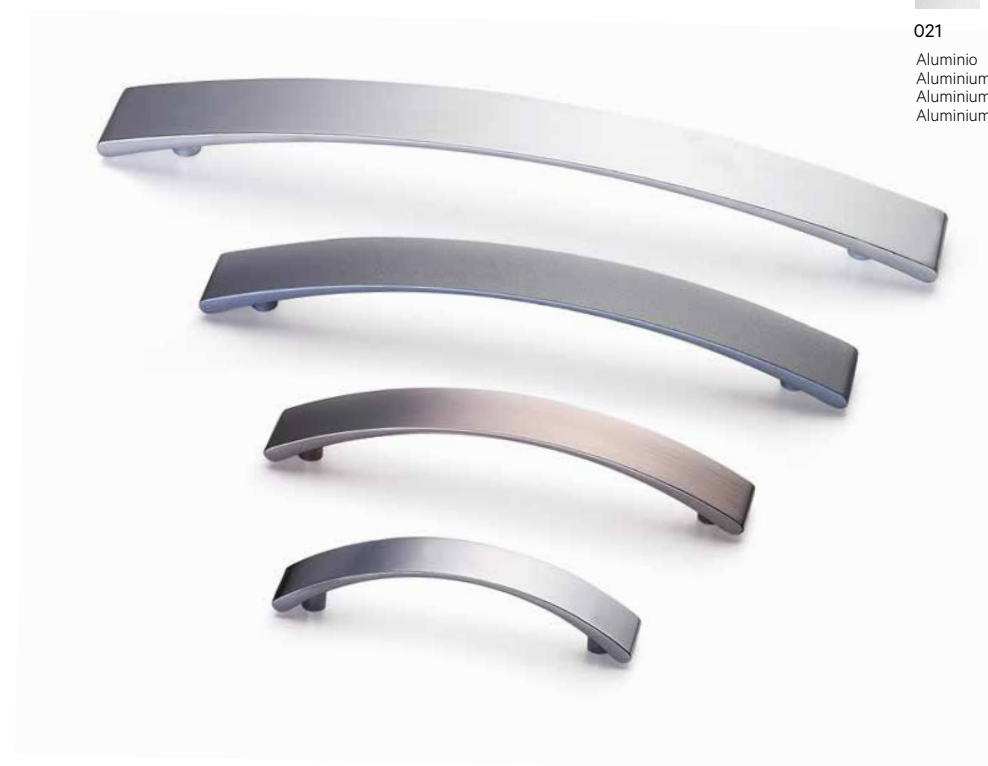
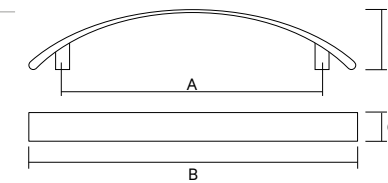

Block

Zamak	A	B	C	D
7461	160	197	21	25
7462	128	161	19	25
7463	96	129	18	25

Acabado / Finition / Finish / Oberfläche



021
Aluminio
Aluminium
Aluminium
Aluminium



038
Níquel cepillado
Nickelé brossé
Brushed Nickel
Gebürstetes Nickel



400
Cromo brillo
Chromé brillant
Bright chrome
Glänzend verchromt



800
Cromo mate
Chromé mat
Dull chrome
Matt verchromt

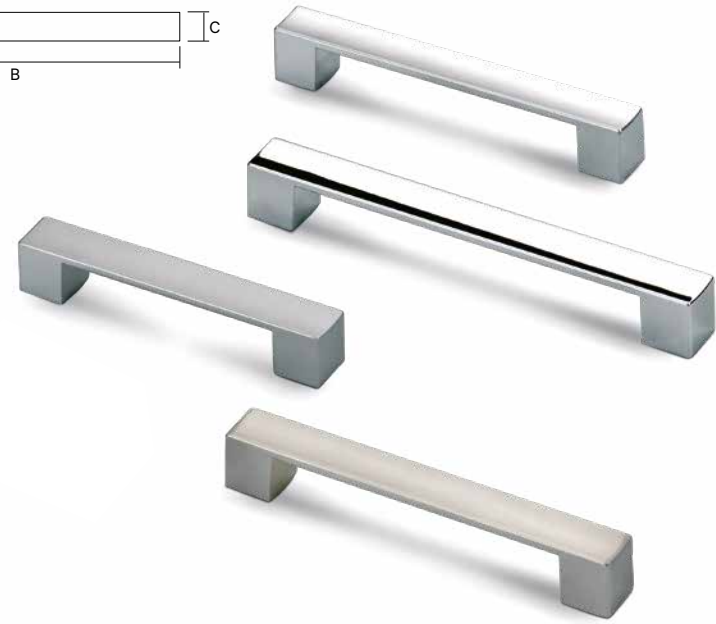
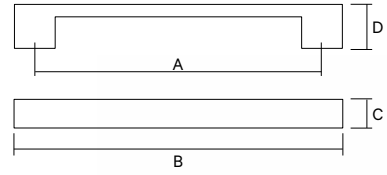

Block

Zamak	B	C	D	E
8080	16	37	25	24x12

Acabado / Finition / Finish / Oberfläche



038
Níquel cepillado
Nickelé brossé
Brushed Nickel
Gebürstetes Nickel



400
Cromo brillo
Chromé brillant
Bright chrome
Glänzend verchromt



800
Cromo mate
Chromé mat
Dull chrome
Matt verchromt

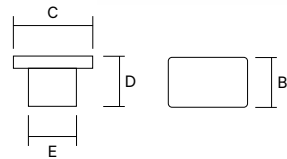

Alustyle

Zamak	A	B	C	D
7020	448	462	14	35
7021	384	398	14	35
7022	288	302	14	35
7023	224	238	14	35
7024	192	206	14	35
7025	160	174	14	35
7026	128	142	14	35
7520	832	846	14	35
7521	640	654	14	35

Acabado / Finition / Finish / Oberfläche



018
Aluminio anodizado
Aluminium anodisé
Anodized aluminium
Aluminium eloxiert

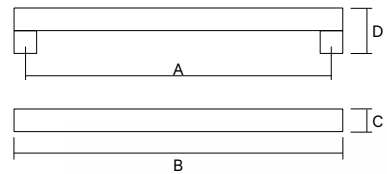

Square

Zamak	A	B	C	D
7471	128	146	12	30
7472	96	114	11	30
7473	64	81	10	29

Acabado / Finition / Finish / Oberfläche



021
Aluminio
Aluminium
Aluminium
Aluminium



038
Níquel cepillado
Nickelé brossé
Brushed Nickel
Gebürstetes Nickel



400
Cromo brillo
Chromé brillant
Bright chrome
Glänzend verchromt



800
Cromo mate
Chromé mat
Dull chrome
Matt verchromt



808
Cobre rústico
Cuivre rustique
Rustic copper
Kupfer rustikal



831
Bronce rústico
Bronze rustique
Antique brass
Bronze rustikal



836
Estaño rústico
Etain rustique
Rustic tin
Zinn rustikal

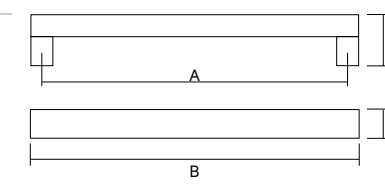

Square

Zamak	B	C	D
8090	12	12	24

Acabado / Finition / Finish / Oberfläche



021
Aluminio
Aluminium
Aluminium
Aluminium



038
Níquel cepillado
Nickelé brossé
Brushed Nickel
Gebürstetes Nickel



400
Cromo brillo
Chromé brillant
Bright chrome
Glänzend verchromt



800
Cromo mate
Chromé mat
Dull chrome
Matt verchromt

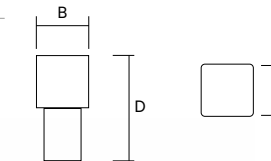

Cubic

Zamak	A	B	C	D
7481	96	115	12	21
7482	64	85	11	20
7483	32	55	10	19

Acabado / Finition / Finish / Oberfläche



021
Aluminio
Aluminium
Aluminium
Aluminium



038
Níquel cepillado
Nickelé brossé
Brushed Nickel
Gebürstetes Nickel



400
Cromo brillo
Chromé brillant
Bright chrome
Glänzend verchromt



800
Cromo mate
Chromé mat
Dull chrome
Matt verchromt

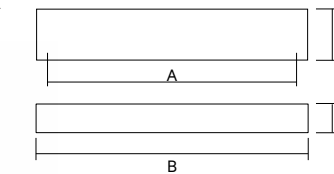

Lava

Zamak	A	B	C	D
7241	192	200	20	25
7242	160	168	20	25

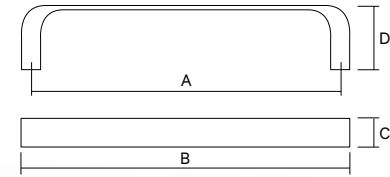

Acabado / Finition / Finish / Oberfläche



021

Aluminio
Aluminium
Aluminium
Aluminium



038

Níquel cepillado
Nickelé brossé
Brushed Nickel
Gebürstetes Nickel



400

Cromo brillo
Chromé brillant
Bright chrome
Glänzend verchromt



800

Cromo mate
Chromé mat
Dull chrome
Matt verchromt



Daen

Zamak	B	C	D
8851	50	35	26
8852	35	24	24

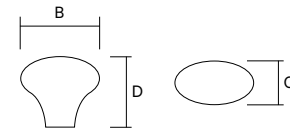

Acabado / Finition / Finish / Oberfläche



038

Níquel cepillado
Nickelé brossé
Brushed Nickel
Gebürstetes Nickel



400

Cromo brillo
Chromé brillant
Bright chrome
Glänzend verchromt



800

Cromo mate
Chromé mat
Dull chrome
Matt verchromt



Tak

Zamak	A	B	C	D
7321	192	208	24	26
7322	160	176	24	26

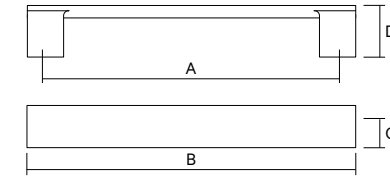

Acabado / Finition / Finish / Oberfläche



021

Aluminio
Aluminium
Aluminium
Aluminium



038

Níquel cepillado
Nickelé brossé
Brushed Nickel
Gebürstetes Nickel



400

Cromo brillo
Chromé brillant
Bright chrome
Glänzend verchromt



800

Cromo mate
Chromé mat
Dull chrome
Matt verchromt

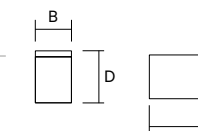

Tak

Zamak	B	C	D
8800	20	26	27

Acabado / Finition / Finish / Oberfläche



021

Aluminio
Aluminium
Aluminium
Aluminium



038

Níquel cepillado
Nickelé brossé
Brushed Nickel
Gebürstetes Nickel



400

Cromo brillo
Chromé brillant
Bright chrome
Glänzend verchromt



800

Cromo mate
Chromé mat
Dull chrome
Matt verchromt



Bridge

Zamak	A	B	C	D
7131	128	165	20	28
7132	96	130	16	25

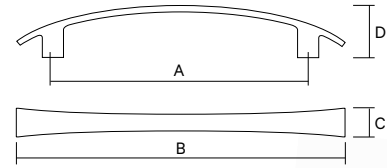

Acabado / Finition / Finish / Oberfläche

021 Aluminio Aluminium Aluminium Aluminium	032 Negro mate Noir mat Dull black Mattschwarz	038 Níquel cepillado Nickelé brossé Brushed Nickel Gebürstetes Nickel	100 Dorado brillo Doré brillant Gold plated Glänzend vergoldet
400 Cromo brillo Chromé brillant Bright chrome Glänzend verchromt	500 Níquel mate Nickelé mat Dull nickel Matt Nickel	800 Cromo mate Chromé mat Dull chrome Matt verchromt	



Bridge

Zamak	A	B	C	D
7140	32	53	19	22

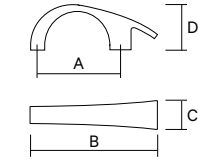

Acabado / Finition / Finish / Oberfläche

021 Aluminio Aluminium Aluminium Aluminium	032 Negro mate Noir mat Dull black Mattschwarz	038 Níquel cepillado Nickelé brossé Brushed Nickel Gebürstetes Nickel	100 Dorado brillo Doré brillant Gold plated Glänzend vergoldet
400 Cromo brillo Chromé brillant Bright chrome Glänzend verchromt	500 Níquel mate Nickelé mat Dull nickel Matt Nickel	800 Cromo mate Chromé mat Dull chrome Matt verchromt	



Bell

Zamak	A	B	C	D
7051	128	148	16	35
7052	96	112	13	31

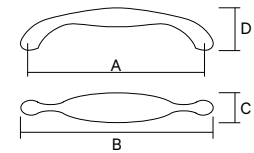

Acabado / Finition / Finish / Oberfläche

038 Níquel cepillado Nickelé brossé Brushed Nickel Gebürstetes Nickel	100 Dorado brillo Doré brillant Gold plated Glänzend vergoldet	400 Cromo brillo Chromé brillant Bright chrome Glänzend verchromt	800 Cromo mate Chromé mat Dull chrome Matt verchromt



Sui

Zamak	A	B	C	D
7031	128	160	14	28
7032	96	126	13	26

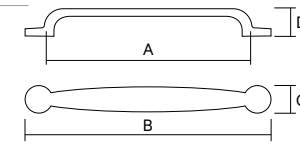

Acabado / Finition / Finish / Oberfläche

030 Bronce cepillado Bronze brossé Brushed bronze Gebürstet bronziert	038 Níquel cepillado Nickelé brossé Brushed Nickel Gebürstetes Nickel	100 Dorado brillo Doré brillant Gold plated Glänzend vergoldet	400 Cromo brillo Chromé brillant Bright chrome Glänzend verchromt
800 Cromo mate Chromé mat Dull chrome Matt verchromt	807 Hierro rústico Fer rustique Rustic iron Eisen rustikal	831 Bronce rústico Bronze rustique Antique brass Bronze rustikal	836 Estaño rústico Etain rustique Rustic tin Zinn rustikal



Luk

Zamak	A	B	C	D
7861	128	164	10	30
7862	96	124	9	29

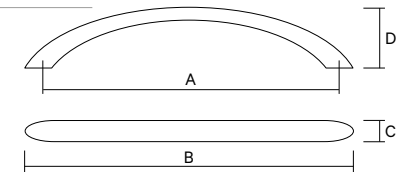

Acabado / Finition / Finish / Oberfläche

002 Blanco Blanc White Weiß	021 Aluminio Aluminium Aluminium Aluminium	033 Negro brillo Noir brillant Bright black Glänzend schwarz	038 Níquel cepillado Nickelé brossé Brushed Nickel Gebürstetes Nickel
100 Dorado brillo Doré brillant Gold plated Glänzend vergoldet	400 Cromo brillo Chromé brillant Bright chrome Glänzend verchromt	500 Níquel mate Nickelé mat Dull nickel Matt Nickel	800 Cromo mate Chromé mat Dull chrome Matt verchromt



Up

Zamak	A	B	C	D
3281	64	90	10	50

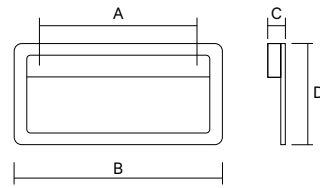

Acabado / Finition / Finish / Oberfläche

002	038	400	500	800
Blanco Blanc White Weiß	Níquel cepillado Nickelé brossé Brushed Nickel Gebürstetes Nickel	Cromo brillo Chromé brillant Bright chrome Glänzend verchromt	Níquel mate Nickelé mat Dull nickel Matt Nickel	Cromo mate Chromé mat Dull chrome Matt verchromt

Up

Zamak	A	B	C	D
3282	16	42	10	74

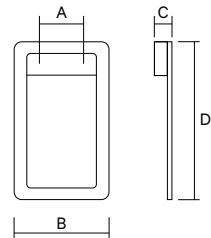

Acabado / Finition / Finish / Oberfläche

002	038	400	500	800
Blanco Blanc White Weiß	Níquel cepillado Nickelé brossé Brushed Nickel Gebürstetes Nickel	Cromo brillo Chromé brillant Bright chrome Glänzend verchromt	Níquel mate Nickelé mat Dull nickel Matt Nickel	Cromo mate Chromé mat Dull chrome Matt verchromt

Stylus

Zamak	B	C	D	E	F
3600	64	60	64	60	11
3560	50	45	50	45	11
3561	39	35	39	35	11
3562	29	26	29	26	11

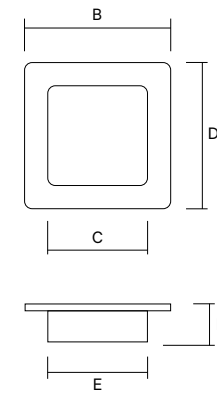

Acabado / Finition / Finish / Oberfläche

038	100	400	800
Níquel cepillado Nickelé brossé Brushed Nickel Gebürstetes Nickel	Dorado brillo Doré brillant Gold plated Glänzend vergoldet	Cromo brillo Chromé brillant Bright chrome Glänzend verchromt	Cromo mate Chromé mat Dull chrome Matt verchromt

Stylus

Zamak	C	D	E	F
3500	60	65	60	11
3510	45	49	45	11
3511	35	40	35	11
3512	26	30	26	11

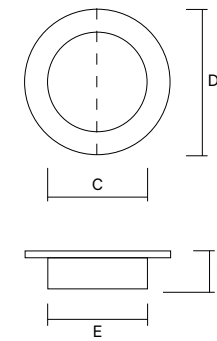

Acabado / Finition / Finish / Oberfläche

002	032	038	100
Blanco Blanc White Weiß	Negro mate Noir mat Dull black Mattschwarz	Níquel cepillado Nickelé brossé Brushed Nickel Gebürstetes Nickel	Dorado brillo Doré brillant Gold plated Glänzend vergoldet

292	400	800
Blanco mate Blanc mat Dull white Matt Weiß	Cromo brillo Chromé brillant Bright chrome Glänzend verchromt	Cromo mate Chromé mat Dull chrome Matt verchromt

Nut

Zamak	B	C	D
8671	34	22	36
8672	31	20	29
8673	25	17	26

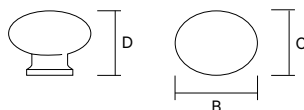

Acabado / Finition / Finish / Oberfläche

038 Níquel cepillado Nickelé brossé Brushed Nickel Gebürstetes Nickel	100 Dorado brillo Doré brillant Gold plated Glänzend vergoldet	400 Cromo brillo Chromé brillant Bright chrome Glänzend verchromt	800 Cromo mate Chromé mat Dull chrome Matt verchromt

Key

Zamak	A	B	C	D
7291	64	81	12	20
7292	32	48	12	20

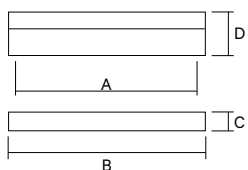

Acabado / Finition / Finish / Oberfläche

021 Aluminio Aluminium Aluminium	038 Níquel cepillado Nickelé brossé Brushed Nickel Gebürstetes Nickel	400 Cromo brillo Chromé brillant Bright chrome Glänzend verchromt	500 Níquel mate Nickelé mat Dull nickel Matt Nickel	800 Cromo mate Chromé mat Dull chrome Matt verchromt

Kilt

Zamak	A	B	C	D
7281	192	242	12	35
7282	128	178	12	35

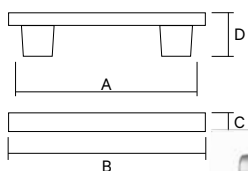

Acabado / Finition / Finish / Oberfläche

038 Níquel cepillado Nickelé brossé Brushed Nickel Gebürstetes Nickel	400 Cromo brillo Chromé brillant Bright chrome Glänzend verchromt

Zubi

Zamak	A	B	C	D
7150	96	152	20	27

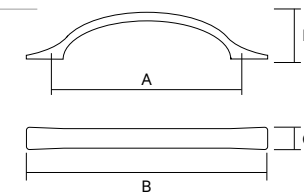

Acabado / Finition / Finish / Oberfläche

020 Oro cepillado Or brossé Brushed Gold Gebürstetes Gold	021 Aluminio Aluminium Aluminium	038 Níquel cepillado Nickelé brossé Brushed Nickel Gebürstetes Nickel	250 Oro mate Or mat Dull gold Matt Gold
400 Cromo brillo Chromé brillant Bright chrome Glänzend verchromt	500 Níquel mate Nickelé mat Dull nickel Matt Nickel	750 Grafito Graphite Graphite Graphit	800 Cromo mate Chromé mat Dull chrome Matt verchromt

Halo

Zamak	D	E
8701	26	35
8702	23	30

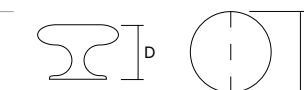

Acabado / Finition / Finish / Oberfläche

002 Blanco Blanc White Weiß	030 Bronce cepillado Bronze brossé Brushed bronze Gebürstet bronziert	038 Níquel cepillado Nickelé brossé Brushed Nickel Gebürstetes Nickel	100 Dorado brillo Doré brillant Gold plated Glänzend vergoldet
400 Cromo brillo Chromé brillant Bright chrome Glänzend verchromt	800 Cromo mate Chromé mat Dull chrome Matt verchromt	831 Bronce rústico Bronze rustique Antique brass Bronze rustikal	836 Estaño rústico Etain rustique Rustic tin Zinn rustikal

Golf

Zamak	B	C	D
8711	37	30	30
8712	32	26	26

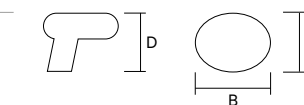

Acabado / Finition / Finish / Oberfläche

038 Níquel cepillado Nickelé brossé Brushed Nickel Gebürstetes Nickel	800 Cromo mate Chromé mat Dull chrome Matt verchromt

Gumb

Zamak	D	E
8731	26	35
8732	22	30

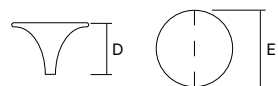

Acabado / Finition / Finish / Oberfläche



038
Níquel cepillado
Nickelé brossé
Brushed Nickel
Gebürstetes Nickel

Boog

Zamak	A	B	C	D
7081	128	142	15	32
7082	96	107	13	28

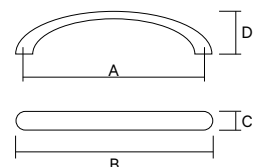

Acabado / Finition / Finish / Oberfläche



038
Níquel cepillado
Nickelé brossé
Brushed Nickel
Gebürstetes Nickel

Asia

Zamak	A	B	C	D
7061	96	130	11	28

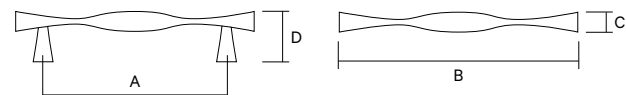

Acabado / Finition / Finish / Oberfläche



032
Negro mate
Noir mat
Dull black
Mattschwarz



038
Níquel cepillado
Nickelé brossé
Brushed Nickel
Gebürstetes Nickel



100
Dorado brillo
Doré brillant
Gold plated
Glänzend vergoldet



800
Cromo mate
Chromé mat
Dull chrome
Matt verchromt

Assa

Zamak	A	B	C	D
7552	96	108	10	27
7553	70	80	9	26

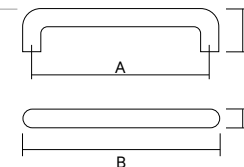

Acabado / Finition / Finish / Oberfläche



002
Blanco
Blanc
White
Weiß



033
Negro brillo
Noir brillant
Bright black
Glänzend schwarz



100
Dorado brillo
Doré brillant
Gold plated
Glänzend vergoldet



400
Cromo brillo
Chromé brillant
Bright chrome
Glänzend verchromt

Assa

Zamak	A	B	C	D
7554	32	42	9	25

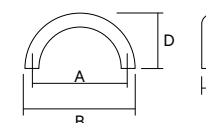

Acabado / Finition / Finish / Oberfläche



002
Blanco
Blanc
White
Weiß



033
Negro brillo
Noir brillant
Bright black
Glänzend schwarz



100
Dorado brillo
Doré brillant
Gold plated
Glänzend vergoldet



400
Cromo brillo
Chromé brillant
Bright chrome
Glänzend verchromt

Tip

Zamak	B	C	D
8830	30	19	19

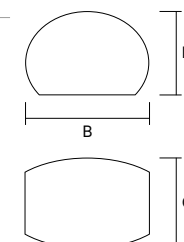

Acabado / Finition / Finish / Oberfläche



021
Aluminio
Aluminium
Aluminium
Aluminium



038
Níquel cepillado
Nickelé brossé
Brushed Nickel
Gebürstetes Nickel



400
Cromo brillo
Chromé brillant
Bright chrome
Glänzend verchromt



800
Cromo mate
Chromé mat
Dull chrome
Matt verchromt

Tee

Zamak	B	C	D
8820	16	27	16



Acabado / Finition / Finish / Oberfläche



021
Aluminio
Aluminium
Aluminium
Aluminium



038
Níquel cepillado
Nickelé brossé
Brushed Nickel
Gebürstetes Nickel

Bold

Zamak	D	E
8351	40	33
8352	33	28
8353	28	24
8354	23	18

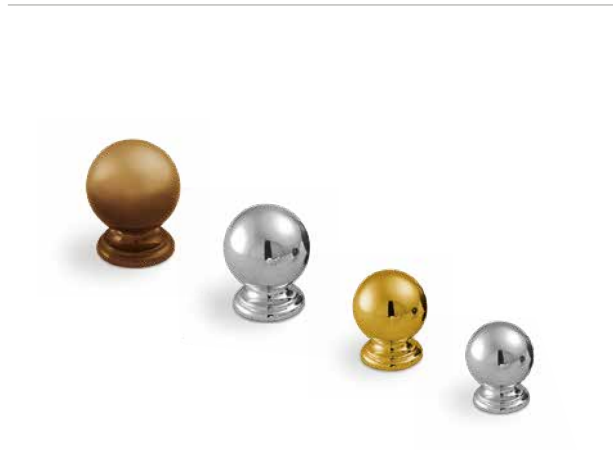
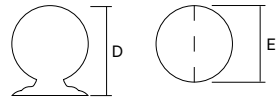

Acabado / Finition / Finish / Oberfläche

100	400	800	900
Dorado brillo Doré brillant Gold plated Glänzend vergoldet	Cromo brillo Chromé brillant Bright chrome Glänzend verchromt	Cromo mate Chromé mat Dull chrome Matt verchromt	Bronce viejo Vieux bronze Old bronze Antik bronziert

Tama

Zamak	D	E
8321	36	33
8322	32	28
8323	28	24
8324	22	18

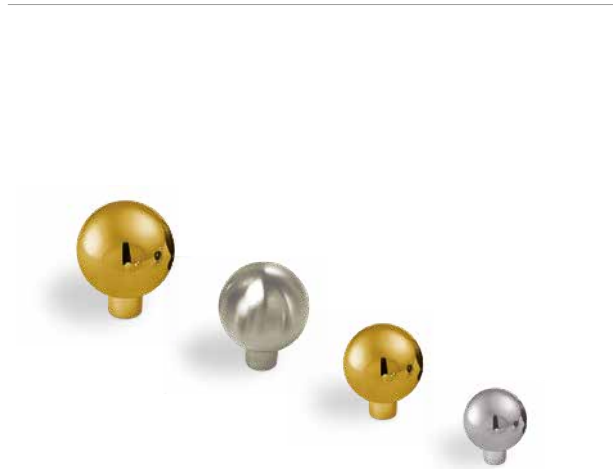
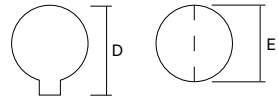

Acabado / Finition / Finish / Oberfläche

038	100	400	800
Níquel cepillado Nickelé brossé Brushed Nickel Gebürstetes Nickel	Dorado brillo Doré brillant Gold plated Glänzend vergoldet	Cromo brillo Chromé brillant Bright chrome Glänzend verchromt	Cromo mate Chromé mat Dull chrome Matt verchromt

Kani

Zamak	D	E
8010	28	12

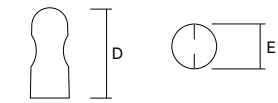

Acabado / Finition / Finish / Oberfläche

002	021	033	100	400
Blanco Blanc White Weiß	Aluminio Aluminium Aluminium Aluminium	Negro brillo Noir brillant Bright black Glänzend schwarz	Dorado brillo Doré brillant Gold plated Glänzend vergoldet	Cromo brillo Chromé brillant Bright chrome Glänzend verchromt

Dob

Zamak	D	E
8471	32	35
8472	26	30
8473	23	25

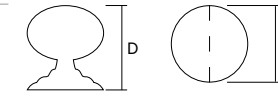

Acabado / Finition / Finish / Oberfläche

100	102	400	900
Dorado brillo Doré brillant Gold plated Glänzend vergoldet	Blanco/Dorado brillo Blanc/Doré brillant White/Gold plated Weiß/Glänzend vergoldet	Cromo brillo Chromé brillant Bright chrome Glänzend verchromt	Bronce viejo Vieux bronze Old bronze Antik bronziert

Tau

Zamak	D	E
8461	28	35
8462	25	30
8463	21	25

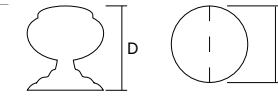

Acabado / Finition / Finish / Oberfläche

100	805	900
Dorado brillo Doré brillant Gold plated Glänzend vergoldet	Latón cepillado rústico Laiton brossé rustique Rustic brushed brass Messing rustikal, gebürstet	Bronce viejo Vieux bronze Old bronze Antik bronziert

Med

Zamak	D	E
8721	28	18
8722	21	13

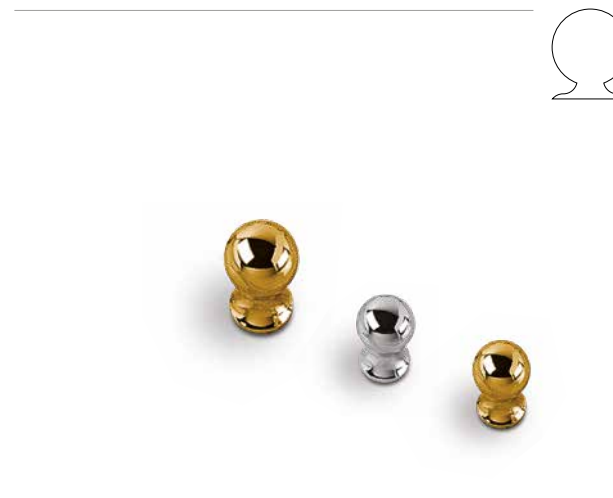
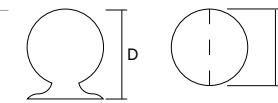

Acabado / Finition / Finish / Oberfläche

021	038	100	400
Aluminio Aluminium Aluminium Aluminium	Níquel cepillado Nickelé brossé Brushed Nickel Gebürstetes Nickel	Dorado brillo Doré brillant Gold plated Glänzend vergoldet	Cromo brillo Chromé brillant Bright chrome Glänzend verchromt

Toru

Acero inoxidable-zamak / Acier inox-zamak / Stainless steel-zamak / Rostfreier Stahl-Zamak

	A	B	C	D
7000	1280	1310	14	35
7001	896	926	14	35
7002	672	702	14	35
7003	448	478	14	35
7004	384	414	14	35
7005	288	318	14	35
7006	224	254	14	35
7007	192	222	14	35
7008	160	190	14	35
7009	128	158	14	35

Acabado / Finition / Finish / Oberfläche



031

Inoxidable cepillado
Inox brossé
Brushed stainless
Rostfreier Stahl, gebürstet

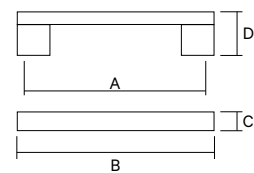

Rod

Acero inoxidable-zamak / Acier inox-zamak / Stainless steel-zamak / Rostfreier Stahl-Zamak

	A	B	C	D
7610	288	298	26	10
7611	192	202	25,5	10
7612	160	170	25,5	10
7613	128	138	25,5	10
7614	96	106	25	10
7810	192	200	21	8
7811	160	168	21	8
7812	128	136	21	8
7813	96	104	21	8
7814	64	72	21	8

Acabado / Finition / Finish / Oberfläche



031

Inoxidable cepillado
Inox brossé
Brushed stainless
Rostfreier Stahl, gebürstet



037

Inoxidable pulido
Inox poli brillant
Polished stainless
Rostfreier Stahl, hochglanz

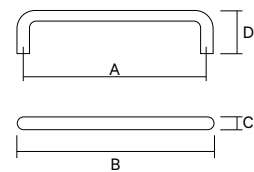

Unix

Zamak

	A	B	C	D
7501	320	333	25	38
7502	288	301	25	38
7503	256	269	25	38
7504	224	237	25	38
7505	192	205	25	38
7506	160	173	25	38

Acabado / Finition / Finish / Oberfläche



031

Inoxidable cepillado
Inox brossé
Brushed stainless
Rostfreier Stahl, gebürstet

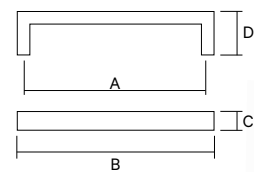

Ror

Acero inoxidable-zamak / Acier inox-zamak / Stainless steel-zamak / Rostfreier Stahl-Zamak

	A	B	C	D
7010	1280	1330	12	32
7011	896	946	12	32
7012	672	722	12	32
7013	448	498	12	32
7014	384	434	12	32
7015	288	338	12	32
7016	224	274	12	32
7017	192	242	12	32
7018	160	210	12	32
7019	128	178	12	32

Acabado / Finition / Finish / Oberfläche



031

Inoxidable cepillado
Inox brossé
Brushed stainless
Rostfreier Stahl, gebürstet

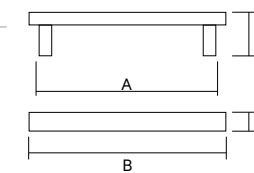

Buis

Acero inoxidable-zamak / Acier inox-zamak / Stainless steel-zamak / Rostfreier Stahl-Zamak

	A	B	C	D
7921	160	200	10	27
7922	128	166	10	27
7923	96	132	10	27

Acabado / Finition / Finish / Oberfläche



031

Inoxidable cepillado
Inox brossé
Brushed stainless
Rostfreier Stahl, gebürstet

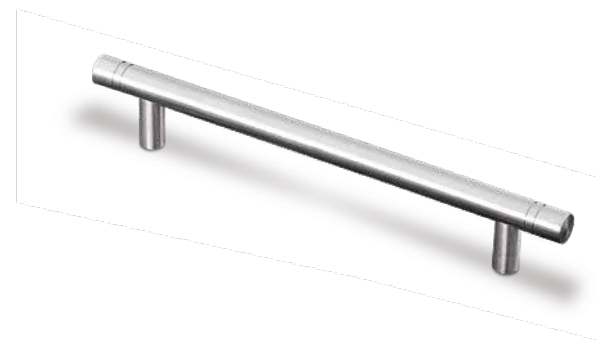
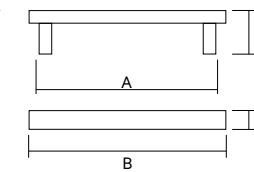

Buis

Acero inoxidable-zamak / Acier inox-zamak / Stainless steel-zamak / Rostfreier Stahl-Zamak

	D	E
8921	27	18
8922	22	13

Acabado / Finition / Finish / Oberfläche



031

Inoxidable cepillado
Inox brossé
Brushed stainless
Rostfreier Stahl, gebürstet

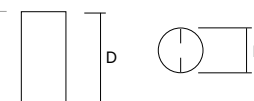

Dopp

Acero inoxidable-zamak / Acier inox-zamak / Stainless steel-zamak / Rostfreier Stahl-Zamak

	D	E
8361	35	30
8362	27	25
8363	22	20

Acabado / Finition / Finish / Oberfläche



031

Inoxidable cepillado
Inox brossé
Brushed stainless
Rostfreier Stahl, gebürstet



037

Inoxidable pulido
Inox poli brillant
Polished stainless
Rostfreier Stahl, hochglanz

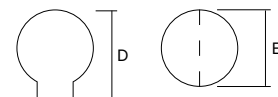

Pil

Acero inoxidable-zamak / Acier inox-zamak / Stainless steel-zamak / Rostfreier Stahl-Zamak

	A	B	C	D
7861	128	145	10	30
7862	96	110	10	29

Acabado / Finition / Finish / Oberfläche



031

Inoxidable cepillado
Inox brossé
Brushed stainless
Rostfreier Stahl, gebürstet

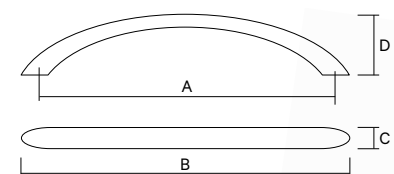

Orb

Poli-dur-zamak / Poli-dur-zamak / Poli-dur-zamak / Poli-dur-Zamak

	D	E
5101	38	34
5102	32	28

Acabado / Finition / Finish / Oberfläche



102

Blanco/Dorado brillo
Blanc/Doré brillant
White/Gold plated
Weiß/Glänzend vergoldet



133

Negro brillo/Dorado brillo
Noir brillant/Doré brillant
Bright black/Gold plated
Glänzend schwarz/Glänzend vergoldet

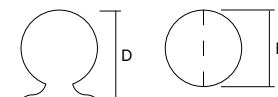

Klot

Poli-dur-zamak / Poli-dur-zamak / Poli-dur-zamak / Poli-dur-Zamak

	D	E
5001	36	34
5002	28	28

Acabado / Finition / Finish / Oberfläche



002

Blanco
Blanc
White
Weiß



033

Negro brillo
Noir brillant
Bright black
Glänzend schwarz

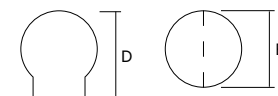

Nou

Poli-dur-zamak / Poli-dur-zamak / Poli-dur-zamak / Poli-dur-Zamak

	D	E
5221	30	37
5222	26	32

Acabado / Finition / Finish / Oberfläche



002

Blanco
Blanc
White
Weiß



033

Negro brillo
Noir brillant
Bright black
Glänzend schwarz

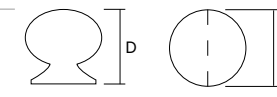

Polidur

Poli-dur-zamak / Poli-dur-zamak / Poli-dur-zamak / Poli-dur-Zamak

	D	E
5201	38	34
5202	32	28

Acabado / Finition / Finish / Oberfläche



002

Blanco
Blanc
White
Weiß



033

Negro brillo
Noir brillant
Bright black
Glänzend schwarz

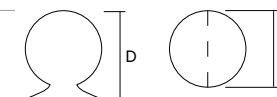

Sene

Madera / Bois / Wood / Holz

	D	E
9062	32	40
9063	25	30

Acabado / Finition / Finish / Oberfläche



014

Haya, sin barniz
Hêtre, non verni
Beech, unvarnished
Buche, unlackiert



015

Haya, barniz transparente
Hêtre, vernis transparent
Beech, transparent varnish
Buche, transparentlackiert



016

Haya, barniz nogal
Hêtre, vernis noyer
Beech, walnut varnish
Buche, Nußbaum lackiert



025

Pino, barniz transparente
Pin, vernis transparent
Pine, transparent varnish
Kiefer, transparentlackiert



035

Roble, barniz transparente
Chêne, vernis transparent
Oak, transparent varnish
Eiche, transparentlackiert

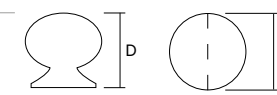

Skal

Zamak	A	B	C	D
3940	64	130	25	34

Acabado / Finition / Finish / Oberfläche



021

Aluminio
Aluminium
Aluminium
Aluminium



038

Níquel cepillado
Nickelé brossé
Brushed Nickel
Gebürstetes Nickel



805

Latón cepillado rústico
Laiton brossé rustique
Rustic brushed brass
Messing rustikal, gebürstet



807

Hierro rústico
Fer rustique
Rustic iron
Eisen rustikal



836

Estaño rústico
Etain rustique
Rustic tin
Zinn rustikal

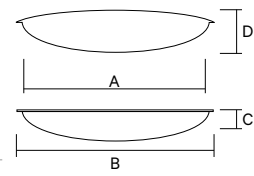

Shift

Zamak	B	C	D	E	F
3701	145	111	50	139x40	11
3702	113	85	42	110x35	11
3703	83	78	36	78x26	11

Acabado / Finition / Finish / Oberfläche



038

Níquel cepillado
Nickelé brossé
Brushed Nickel
Gebürstetes Nickel



100

Dorado brillo
Doré brillant
Gold plated
Glänzend vergoldet



400

Cromo brillo
Chromé brillant
Bright chrome
Glänzend verchromt



800

Cromo mate
Chromé mat
Dull chrome
Matt verchromt

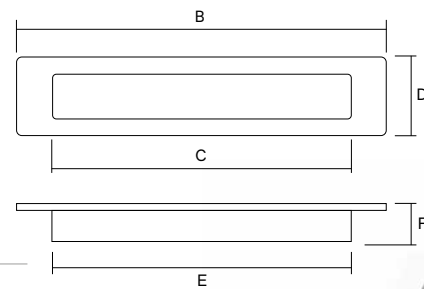

Vora

Zamak	B	C	D	E	F
3261	80	60	35	71	5

Acabado / Finition / Finish / Oberfläche



002

Blanco
Blanc
White
Weiß



038

Níquel cepillado
Nickelé brossé
Brushed Nickel
Gebürstetes Nickel



100

Dorado brillo
Doré brillant
Gold plated
Glänzend vergoldet



500

Níquel mate
Nickelé mat
Dull nickel
Matt Nickel



800

Cromo mate
Chromé mat
Dull chrome
Matt verchromt

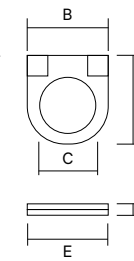
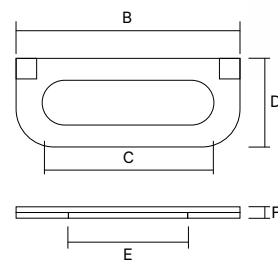

Vora

Zamak	B	C	D	E	F
3262	36	22	36	27	5

Acabado / Finition / Finish / Oberfläche



002

Blanco
Blanc
White
Weiß



038

Níquel cepillado
Nickelé brossé
Brushed Nickel
Gebürstetes Nickel



100

Dorado brillo
Doré brillant
Gold plated
Glänzend vergoldet



500

Níquel mate
Nickelé mat
Dull nickel
Matt Nickel



800

Cromo mate
Chromé mat
Dull chrome
Matt verchromt

Toka

Zamak	B	C	D	E	F
3251	72	57	40	62	6

Acabado / Finition / Finish / Oberfläche



112

Dorado brillo/Pintado dorado
Doré brillant/Peint en doré
Gold plated/Gold painted
Glänzend vergoldet/Golden bemalt



413

Cromo brillo/Pintado plata
Chromé brillant/Peint en argenté
Bright chrome/Silver painted
Glänzend verchromt/Silbern bemalt

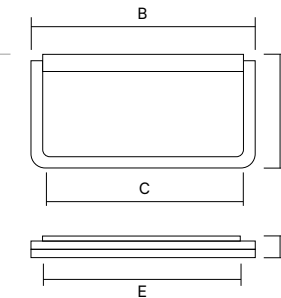

Toka

Zamak	B	C	D	E	F
3252	35	23	35	28	6

Acabado / Finition / Finish / Oberfläche



112

Dorado brillo/Pintado dorado
Doré brillant/Peint en doré
Gold plated/Gold painted
Glänzend vergoldet/Golden bemalt



413

Cromo brillo/Pintado plata
Chromé brillant/Peint en argenté
Bright chrome/Silver painted
Glänzend verchromt/Silbern bemalt

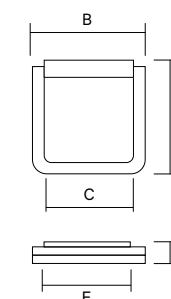

Cap

Zamak	B	C	D	E	F
3921	150	99	40	103x26	11
3922	110	65	36	69x26	11

Acabado / Finition / Finish / Oberfläche



002

Blanco
Blanc
White
Weiß



038

Níquel cepillado
Nickelé brossé
Brushed Nickel
Gebürstetes Nickel



100

Dorado brillo
Doré brillant
Gold plated
Glänzend vergoldet



400

Cromo brillo
Chromé brillant
Bright chrome
Glänzend verchromt



800

Cromo mate
Chromé mat
Dull chrome
Matt verchromt



831

Bronce rústico
Bronze rustique
Antique brass
Bronze rustikal

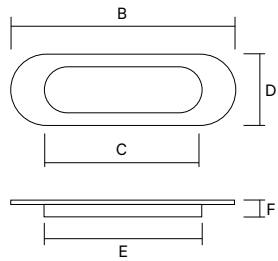

Frame

Zamak	B	C	D	E	F
3271	82	63	38	57	5

Acabado / Finition / Finish / Oberfläche



100

Dorado brillo
Doré brillant
Gold plated
Glänzend vergoldet



200

Dorado satinado
Doré satiné
Satin gold plated
Satinierteres gold



500

Níquel mate
Nickelé mat
Dull nickel
Matt Nickel

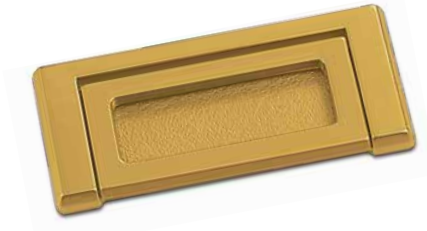
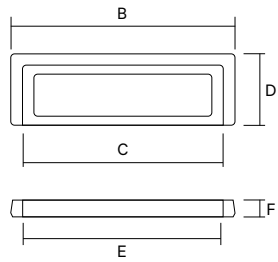

Frame

Zamak	B	C	D	E	F
3272	38	26	50	21	5

Acabado / Finition / Finish / Oberfläche



100

Dorado brillo
Doré brillant
Gold plated
Glänzend vergoldet



200

Dorado satinado
Doré satiné
Satin gold plated
Satinierteres gold



500

Níquel mate
Nickelé mat
Dull nickel
Matt Nickel

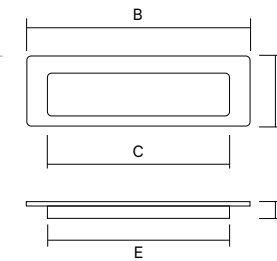
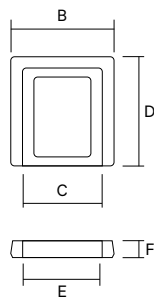

Flute

Zamak	B	C	D	E	F
3801	115		42	93x32	13
3802	80		36	67x27	13

Acabado / Finition / Finish / Oberfläche



112

Dorado brillo/Pintado dorado
Doré brillant/Peint en doré
Gold plated/Gold painted
Glänzend vergoldet/Golden bemalt



403

Cromo brillo/Negro
Chromé brillant/Noir
Bright chrome/Black
Glänzend verchromt/Schwarz



413

Cromo brillo/Pintado plata
Chromé brillant/Peint en argenté
Bright chrome/Silver painted
Glänzend verchromt/Silbern bemalt

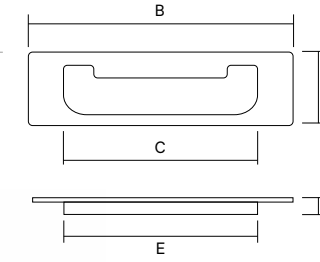

Grin

Zamak	B	C	D	E	F
3900	110	96	40	104x30	12

Acabado / Finition / Finish / Oberfläche



112

Dorado brillo/Pintado dorado
Doré brillant/Peint en doré
Gold plated/Gold painted
Glänzend vergoldet/Golden bemalt



413

Cromo brillo/Pintado plata
Chromé brillant/Peint en argenté
Bright chrome/Silver painted
Glänzend verchromt/Silbern bemalt

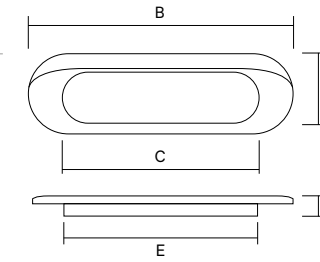
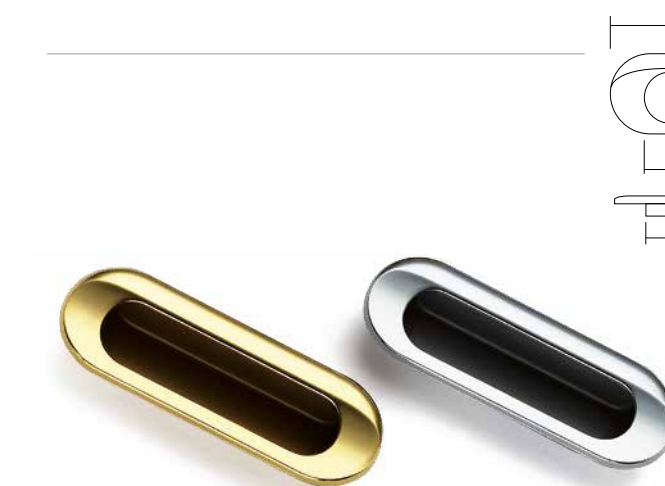

Flap

Zamak	B	C	D	E	F
3930	110	96	40	88x30	12

Acabado / Finition / Finish / Oberfläche



112

Dorado brillo/Pintado dorado
Doré brillant/Peint en doré
Gold plated/Gold painted
Glänzend vergoldet/Golden bemalt



413

Cromo brillo/Pintado plata
Chromé brillant/Peint en argenté
Bright chrome/Silver painted
Glänzend verchromt/Silbern bemalt

Provence

Zamak

	A	B	C	D
6521	96	154	22	30

Acabado / Finition / Finish / Oberfläche



805

Latón cepillado rústico
Laiton brossé rustique
Rustic brushed brass
Messing rustikal, gebürstet



825

Estaño cepillado
Etain brossé
Brushed tin
Zinn gebürstet



831

Bronce rústico
Bronze rustique
Antique brass
Bronze rustikal

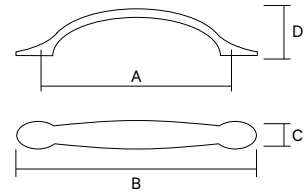

Provence

Zamak

	D	E
8521	36	24

Acabado / Finition / Finish / Oberfläche



805

Latón cepillado rústico
Laiton brossé rustique
Rustic brushed brass
Messing rustikal, gebürstet



825

Estaño cepillado
Etain brossé
Brushed tin
Zinn gebürstet



831

Bronce rústico
Bronze rustique
Antique brass
Bronze rustikal



Laps

Zamak

	A	B	C	D
6131	192	222	22	21
6132	128	159	22	21

Acabado / Finition / Finish / Oberfläche



100

Dorado brillo
Doré brillant
Gold plated
Glänzend vergoldet



400

Cromo brillo
Chromé brillant
Bright chrome
Glänzend verchromt



500

Níquel mate
Nickelé mat
Dull nickel
Matt Nickel



831

Bronce rústico
Bronze rustique
Antique brass
Bronze rustikal



836

Estaño rústico
Etain rustique
Rustic tin
Zinn rustikal



Laps

Zamak

	D	E
6130	23	45

Acabado / Finition / Finish / Oberfläche



100

Dorado brillo
Doré brillant
Gold plated
Glänzend vergoldet



400

Cromo brillo
Chromé brillant
Bright chrome
Glänzend verchromt



500

Níquel mate
Nickelé mat
Dull nickel
Matt Nickel



831

Bronce rústico
Bronze rustique
Antique brass
Bronze rustikal



836

Estaño rústico
Etain rustique
Rustic tin
Zinn rustikal

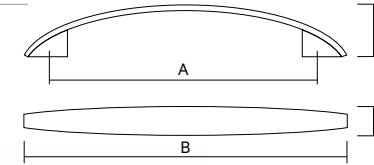
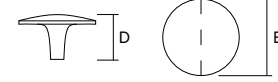

Rough

Zamak

	A	B	C	D
6151	128	169	25	27
6152	96	127	23	26

Acabado / Finition / Finish / Oberfläche



400

Cromo brillo
Chromé brillant
Bright chrome
Glänzend verchromt



500

Níquel mate
Nickelé mat
Dull nickel
Matt Nickel



831

Bronce rústico
Bronze rustique
Antique brass
Bronze rustikal



836

Estaño rústico
Etain rustique
Rustic tin
Zinn rustikal

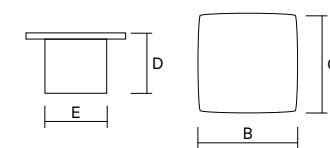

Rough

Zamak

	B	C	D	E
6150	42	42	25	24x24

Acabado / Finition / Finish / Oberfläche



400

Cromo brillo
Chromé brillant
Bright chrome
Glänzend verchromt



500

Níquel mate
Nickelé mat
Dull nickel
Matt Nickel



831

Bronce rústico
Bronze rustique
Antique brass
Bronze rustikal



836

Estaño rústico
Etain rustique
Rustic tin
Zinn rustikal

Rope

Zamak

	A	B	C	D
7581	128	150	15	30
7582	96	114	13	27

Acabado / Finition / Finish / Oberfläche



100
Dorado brillo
Doré brillant
Gold plated
Glänzend vergoldet



500
Níquel mate
Nickel mat
Dull nickel
Matt Nickel



810
Negro petróleo
Noir pétrole
Oil rubbed bronze
Ölgeschwartzte Bronze



825
Estaño cepillado
Etain brossé
Brushed tin
Zinn gebürstet



831
Bronce rústico
Bronze rustique
Antique brass
Bronze rustikal



836
Estaño rústico
Etain rustique
Rustic tin
Zinn rustikal

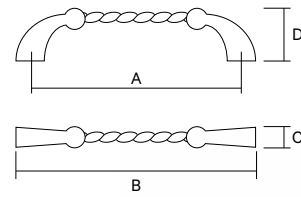

Rope

Zamak

	D	E
8581	23	34

Acabado / Finition / Finish / Oberfläche



100
Dorado brillo
Doré brillant
Gold plated
Glänzend vergoldet



500
Níquel mate
Nickel mat
Dull nickel
Matt Nickel



810
Negro petróleo
Noir pétrole
Oil rubbed bronze
Ölgeschwartzte Bronze



825
Estaño cepillado
Etain brossé
Brushed tin
Zinn gebürstet



831
Bronce rústico
Bronze rustique
Antique brass
Bronze rustikal



836
Estaño rústico
Etain rustique
Rustic tin
Zinn rustikal



Helix

Zamak

	A	B	C	D
7421	96	120	14	27
7422	64	81	11	22

Acabado / Finition / Finish / Oberfläche



805
Latón cepillado rústico
Laiton brossé rustique
Rustic brushed brass
Messing rustikal, gebürstet



807
Hierro rústico
Fer rustique
Rustic iron
Eisen rustikal



808
Cobre rústico
Cuivre rustique
Rustic copper
Kupfer rustikal



809
Níquel negro cepillado rústico
Nickelé noir brossé rustique
Black nickel rustic brushed
Nickel schwarz rustikal, gebürstet



831
Bronce rústico
Bronze rustique
Antique brass
Bronze rustikal



836
Estaño rústico
Etain rustique
Rustic tin
Zinn rustikal

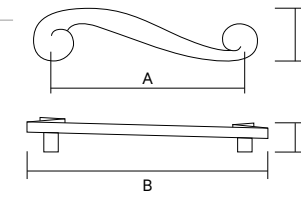

Helix

Zamak

	D	E
8871	25	30

Acabado / Finition / Finish / Oberfläche



805
Latón cepillado rústico
Laiton brossé rustique
Rustic brushed brass
Messing rustikal, gebürstet



807
Hierro rústico
Fer rustique
Rustic iron
Eisen rustikal



808
Cobre rústico
Cuivre rustique
Rustic copper
Kupfer rustikal



809
Níquel negro cepillado rústico
Nickelé noir brossé rustique
Black nickel rustic brushed
Nickel schwarz rustikal, gebürstet



831
Bronce rústico
Bronze rustique
Antique brass
Bronze rustikal



836
Estaño rústico
Etain rustique
Rustic tin
Zinn rustikal

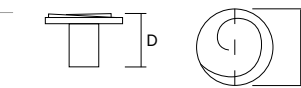

Reed

Zamak	B	C	D	E
8491	35	30	22	13x8

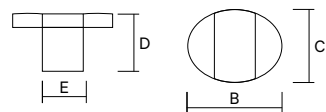

Reed

Zamak	A	B	C	D
7491	128	163	20	32
7492	96	128	16	27

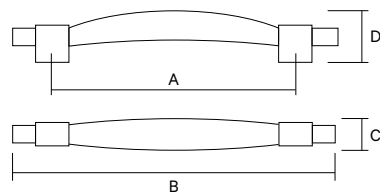

Acabado / Finition / Finish / Oberfläche

100 Dorado brillo Doré brillant Gold plated Glänzend vergoldet	500 Níquel mate Nickel mat Dull nickel Matt Nickel	810 Negro petróleo Noir pétrole Oil rubbed bronze Olgeschwärzte Bronze
825 Estaño cepillado Etain brossé Brushed tin Zinn gebürstet	831 Bronce rústico Bronze rustique Antique brass Bronze rustikal	836 Estaño rústico Etain rustique Rustic tin Zinn rustikal



Diabolo

Zamak	D	E
2880	35	60

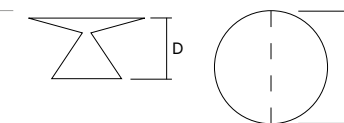

Acabado / Finition / Finish / Oberfläche

032 Negro mate Noir mat Dull black Mattschwarz	038 Níquel cepillado Nickel brossé Brushed Nickel Gebürstetes Nickel	292 Blanco mate Blanc mat Dull white Matt Weiß
400 Cromo brillo Chromé brillant Bright chrome Glänzend verchromt	800 Cromo mate Chromé mat Dull chrome Matt verchromt	831 Bronce rústico Bronze rustique Antique brass Bronze rustikal





Chess

Zamak	A	B	C	D
7191	128	161	21	25
7192	96	136	16	24

Acabado / Finition / Finish / Oberfläche

		
100 Dorado brillo Doré brillant Gold plated Glänzend vergoldet	500 Níquel mate Nickelé mat Dull nickel Matt Nickel	810 Negro petróleo Noir pétrole Oil rubbed bronze Ölgeschwartzte Bronze

		
825 Estaño cepillado Etain brossé Brushed tin Zinn gebürstet	831 Bronce rústico Bronze rustique Antique brass Bronze rustikal	836 Estaño rústico Etain rustique Rustic tin Zinn rustikal





Chess

Zamak	B	C	D	E
8191	34	34	24	10
8192	29	29	22	9

Acabado / Finition / Finish / Oberfläche

		
100 Dorado brillo Doré brillant Gold plated Glänzend vergoldet	500 Níquel mate Nickelé mat Dull nickel Matt Nickel	810 Negro petróleo Noir pétrole Oil rubbed bronze Ölgeschwartzte Bronze

		
825 Estaño cepillado Etain brossé Brushed tin Zinn gebürstet	831 Bronce rústico Bronze rustique Antique brass Bronze rustikal	836 Estaño rústico Etain rustique Rustic tin Zinn rustikal





Graph

Zamak	A	B	C	D
7371	128	178	22	31
7372	96	137	20	28

Acabado / Finition / Finish / Oberfläche

		
038 Níquel cepillado Nickelé brossé Brushed Nickel Gebürstetes Nickel	808 Cobre rústico Cuivre rustique Rustic copper Kupfer rustikal	809 Níquel negro cepillado rústico Nickelé noir brossé rustique Black nickel rustic brushed Nickel schwarz rustikal, gebürstet

	
831 Bronce rústico Bronze rustique Antique brass Bronze rustikal	836 Estaño rústico Etain rustique Rustic tin Zinn rustikal





Graph

Zamak	D	E
8841	26	34
8842	24	28

Acabado / Finition / Finish / Oberfläche

		
038 Níquel cepillado Nickelé brossé Brushed Nickel Gebürstetes Nickel	808 Cobre rústico Cuivre rustique Rustic copper Kupfer rustikal	809 Níquel negro cepillado rústico Nickelé noir brossé rustique Black nickel rustic brushed Nickel schwarz rustikal, gebürstet

	
831 Bronce rústico Bronze rustique Antique brass Bronze rustikal	836 Estaño rústico Etain rustique Rustic tin Zinn rustikal

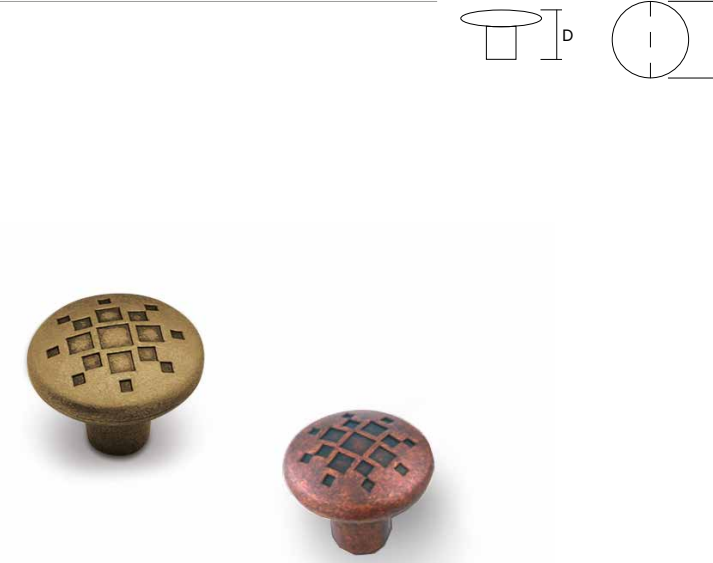

Osa

Porcelana-zamak / Porcelaine-zamak / Porcelain-zamak / Porzellan-Zamak

	A	B	C	D
7830	96	110	14	30

Acabado / Finition / Finish / Oberfläche



100
Dorado brillo
Doré brillant
Gold plated
Glänzend vergoldet



102
Blanco/Dorado brillo
Blanc/Doré brillant
White/Gold plated
Weiß/Glänzend vergoldet



831
Bronce rústico
Bronze rustique
Antique brass
Bronze rustikal



836
Estaño rústico
Etain rustique
Rustic tin
Zinn rustikal



900
Bronce viejo
Vieux bronze
Old bronze
Antik bronziert

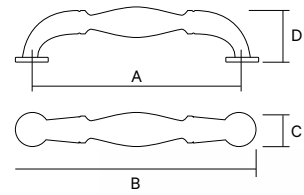

Buckle

Zamak

	A	B	C	D
7251	128	149	20	30
7252	96	117	18	26

Acabado / Finition / Finish / Oberfläche



038
Níquel cepillado
Nickelé brossé
Brushed Nickel
Gebürstetes Nickel



100
Dorado brillo
Doré brillant
Gold plated
Glänzend vergoldet



805
Latón cepillado rústico
Laiton brossé rustique
Rustic brushed brass
Messing rustikal, gebürstet



831
Bronce rústico
Bronze rustique
Antique brass
Bronze rustikal



836
Estaño rústico
Etain rustique
Rustic tin
Zinn rustikal

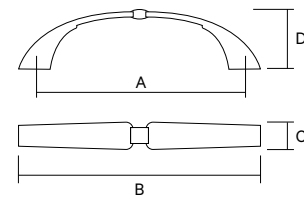

Wavy

Zamak

	D	E
8651	30	35
8652	25	30
8653	22	25

Acabado / Finition / Finish / Oberfläche



100
Dorado brillo
Doré brillant
Gold plated
Glänzend vergoldet



831
Bronce rústico
Bronze rustique
Antique brass
Bronze rustikal



836
Estaño rústico
Etain rustique
Rustic tin
Zinn rustikal



900
Bronce viejo
Vieux bronze
Old bronze
Antik bronziert

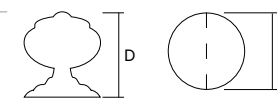

Liki

Porcelana-zamak / Porcelaine-zamak / Porcelain-zamak / Porzellan-Zamak

	A	B	C	D
9821	128	178	22	31
9822	96	137	20	28

Acabado / Finition / Finish / Oberfläche



805
Latón cepillado rústico
Laiton brossé rustique
Rustic brushed brass
Messing rustikal, gebürstet



831
Craquelé/Bronce rústico
Craquelé/Bronze rustique
Craquelé/Antique brass
Craquelé/Bronze rustikal

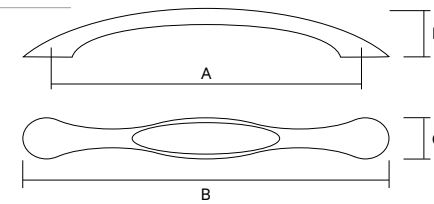

Liki

Porcelana-zamak / Porcelaine-zamak / Porcelain-zamak / Porzellan-Zamak

	D	E
9831	26	34
9832	24	28

Acabado / Finition / Finish / Oberfläche



805
Latón cepillado rústico
Laiton brossé rustique
Rustic brushed brass
Messing rustikal, gebürstet



831
Craquelé/Bronce rústico
Craquelé/Bronze rustique
Craquelé/Antique brass
Craquelé/Bronze rustikal

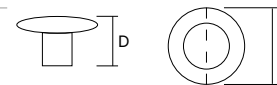

Hana

Porcelana-zamak / Porcelaine-zamak / Porcelain-zamak / Porzellan-Zamak

	A	B	C	D
9841	128	178	22	31
9842	96	137	20	28

Acabado / Finition / Finish / Oberfläche



805

Latón cepillado rústico
Laiton brossé rustique
Rustic brushed brass
Messing rustikal, gebürstet



831

Marfil, decorada/Bronce rústico
Ivoire, décorée/Bronze rustique
Ivory, decorated/Antique brass
Elfenbein, dekoriert/Bronze rustikal

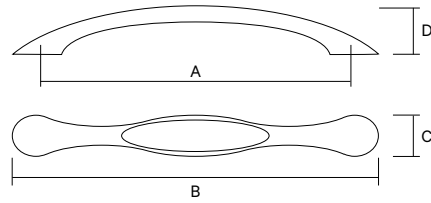

Hana

Porcelana-zamak / Porcelaine-zamak / Porcelain-zamak / Porzellan-Zamak

	D	E
9851	26	34
9852	24	28

Acabado / Finition / Finish / Oberfläche



805

Latón cepillado rústico
Laiton brossé rustique
Rustic brushed brass
Messing rustikal, gebürstet



831

Marfil, decorada/Bronce rústico
Ivoire, décorée/Bronze rustique
Ivory, decorated/Antique brass
Elfenbein, dekoriert/Bronze rustikal

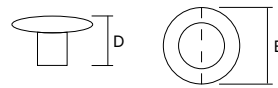

Vlak

Porcelana-zamak / Porcelaine-zamak / Porcelain-zamak / Porzellan-Zamak

	A	B	C	D
9700	96	110	14	31

Acabado / Finition / Finish / Oberfläche



102

Blanco/Dorado brillo
Blanc/Doré brillant
White/Gold plated
Weiß/Glänzend vergoldet



836

Blanco/Estaño rústico
Blanc/Etain rustique
White/Rustic tin
Weiß/Zinn rustikal



902

Blanco/Bronce viejo
Blanc/Vieux bronze
White/Old bronze
Weiß/Antik bronziert

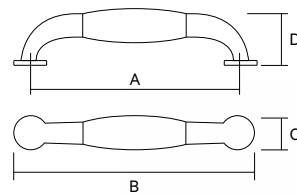

Gele

Porcelana-zamak / Porcelaine-zamak / Porcelain-zamak / Porzellan-Zamak

	A	B	C	D
9770	96	110	14	31

Acabado / Finition / Finish / Oberfläche



109

Marfil, decorada/Dorado brillo
Ivoire, décorée/Doré brillant
Ivory, decorated/Gold plated
Elfenbein, dekoriert/Glänzend vergoldet



831

Marfil, decorada/Bronce rústico
Ivoire, décorée/Bronze rustique
Ivory, decorated/Antique brass
Elfenbein, dekoriert/Bronze rustikal



836

Marfil, decorada/Estaño rústico
Ivoire, décorée/Etain rustique
Ivory, decorated/Rustic tin
Elfenbein, dekoriert/Zinn rustikal



909

Marfil, decorada/Bronce viejo
Ivoire, décorée/Vieux bronze
Ivory, decorated/Old bronze
Elfenbein, dekoriert/Antik bronziert

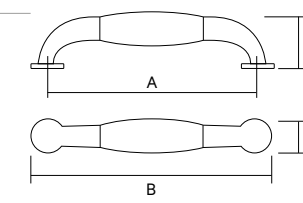

Gele

Porcelana-zamak / Porcelaine-zamak / Porcelain-zamak / Porzellan-Zamak

	D	E
9771	28	37
9772	23	30

Acabado / Finition / Finish / Oberfläche



109

Marfil, decorada/Dorado brillo
Ivoire, décorée/Doré brillant
Ivory, decorated/Gold plated
Elfenbein, dekoriert/Glänzend vergoldet



831

Marfil, decorada/Bronce rústico
Ivoire, décorée/Bronze rustique
Ivory, decorated/Antique brass
Elfenbein, dekoriert/Bronze rustikal



836

Marfil, decorada/Estaño rústico
Ivoire, décorée/Etain rustique
Ivory, decorated/Rustic tin
Elfenbein, dekoriert/Zinn rustikal



909

Marfil, decorada/Bronce viejo
Ivoire, décorée/Vieux bronze
Ivory, decorated/Old bronze
Elfenbein, dekoriert/Antik bronziert

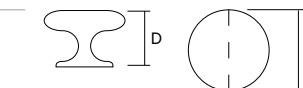

Beo

Porcelana-zamak / Porcelaine-zamak / Porcelain-zamak / Porzellan-Zamak

	D	E
9651	28	38
9652	26	32

Acabado / Finition / Finish / Oberfläche



002

Blanco
Blanc
White
Weiß

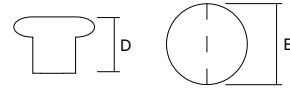

Zuri

Porcelana-zamak / Porcelaine-zamak / Porcelain-zamak / Porzellan-Zamak

	D	E
9501	28	37
9502	23	30

Acabado / Finition / Finish / Oberfläche



102

Blanco/Dorado brillo
Blanc/Doré brillant
White/Gold plated
Weiß/Glänzend vergoldet

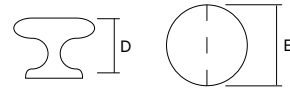

Hat

Porcelana-zamak / Porcelaine-zamak / Porcelain-zamak / Porzellan-Zamak

	D	E
9551	30	37
9552	25	30

Acabado / Finition / Finish / Oberfläche



102

Blanco/Dorado brillo
Blanc/Doré brillant
White/Gold plated
Weiß/Glänzend vergoldet



902

Blanco/Bronce viejo
Blanc/Vieux bronze
White/Old bronze
Weiß/Antik bronziert

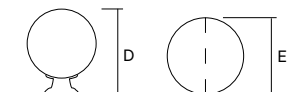
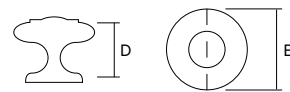

Shine

Cristal-latón / Cristal-laiton / Crystal-brass / Kristall-Messing

	D	E
9991	48	35
9992	42	30
9993	35	25

Acabado / Finition / Finish / Oberfläche



100

Transparente/Dorado brillo
Transparent/Doré brillant
Transparent/Gold plated
Transparent/Glänzend vergoldet



400

Transparente/Cromo brillo
Transparent/Chromé brillant
Transparent/Bright chrome
Transparent/Glänzend verchromt

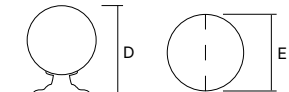

Lux

Cristal "strass"-latón / Cristal "strass"-laiton / "Strass" crystal-brass / "Strass" Kristall-Messing

	D	E
9932	40	30
9933	30	25

Acabado / Finition / Finish / Oberfläche



100

Transparente/Dorado brillo
Transparent/Doré brillant
Transparent/Gold plated
Transparent/Glänzend vergoldet



404

Transparente/Cromo brillo
Transparent/Chromé brillant
Transparent/Bright chrome
Transparent/Glänzend verchromt



Made with Swarovski® elements

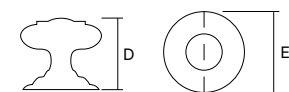

Lux

Cristal "strass"-latón / Cristal "strass"-laiton / "Strass" crystal-brass / "Strass" Kristall-Messing

	D	E
9952	26	30
9953	23	25

Acabado / Finition / Finish / Oberfläche



100

Transparente/Dorado brillo
Transparent/Doré brillant
Transparent/Gold plated
Transparent/Glänzend vergoldet



404

Transparente/Cromo brillo
Transparent/Chromé brillant
Transparent/Bright chrome
Transparent/Glänzend verchromt



Made with Swarovski® elements

Patch

Nylon			
	B	C	D
5611	40	40	20

Acabado / Finition / Finish / Oberfläche



000

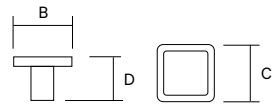

Patch

Nylon			
	B	C	D
5612	40	40	20

Acabado / Finition / Finish / Oberfläche



000

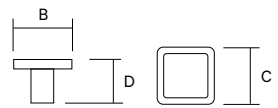

Clover

Nylon			
	B	C	D
5613	43	43	20

Acabado / Finition / Finish / Oberfläche



000



Flower

Nylon			
	B	C	D
5614	50	50	20

Acabado / Finition / Finish / Oberfläche



000

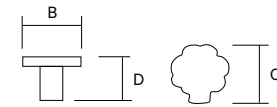
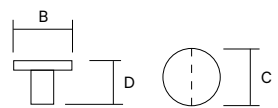

Tree

Nylon			
	B	C	D
5615	47	51	20

Acabado / Finition / Finish / Oberfläche



000

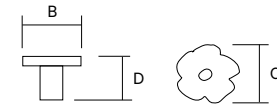

Rose

Nylon			
	B	C	D
5616	50	50	20

Acabado / Finition / Finish / Oberfläche



000

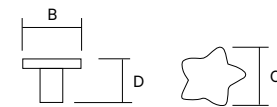

Star

Nylon			
	B	C	D
5617	50	50	20

Acabado / Finition / Finish / Oberfläche



000

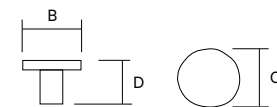

Heart

Nylon			
	B	C	D
5618	50	48	20

Acabado / Finition / Finish / Oberfläche



000

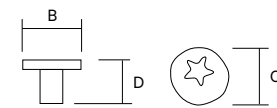

Whitestar

Nylon			
	B	C	D
5619	50	50	20

Acabado / Finition / Finish / Oberfläche



000

Elephant

Nylon

	B	C	D
5621	41	44	20

Acabado / Finition / Finish / Oberfläche



000

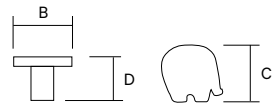

Bear

Nylon

	B	C	D
5622	38	47	20

Acabado / Finition / Finish / Oberfläche



000

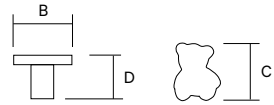

Bunny

Nylon

	B	C	D
5623	35	58	20

Acabado / Finition / Finish / Oberfläche



000

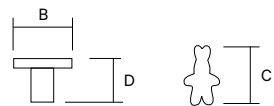

Butterfly

Nylon

	B	C	D
5624	45	42	20

Acabado / Finition / Finish / Oberfläche



000



Frog

Nylon

	B	C	D
5625	51	35	20

Acabado / Finition / Finish / Oberfläche



000

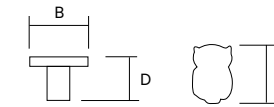
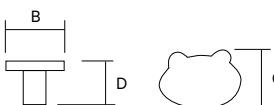

Owl

Nylon

	B	C	D
5626	34	49	20

Acabado / Finition / Finish / Oberfläche



000

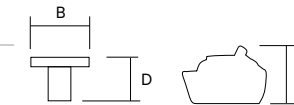

Ship

Nylon

	B	C	D
5627	50	35	20

Acabado / Finition / Finish / Oberfläche



000

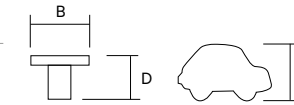

Car

Nylon

	B	C	D
5628	50	31	20

Acabado / Finition / Finish / Oberfläche



000

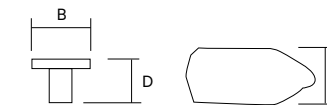

Pencil

Nylon

	B	C	D
5629	51	23	20

Acabado / Finition / Finish / Oberfläche



000

Unix Duo

Acero inoxidable-zamak / Acier inox-zamak / Stainless steel-zamak / Rostfreier Stahl-Zamak

	A	B	C	D
7511	320	333	25	38
7512	256	269	25	38
7513	192	205	25	38

Acabado / Finition / Finish / Oberfläche



031

Inoxidable cepillado
Inox brossé
Brushed stainless
Rostfreier Stahl, gebürstet

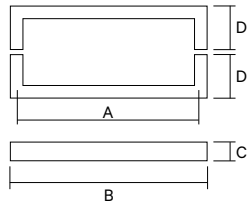
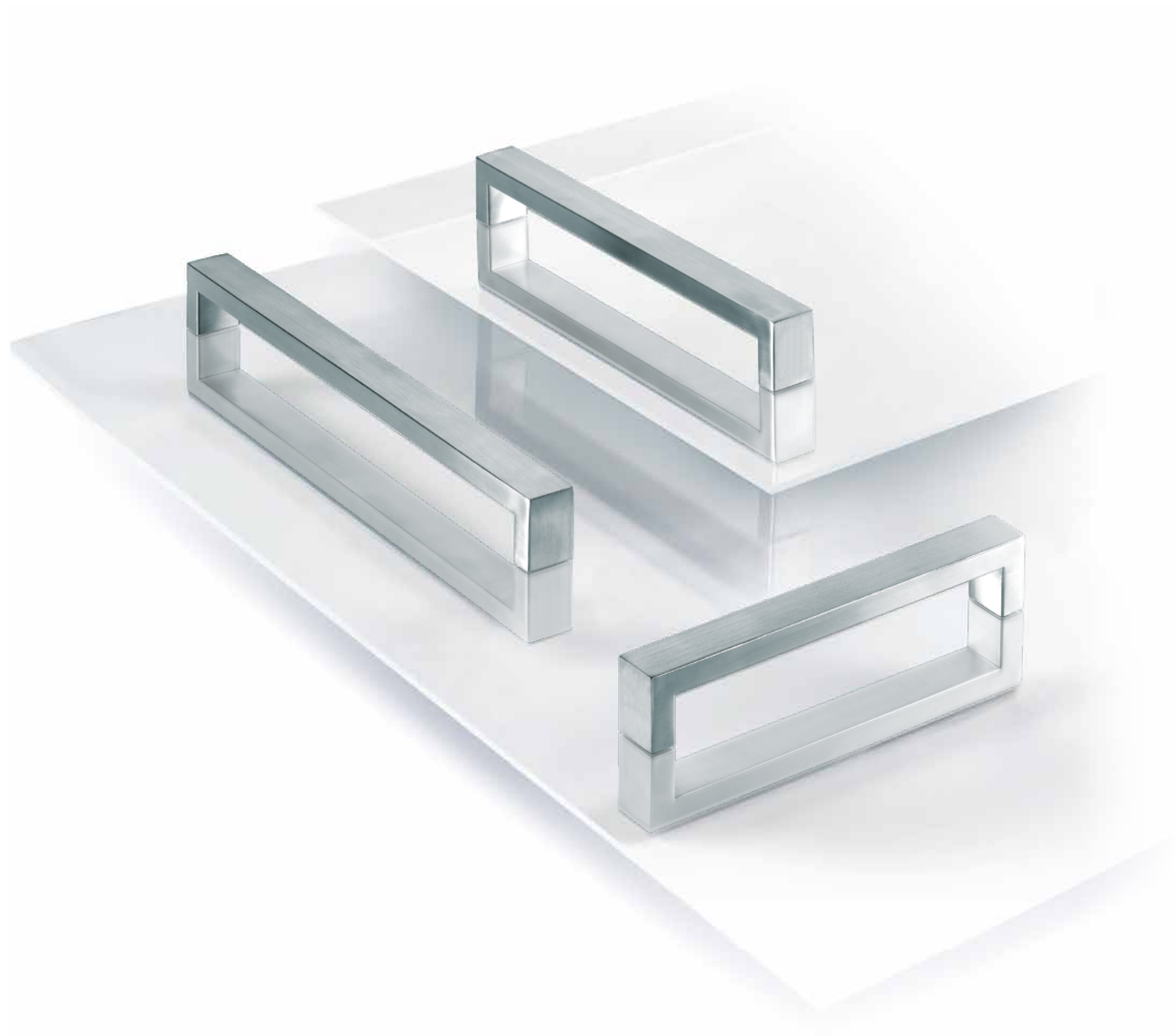
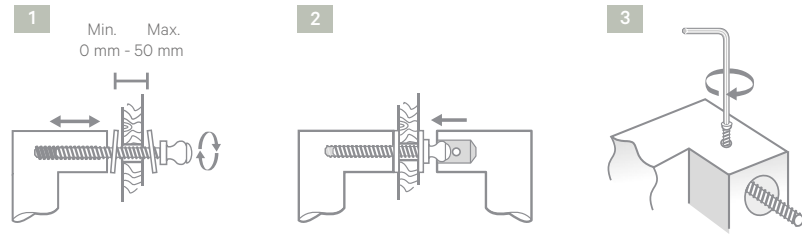

Grip

Zamak

	A	B	C	D
2211	300	317	25	52
2212	200	217	25	48

Acabado / Finition / Finish / Oberfläche



038

Níquel cepillado
Nickel brossé
Brushed Nickel
Gebürstetes Nickel



400

Cromo brillo
Chromé brillant
Bright chrome
Glänzend verchromt

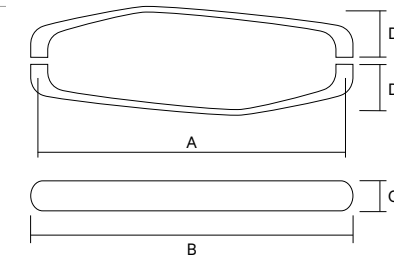
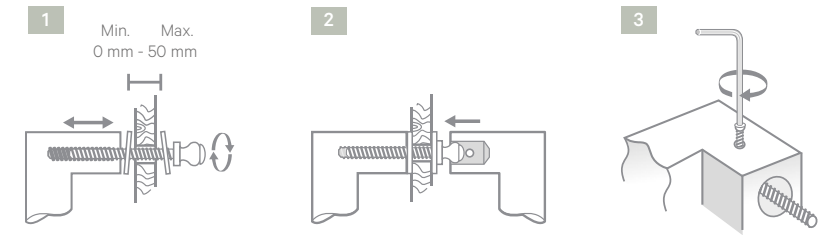
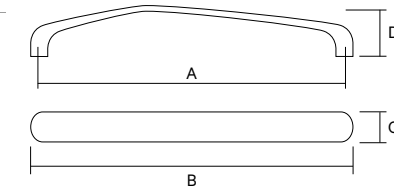

Grip

Zamak

	A	B	C	D
2111	300	317	25	52
2112	200	217	25	48

Acabado / Finition / Finish / Oberfläche



038

Níquel cepillado
Nickel brossé
Brushed Nickel
Gebürstetes Nickel



400

Cromo brillo
Chromé brillant
Bright chrome
Glänzend verchromt

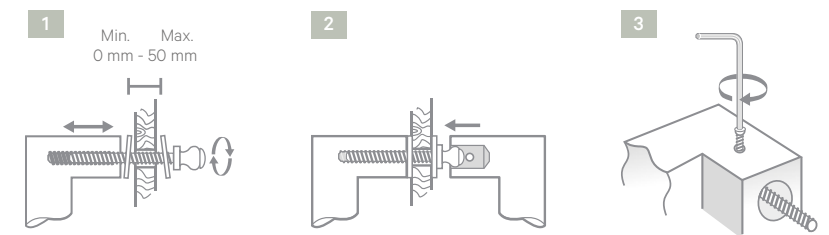

Bolt

Zamak	A	B	C	D	E	F	G
2000	140	69	45	22	22	19	32

Acabado / Finition / Finish / Oberfläche



100
Dorado brillo
Doré brillant
Gold plated
Glänzend vergoldet



200
Dorado satinado
Doré satiné
Satin gold plated
Satiniertes gold



400
Cromo brillo
Chromé brillant
Bright chrome
Glänzend verchromt



800
Cromo mate
Chromé mat
Dull chrome
Matt verchromt



900
Bronce viejo
Vieux bronze
Old bronze
Antik bronziert

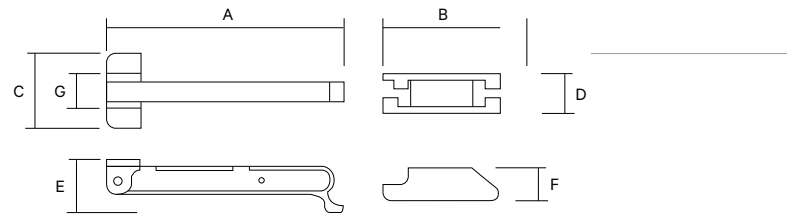

Icons

Acero inoxidable-zamak / Acier inox-zamak / Stainless steel-zamak / Rostfreier Stahl-Zamak

	B	C	D
1101	100	100	2

Acabado / Finition / Finish / Oberfläche



031
Inoxidable cepillado
Inox brossé
Brushed stainless
Rostfreier Stahl, gebürstet

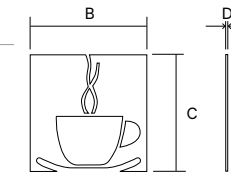

Icons

Acero inoxidable-zamak / Acier inox-zamak / Stainless steel-zamak / Rostfreier Stahl-Zamak

	B	C	D
1102	100	100	2

Acabado / Finition / Finish / Oberfläche



031
Inoxidable cepillado
Inox brossé
Brushed stainless
Rostfreier Stahl, gebürstet

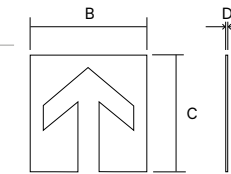

Icons

Acero inoxidable-zamak / Acier inox-zamak / Stainless steel-zamak / Rostfreier Stahl-Zamak

	B	C	D
1103	100	100	2

Acabado / Finition / Finish / Oberfläche



031
Inoxidable cepillado
Inox brossé
Brushed stainless
Rostfreier Stahl, gebürstet

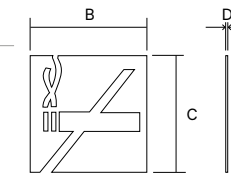

Icons

Acero inoxidable-zamak / Acier inox-zamak / Stainless steel-zamak / Rostfreier Stahl-Zamak

	B	C	D
1104	100	100	2

Acabado / Finition / Finish / Oberfläche



031
Inoxidable cepillado
Inox brossé
Brushed stainless
Rostfreier Stahl, gebürstet

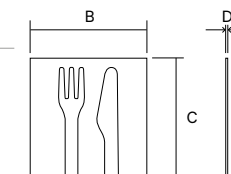

Icons

Acero inoxidable-zamak / Acier inox-zamak / Stainless steel-zamak / Rostfreier Stahl-Zamak

	B	C	D
1105	100	100	2

Acabado / Finition / Finish / Oberfläche



031
Inoxidable cepillado
Inox brossé
Brushed stainless
Rostfreier Stahl, gebürstet

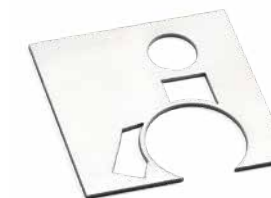
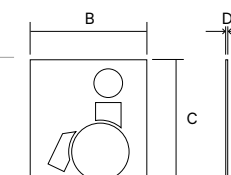

Icons

Acero inoxidable-zamak / Acier inox-zamak / Stainless steel-zamak / Rostfreier Stahl-Zamak

	B	C	D
1106	100	100	2

Acabado / Finition / Finish / Oberfläche

 Inoxidable cepillado
Inox brossé
Brushed stainless
Rostfreier Stahl, gebürstet

031

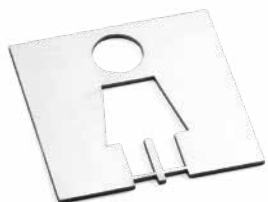
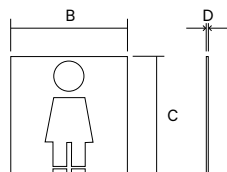

Icons

Acero inoxidable-zamak / Acier inox-zamak / Stainless steel-zamak / Rostfreier Stahl-Zamak

	B	C	D
1107	100	100	2

Acabado / Finition / Finish / Oberfläche

 Inoxidable cepillado
Inox brossé
Brushed stainless
Rostfreier Stahl, gebürstet

031

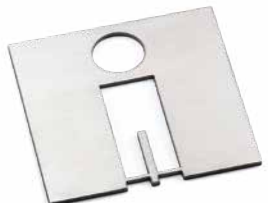
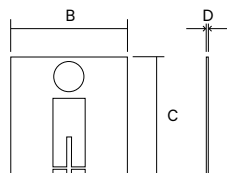

Icons

Acero inoxidable-zamak / Acier inox-zamak / Stainless steel-zamak / Rostfreier Stahl-Zamak

	B	C	D
1108	100	100	2

Acabado / Finition / Finish / Oberfläche

 Inoxidable cepillado
Inox brossé
Brushed stainless
Rostfreier Stahl, gebürstet

031

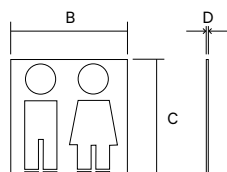

Icons

Acero inoxidable-zamak / Acier inox-zamak / Stainless steel-zamak / Rostfreier Stahl-Zamak

	B	C	D
1109	100	100	2

Acabado / Finition / Finish / Oberfläche

 Inoxidable cepillado
Inox brossé
Brushed stainless
Rostfreier Stahl, gebürstet

031

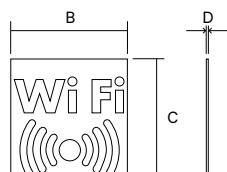

Instalación con cinta adhesiva de doble cara incluida en el blister.
Installation avec ruban adhésif double-face inclu dans le blister.
Installation with double sided adhesive tape included in blister.
Montage mittels doppelseitigem Klebeband, im Blister enthalten.

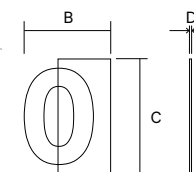

Icons

Acero inoxidable-zamak / Acier inox-zamak / Stainless steel-zamak / Rostfreier Stahl-Zamak

	B	C	D
1000	80	125	2
1020	20	75	2

Acabado / Finition / Finish / Oberfläche

 Inoxidable cepillado
Inox brossé
Brushed stainless
Rostfreier Stahl, gebürstet

031

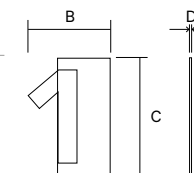

Icons

Acero inoxidable-zamak / Acier inox-zamak / Stainless steel-zamak / Rostfreier Stahl-Zamak

	B	C	D
1001	60	125	2
1021	30	75	2

Acabado / Finition / Finish / Oberfläche

 Inoxidable cepillado
Inox brossé
Brushed stainless
Rostfreier Stahl, gebürstet

031

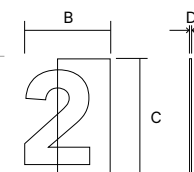

Icons

Acero inoxidable-zamak / Acier inox-zamak / Stainless steel-zamak / Rostfreier Stahl-Zamak

	B	C	D
1002	80	125	2
1022	20	75	2

Acabado / Finition / Finish / Oberfläche

 Inoxidable cepillado
Inox brossé
Brushed stainless
Rostfreier Stahl, gebürstet

031

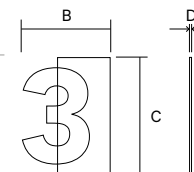

Icons

Acero inoxidable-zamak / Acier inox-zamak / Stainless steel-zamak / Rostfreier Stahl-Zamak

	B	C	D
1003	80	125	2
1023	20	75	2

Acabado / Finition / Finish / Oberfläche

 Inoxidable cepillado
Inox brossé
Brushed stainless
Rostfreier Stahl, gebürstet

031

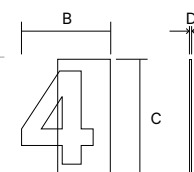

Icons

Acero inoxidable-zamak / Acier inox-zamak / Stainless steel-zamak / Rostfreier Stahl-Zamak

	B	C	D
1004	80	125	2
1024	20	75	2

Acabado / Finition / Finish / Oberfläche

 Inoxidable cepillado
Inox brossé
Brushed stainless
Rostfreier Stahl, gebürstet

031

Icons

Acero inoxidable-zamak / Acier inox-zamak / Stainless steel-zamak / Rostfreier Stahl-Zamak

	B	C	D
1005	80	125	2
1025	20	75	2

Acabado / Finition / Finish / Oberfläche

 Inoxidable cepillado
Inox brossé
Brushed stainless
Rostfreier Stahl, gebürstet

031

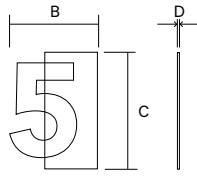

Icons

Acero inoxidable-zamak / Acier inox-zamak / Stainless steel-zamak / Rostfreier Stahl-Zamak

	B	C	D
1006	80	125	2
1026	20	75	2

Acabado / Finition / Finish / Oberfläche

 Inoxidable cepillado
Inox brossé
Brushed stainless
Rostfreier Stahl, gebürstet

031

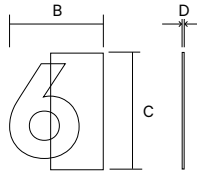

Icons

Acero inoxidable-zamak / Acier inox-zamak / Stainless steel-zamak / Rostfreier Stahl-Zamak

	B	C	D
1007	80	125	2
1027	20	75	2

Acabado / Finition / Finish / Oberfläche

 Inoxidable cepillado
Inox brossé
Brushed stainless
Rostfreier Stahl, gebürstet

031

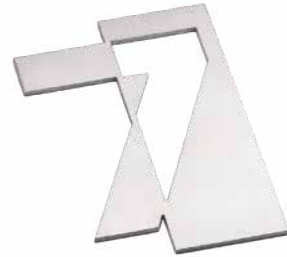
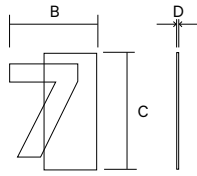

Icons

Acero inoxidable-zamak / Acier inox-zamak / Stainless steel-zamak / Rostfreier Stahl-Zamak

	B	C	D
1008	80	125	2
1028	20	75	2

Acabado / Finition / Finish / Oberfläche

 Inoxidable cepillado
Inox brossé
Brushed stainless
Rostfreier Stahl, gebürstet

031

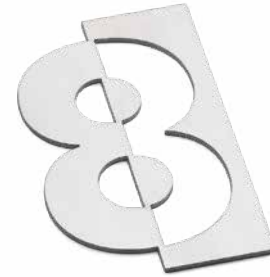
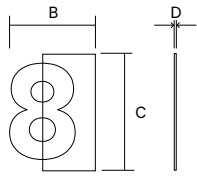

Icons

Acero inoxidable-zamak / Acier inox-zamak / Stainless steel-zamak / Rostfreier Stahl-Zamak

	B	C	D
1009	80	125	2
1029	20	75	2

Acabado / Finition / Finish / Oberfläche

 Inoxidable cepillado
Inox brossé
Brushed stainless
Rostfreier Stahl, gebürstet

031

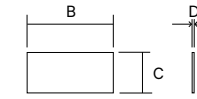
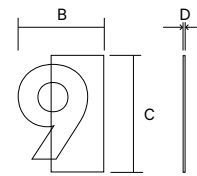

Icons

Acero inoxidable-zamak / Acier inox-zamak / Stainless steel-zamak / Rostfreier Stahl-Zamak

	B	C	D
1030	20	10	2

Acabado / Finition / Finish / Oberfläche

 Inoxidable cepillado
Inox brossé
Brushed stainless
Rostfreier Stahl, gebürstet

031

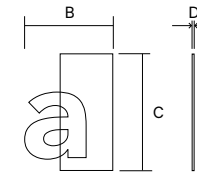

Icons

Acero inoxidable-zamak / Acier inox-zamak / Stainless steel-zamak / Rostfreier Stahl-Zamak

	B	C	D
102A	40	75	2

Acabado / Finition / Finish / Oberfläche

 Inoxidable cepillado
Inox brossé
Brushed stainless
Rostfreier Stahl, gebürstet

031

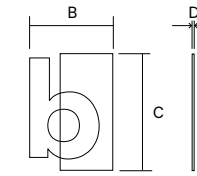

Icons

Acero inoxidable-zamak / Acier inox-zamak / Stainless steel-zamak / Rostfreier Stahl-Zamak

	B	C	D
102B	40	75	2

Acabado / Finition / Finish / Oberfläche

 Inoxidable cepillado
Inox brossé
Brushed stainless
Rostfreier Stahl, gebürstet

031



En blister packs con elementos de fijación incluidos.
Dans des blisters, tous les éléments de fixation inclus.
In blisters, all fitting elements included.
In Blisterverpackung, Befestigungselemente eingeschlossen.

Instalación con cinta adhesiva de doble cara incluida en el blister.
Installation avec ruban adhésif double-face inclus dans le blister.
Installation with double sided adhesive tape included in blister.
Montage mittels doppelseitigem Klebeband, im Blister enthalten.



Montaje para números de 125mm
Montage pour numéros de 125mm
Set up for numbers 125mm
Befestigungsanleitung von Ziffern in 125mm

Icons

Acero inoxidable-zamak / Acier inox-zamak / Stainless steel-zamak / Rostfreier Stahl-Zamak

	B	C	D
102C	40	75	2

Acabado / Finition / Finish / Oberfläche

Inoxidable cepillado
Inox brossé
Brushed stainless
Rostfreier Stahl, gebürstet

031

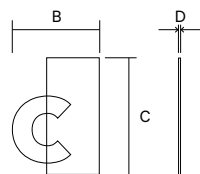

Icons

Acero inoxidable-zamak / Acier inox-zamak / Stainless steel-zamak / Rostfreier Stahl-Zamak

	B	C	D
102D	40	75	2

Acabado / Finition / Finish / Oberfläche

Inoxidable cepillado
Inox brossé
Brushed stainless
Rostfreier Stahl, gebürstet

031

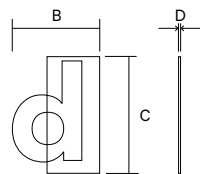

Icons

Acero inoxidable-zamak / Acier inox-zamak / Stainless steel-zamak / Rostfreier Stahl-Zamak

	B	C	D
102E	40	75	2

Acabado / Finition / Finish / Oberfläche

Inoxidable cepillado
Inox brossé
Brushed stainless
Rostfreier Stahl, gebürstet

031

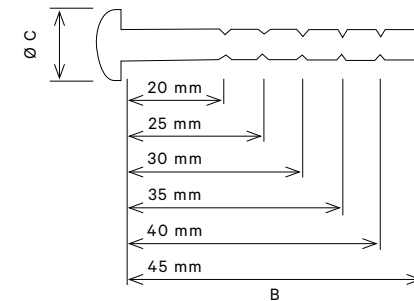
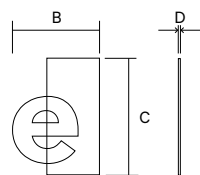

Tornillo multilargo Vis multilongueur Multisize screw Multilängen-Schrauben

Hierro / Fer / Iron / Eisen

	A	B	C	D
M-45		20-45	9	

Acabado / Finition / Finish / Oberfläche



000
Zincado
Zingué
Zinc
Verzinkt

Tornillo multilargo de corte limpio que siempre rosca. Nuestros herrajes Estamp llevan incorporados este tipo de tornillo. Vis multilongueur qui se coupe facilement sans abîmer le filetage. Nos articles Estamp portent tous ce type de vis. Multisize screw clean cut that always screws. Our Estamp fittings include this kind of screw.

Multilängen-Schraube immer gängig dank dem sauberen Gewindeschnitt. Unsere Estamp Möbelbeschläge werden mit diesem Schraubentyp geliefert.

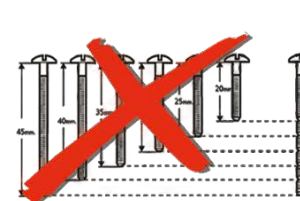

✓ **Reduzca la inversión**
En inmovilizado y el riesgo de restos invendibles sustituyendo los tornillos de diversas longitudes por el tornillo multilargo Estamp.

✓ **Reduisez l'investissement**
Des stocks immobilisés et le risque d'invendus en remplaçant les vis de différentes longueurs par une seule vis multilongueur Estamp.

✓ **Reduce investment**
In stocks and risk of not saleable rests substituting screws of different lengths with Estamp multisize screw.

✓ **Reduzieren sie Ihre Investitionen**
In Anlagen und vermeiden Sie das Risiko, auf unverkäuflichen Resten sitzen zu bleiben. Verwenden Sie anstatt Schrauben verschiedener Längen die Estamp Multilängen-Schraube.



✓ **Reduzca espacio**
De almacenaje manteniendo en stock una sola longitud de tornillo.

✓ **Reduisez le volume**
De stockage en disposant d'une seule longueur de vis.

✓ **Reduce Space**
For storage keeping only one length of screw.

✓ **Geringerer Lager-Platzbedarf**
Dank einer einzigen Schraubenlänge.

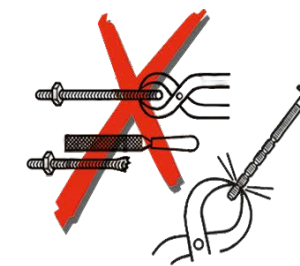

✓ **Reduzca el gasto**
En mano de obra eliminando el limado de espárragos tradicionales al utilizar el tornillo multilargo Estamp de corte limpio y roscado directo.

✓ **Reduisez les frais**
De main-d'oeuvre pour le limage des tiges traditionnelles en utilisant la vis Estamp multilongueur de coupe facile et directe vis.

✓ **Reduce expenses**
On labour eliminating filing of traditional screw by using multisize Estamp screws of clean cut and direct screw.

✓ **Reduzieren sie Ihre Lohkosten**
Die sauber geschnittene, direktgängige Estamp Multilängenschraube macht das herkömmliche Steh-schraubenfeilen überflüssig.

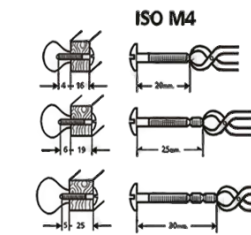

✓ **Adaptable**
A los gruesos de madera utilizados en carpintería y ebanistería. Nuestros herrajes Estamp llevan incorporados este tipo de tornillo.

✓ **Adaptable**
À toutes les épaisseurs de bois utilisés en menuiserie et en ébénisterie. Nos articles Estamp portent tous ce type de vis.

✓ **Adaptable**
To different thicknesses of wood used in carpentry and woodwork industry. Our fittings Estamp are fitted with this kind of screw.

✓ **Anpassungsfähig**
Für alle in der Tischlerei und Schreinerei gebräuchlichen Holzdicken geeignet. Unsere Estamp Möbelbeschläge werden mit diesem Schraubentyp geliefert.

Cierres a presión Fermetures à pression Pressure locks Druckverschlüsse

Nylon

231	Para puertas grandes / Pour grandes portes / For large doors / Für grosse Türen
232	Para puertas pequeñas / Pour petites portes / For small doors / Für kleine Türen

Acabado / Finition / Finish / Oberfläche



000

Nylon
Nylon
Nylon
Nylon

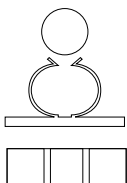

Tornillos Vis Screws Schrauben

Hierro / Fer / Iron / Eisen

	A	B	C	D
T-14		14	9	
T-21		21	9	
T-25		25	9	
T-31		31	9	
T-35		35	9	
T-40		40	9	
T-60		60	9	

Acabado / Finition / Finish / Oberfläche



000

Bicromatado
Bichromaté
Zinc-yellow
Bichromatiert

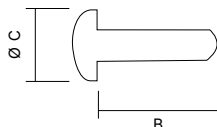

Espárrago rosca madera Tiges filetées pour bois Wood screw Gewindeschraube für Holz

Hierro / Fer / Iron / Eisen

	A	B	C	D
ED-15	22			

Acabado / Finition / Finish / Oberfläche



000

Bicromatado
Bichromaté
Zinc-yellow
Bichromatiert

